

Relay Module - PLC-RPT-120UC/21HC - 2900296

Please be informed that the data shown in this PDF Document is generated from our Online Catalog. Please find the complete data in the user's documentation. Our General Terms of Use for Downloads are valid (<http://phoenixcontact.com/download>)



PLC-INTERFACE for high continuous currents, consisting of PLC-BPT.../21 HC basic terminal block with push-in connection and plug-in miniature relay, for mounting on DIN rail NS 35/7,5, limiting continuous current up to 10 A, 1 PDT, input voltage 120 V AC/DC

The figure shows a version with a screw connection

Product Features

- Efficient connection to system cabling using V8 adapter
- All common input voltages of 12 V DC to 230 V AC
- Long electrical service life thanks to 16 A relay
- Safe isolation according to DIN EN 50178 between coil and contact
- Max. continuous current of 10 A
- Functional plug-in bridges



Key Commercial Data

Packing unit	1 pc
Weight per Piece (excluding packing)	66.0 g
Custom tariff number	85364900
Country of origin	Germany

Technical data

Note

Utilization restriction	EMC: class A product, see manufacturer's declaration in the download area
-------------------------	---

Dimensions

Width	14 mm
Height	80 mm
Depth	94 mm

Relay Module - PLC-RPT-120UC/21HC - 2900296

Technical data

Ambient conditions

Ambient temperature (operation)	-40 °C ... 60 °C
Ambient temperature (storage/transport)	-40 °C ... 85 °C

Coil side

Nominal input voltage U_N	120 V AC
	110 V DC
Typical input current at U_N	4.2 mA (at 110 V DC)
	4.5 mA (for 120 V AC)
Typical response time	7 ms
Typical release time	10 ms
Protective circuit	Bridge rectifier Bridge rectifier
Operating voltage display	Yellow LED
Power dissipation for nominal condition	0.54 W

Contact side

Contact type	1 PDT
Contact material	AgNi
Maximum switching voltage	250 V AC/DC (The separating plate PLC-ATP should be installed for voltages larger than 250 V (L1, L2, L3) between identical terminal blocks in adjacent modules. Potential bridging is then carried out with FBST 8-PLC... or ...FBST 500...)
Minimum switching voltage	12 V (at 10 mA)
Min. switching current	10 mA (at 12 V)
Maximum inrush current	30 A (300 ms)
Limiting continuous current	10 A
	6 A (value applies to connections 12. If connections 12 are bridged, the normal value applies.)
Interrupting rating (ohmic load) max.	240 W (at 24 V DC)
	58 W (at 48 V DC)
	48 W (at 60 V DC)
	50 W (at 110 V DC)
	80 W (at 220 V DC)
	2500 VA (for 250 V AC)
Interrupting rating (ohmic load) max. bridged	144 W (for 24 V DC. Value applies to connections 12. If connections 12 are bridged, the normal value applies.)
	1500 VA (for 250 V AC. Value applies to connections 12. If connections 12 are bridged, the normal value applies.)
Switching capacity in acc. with DIN VDE 0660/IEC 60947	2 A (at 24 V, DC13)
	0.2 A (at 110 V, DC13)
	0.2 A (at 250 V, DC13)

Relay Module - PLC-RPT-120UC/21HC - 2900296

Technical data

Contact side

	6 A (at 24 V, AC15)
	6 A (at 120 V, AC15)
	6 A (at 250 V, AC15)

Connection data input side

Connection name	Coil side
Connection method	Push-in connection
Stripping length	8 mm
Conductor cross section solid	0.14 mm ² ... 2.5 mm ²
Conductor cross section flexible	0.14 mm ² ... 2.5 mm ²
Conductor cross section AWG	26 ... 14

Connection data output side

Connection name	Contact side
Connection method	Push-in connection
Stripping length	8 mm
Conductor cross section solid	0.14 mm ² ... 2.5 mm ²
Conductor cross section flexible	0.14 mm ² ... 2.5 mm ²
Conductor cross section AWG	26 ... 14

General

Operating mode	100% operating factor
Degree of protection	RT II (Relay)
Mechanical service life	3 x 10 ⁷ cycles
Flammability rating according to UL 94	V0
Designation	Standards/regulations
Standards/regulations	IEC 60664
	EN 50178
	IEC 62103
Rated surge voltage/insulation	6 kV / Safe isolation, increased insulation
Degree of pollution	2
Overvoltage category	III
Mounting position	any
Assembly instructions	In rows with zero spacing

Standards and Regulations

Connection in acc. with standard	CUL
Designation	Standards/regulations
Standards/regulations	IEC 60664

Relay Module - PLC-RPT-120UC/21HC - 2900296

Technical data

Standards and Regulations

	EN 50178
	IEC 62103
Rated surge voltage/insulation	6 kV / Safe isolation, increased insulation
Degree of pollution	2
Overvoltage category	III
Flammability rating according to UL 94	V0

Articles in set

Relay socket - PLC-BPT-120UC/21HC - 2900258



14 mm PLC basic terminal block for high continuous currents with push-in connection, without relay or solid-state relay, for mounting on DIN rail NS 35/7,5, 1 PDT, input voltage 120 V AC/DC

Single relay - REL-MR-110DC/21HC - 2961338



Plug-in miniature power relay, with power contact for high continuous currents, 1 PDT, input voltage 110 V DC

Classifications

eCl@ss

eCl@ss 4.0	27371001
eCl@ss 4.1	27371001
eCl@ss 5.0	27371001
eCl@ss 5.1	27371001
eCl@ss 6.0	27371001
eCl@ss 7.0	27371001
eCl@ss 8.0	27371601
eCl@ss 9.0	27371601

ETIM

ETIM 4.0	EC000196
----------	----------

Relay Module - PLC-RPT-120UC/21HC - 2900296

Classifications

ETIM

ETIM 5.0	EC001437
----------	----------

UNSPSC

UNSPSC 6.01	30211916
UNSPSC 7.0901	39121515
UNSPSC 11	39121515
UNSPSC 12.01	39121515
UNSPSC 13.2	39121515

Approvals

Approvals

Approvals

GL / UL Listed / cUL Listed / UL Recognized / cUL Recognized / EAC / RC FRT / cULus Recognized / cULus Listed

Ex Approvals

Approvals submitted

Approval details

GL

UL Listed

cUL Listed

UL Recognized

Relay Module - PLC-RPT-120UC/21HC - 2900296

Approvals

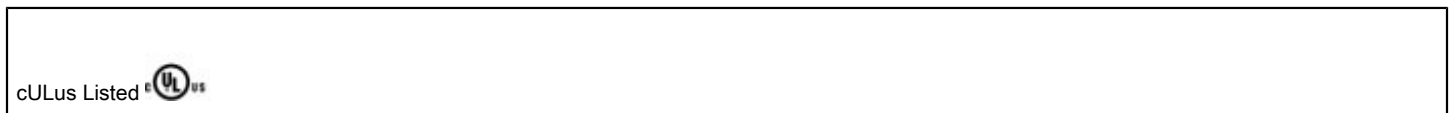
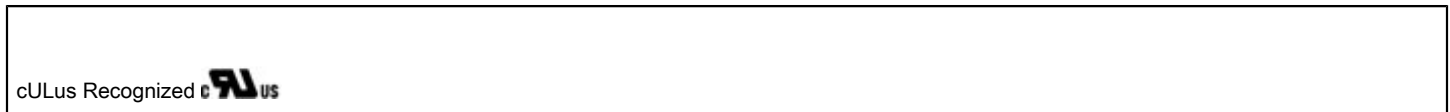
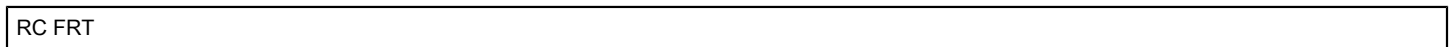
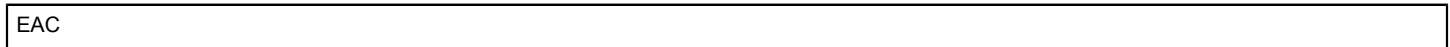

Accessories

Accessories

Bridge

Continuous plug-in bridge - FBST 500-PLC RD - 2966786



Continuous plug-in bridge, Length: 500 mm, Color: red

Continuous plug-in bridge - FBST 500-PLC BU - 2966692



Continuous plug-in bridge, Length: 500 mm, Color: blue

Relay Module - PLC-RPT-120UC/21HC - 2900296

Accessories

Continuous plug-in bridge - FBST 500-PLC GY - 2966838



Continuous plug-in bridge, Length: 500 mm, Color: gray

Single plug-in bridge - FBST 6-PLC RD - 2966236



Single plug-in bridge, Length: 6 mm, Number of positions: 2, Color: red

Single plug-in bridge - FBST 6-PLC BU - 2966812



Single plug-in bridge, Length: 6 mm, Number of positions: 2, Color: blue

Single plug-in bridge - FBST 6-PLC GY - 2966825



Single plug-in bridge, Length: 6 mm, Number of positions: 2, Color: gray

Single plug-in bridge - FBST 8-PLC GY - 2967688



Single plug-in bridge, Length: 8 mm, Number of positions: 2, Color: gray

Relay Module - PLC-RPT-120UC/21HC - 2900296

Accessories

Single plug-in bridge - FBST 14-PLC BK - 2967691



Single plug-in bridge, Length: 14 mm, Number of positions: 2, Color: black

DIN rail

DIN rail, unperforated - NS 35/ 7,5 V2A UNPERF 2000MM - 0801377



DIN rail, unperforated, Width: 35 mm, Height: 7.5 mm, Length: 2000 mm, Color: silver

DIN rail perforated - NS 35/ 7,5 PERF 2000MM - 0801733



DIN rail, material: steel galvanized and passivated with a thick layer, perforated, height 7.5 mm, width 35 mm, length: 2000 mm

DIN rail, unperforated - NS 35/ 7,5 CU UNPERF 2000MM - 0801762



DIN rail, material: Copper, unperforated, height 7.5 mm, width 35 mm, length: 2 m

DIN rail, unperforated - NS 35/15 UNPERF 2000MM - 1201714



DIN rail, material: Steel, unperforated, height 15 mm, width 35 mm, length: 2 m

Relay Module - PLC-RPT-120UC/21HC - 2900296

Accessories

DIN rail, unperforated - NS 35/15 CU UNPERF 2000MM - 1201895



DIN rail, material: Copper, unperforated, 1.5 mm thick, height 15 mm, width 35 mm, length: 2 m

DIN rail, unperforated - NS 35/15-2,3 UNPERF 2000MM - 1201798



DIN rail, material: Steel, unperforated, 2.3 mm thick, height 15 mm, width 35 mm, length: 2 m

DIN rail, unperforated - NS 35/15 AL UNPERF 2000MM - 1201756



DIN rail, deep drawn, high profile, unperforated, 1.5 mm thick, material: aluminum, height 15 mm, width 35 mm, length 2000 mm

DIN rail perforated - NS 35/15 PERF 2000MM - 1201730



DIN rail, material: steel galvanized and passivated with a thick layer, perforated, height 15 mm, width 35 mm, length: 2000 mm

DIN rail, unperforated - NS 35/ 7,5 UNPERF 2000MM - 0801681



DIN rail, material: Steel, unperforated, height 7.5 mm, width 35 mm, length: 2 m

Labeled terminal marker

Relay Module - PLC-RPT-120UC/21HC - 2900296

Accessories

Zack marker strip - ZB10,LGS:FORTL.ZAHLEN - 1053014



Zack marker strip, Strip, white, labeled, can be labeled with: Plotter, Printed horizontally: Consecutive numbers 1 - 10, 11 - 20, etc. up to 991 - 1000, Mounting type: Snap into tall marker groove, for terminal block width: 10.2 mm, Lettering field: 10.15 x 10.5 mm

Partition plate

Separating plate - PLC-ATP BK - 2966841



Separating plate, 2 mm thick, required at the start and end of a PLC terminal strip. Furthermore, it is used for: visual separation of groups, safe isolation of different voltages of neighboring PLC relays in acc. with DIN VDE 0106-101, isolation

Power module

Power terminal block - PLC-ESK GY - 2966508



Power terminal block, for the input of up to four potentials, for mounting on NS 35/7.5

Screwdriver tools

Screwdriver - SZF 1-0,6X3,5 - 1204517



Actuation tool, for ST terminal blocks, also suitable for use as a bladed screwdriver, size: 0.6 x 3.5 x 100 mm, 2-component grip, with non-slip grip

Terminal marking

Relay Module - PLC-RPT-120UC/21HC - 2900296

Accessories

Zack marker strip - ZB10/WH-100:UNBEDRUCKT - 5060883



Zack marker strip, Strip, white, unlabeled, can be labeled with: Plotter, Mounting type: Snap into tall marker groove, for terminal block width: 10.2 mm, Lettering field: 10.15 x 10.5 mm

Zack marker strip - ZB 10:UNBEDRUCKT - 1053001



Zack marker strip, Strip, white, unlabeled, can be labeled with: Plotter, Mounting type: Snap into tall marker groove, for terminal block width: 10.2 mm, Lettering field: 10.5 x 10.15 mm

Spare parts

Relay socket - PLC-BPT-120UC/21HC - 2900258



14 mm PLC basic terminal block for high continuous currents with push-in connection, without relay or solid-state relay, for mounting on DIN rail NS 35/7,5, 1 PDT, input voltage 120 V AC/DC

Single relay - REL-MR-110DC/21HC - 2961338



Plug-in miniature power relay, with power contact for high continuous currents, 1 PDT, input voltage 110 V DC

Drawings

Relay Module - PLC-RPT-120UC/21HC - 2900296

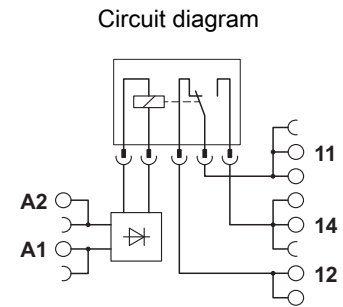
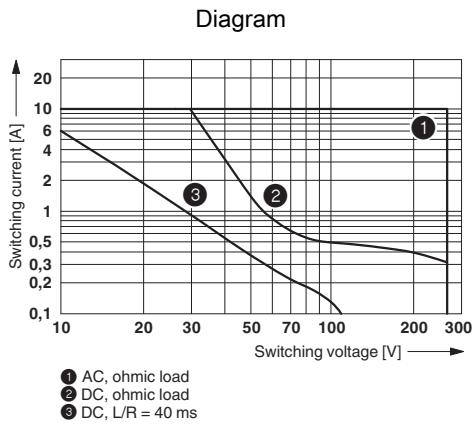

Interrupting rating

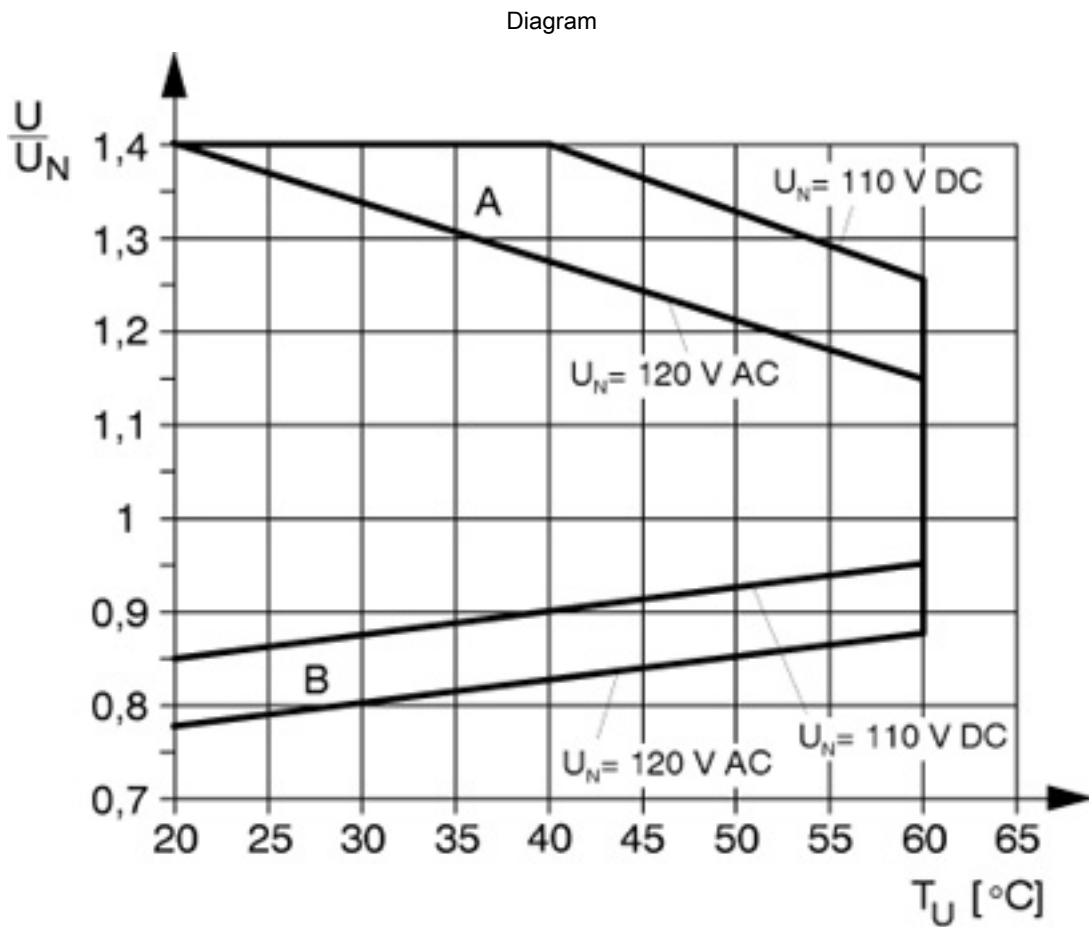

Curve A

Maximum permissible continuous voltage U_{max} with limiting continuous current on the contact side (see relevant technical data)

Relay Module - PLC-RPT-120UC/21HC - 2900296

Curve B

Minimum permissible operate voltage U_{op} after pre-excitation (see relevant technical data)

Phoenix Contact 2016 © - all rights reserved
<http://www.phoenixcontact.com>

Mouser Electronics

Authorized Distributor

Click to View Pricing, Inventory, Delivery & Lifecycle Information:

[Phoenix Contact:](#)

[2900296](#)