

CD4514B, CD4515B Types

CMOS 4-Bit Latch/4-to-16 Line Decoders

High-Voltage Types (20-Volt Rating)
CD4514B Output "High" on Select
CD4515B Output "Low" on Select

■ CD4514B and -CD4515B consist of a 4-bit strobed latch and a 4-to-16-line decoder. The latches hold the last input data presented prior to the strobe transition from 1 to 0. Inhibit control allows all outputs to be placed at 0 (CD4514B) or 1 (CD4515B) regardless of the state of the data or strobe inputs.

The decode truth table indicates all combinations of data inputs and appropriate selected outputs.

These devices are similar to industry types MC14514 and MC14515.

The CD4514B and CD4515B types are supplied in 16-lead hermetic dual-in-line ceramic packages (F3A suffix), 16-lead dual-in-line plastic packages (E suffix), and 16-lead small-outline packages (M and M96 suffixes).

Features:

- Strobed input latch
- Inhibit control
- 100% tested for quiescent current at 20 V
- Maximum input current of 1 μ A at 18 V over full package-temperature range; 100 nA at 18 V and 25°C
- Noise margin (over full package temperature range):
 - 1 V at $V_{DD} = 5$ V
 - 2 V at $V_{DD} = 10$ V
 - 2.5 V at $V_{DD} = 15$ V
- 5-V, 10-V, and 15-V parametric ratings
- Standardized, symmetrical output characteristics.
- Meets all requirements of JEDEC Tentative Standard No. 13B; "Standard Specifications for Description of 'B' Series CMOS Devices"

Applications:

- Digital multiplexing
- Address decoding
- Hexadecimal/BCD decoding
- Program-counter decoding
- Control decoder

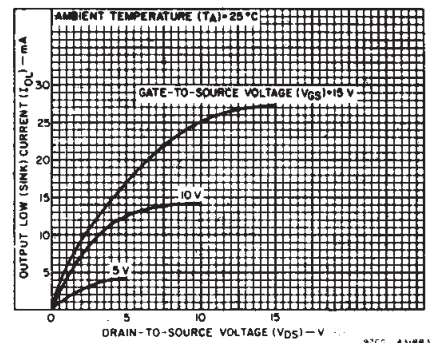
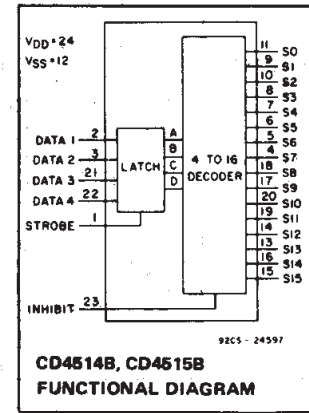

Fig. 1 – Typical output low (sink) current characteristics.

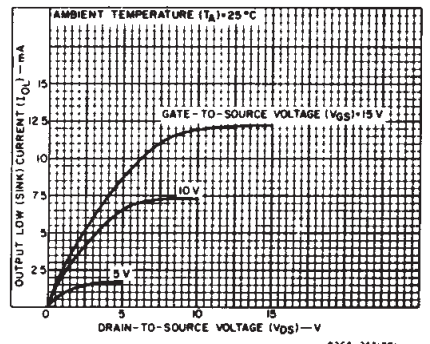

Fig. 2 – Minimum output low (sink) current characteristics.

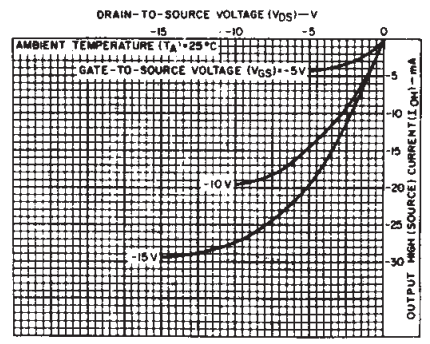

Fig. 3 – Typical output high (source) current characteristics.

MAXIMUM RATINGS, Absolute-Maximum Values:

DC SUPPLY-VOLTAGE RANGE, (V_{DD})	-0.5V to +20V
Voltages referenced to V_{SS} Terminal	
INPUT VOLTAGE RANGE, ALL INPUTS	-0.5V to $V_{DD} + 0.5V$
DC INPUT CURRENT, ANY ONE INPUT	± 10 mA
POWER DISSIPATION PER PACKAGE (P_D):	
For $T_A = -55^\circ\text{C}$ to $+100^\circ\text{C}$	500 mW
For $T_A = +100^\circ\text{C}$ to $+125^\circ\text{C}$	Derate Linearly at 12 mW/ $^\circ\text{C}$ to 200 mW
DEVICE DISSIPATION PER OUTPUT TRANSISTOR	
FOR $T_A =$ FULL PACKAGE-TEMPERATURE RANGE (All Package Types)	100 mW
OPERATING-TEMPERATURE RANGE (T_A)	-55°C to $+125^\circ\text{C}$
STORAGE TEMPERATURE RANGE (T_{stg})	-65°C to $+150^\circ\text{C}$
LEAD TEMPERATURE (DURING SOLDERING):	
At distance 1/16 \pm 1/32 inch (1.59 \pm 0.79 mm) from case for 10s max	$+265^\circ\text{C}$

RECOMMENDED OPERATING CONDITIONS at $T_A = 25^\circ\text{C}$, Except as Noted.
For maximum reliability, nominal operating conditions should be selected so that operation is always within the following ranges:

CHARACTERISTIC	V_{DD} (V)	LIMITS		UNITS
		Min.	Max.	
Supply-Voltage Range (For $T_A =$ Full Package-Temperature Range)		3	18	V
Data Setup Time, t_S	5 10 15	150 70 40	— — —	ns
Strobe Pulse Width, t_W	5 10 15	250 100 75	— — —	ns

3
COMMERCIAL CMOS
HIGH VOLTAGE ICs

CD4514B, CD4515B Types

STATIC ELECTRICAL CHARACTERISTICS

CHARACTERISTIC	CONDITIONS			LIMITS AT INDICATED TEMPERATURES (°C)							UNITS
	V _O (V)	V _{IN} (V)	V _{DD} (V)	-55	-40	+85	+125	+25			
								Min.	Typ.	Max.	
Quiescent Device Current, I _{DD} Max.	-	0.5	5	5	5	150	150	-	0.04	5	μA
	-	0.10	10	10	10	300	300	-	0.04	10	
	-	0.15	15	20	20	600	600	-	0.04	20	
	-	0.20	20	100	100	3000	3000	-	0.08	100	
Output Low (Sink) Current I _{OL} Min.	0.4	0.5	5	0.64	0.61	0.42	0.36	0.51	1	-	mA
	0.5	0.10	10	1.6	1.5	1.1	0.9	1.3	2.6	-	
	1.5	0.15	15	4.2	4	2.8	2.4	3.4	6.8	-	
Output High (Source) Current, I _{OH} Min.	4.6	0.5	5	-0.64	-0.61	-0.42	-0.36	-0.51	-1	-	mA
	2.5	0.5	5	-2	-1.8	-1.3	-1.15	-1.6	-3.2	-	
	9.5	0.10	10	-1.6	-1.5	-1.1	-0.9	-1.3	-2.6	-	
	13.5	0.15	15	-4.2	-4	-2.8	-2.4	-3.4	-6.8	-	
Output Voltage: Low-Level, V _{OL} Max.	-	0.5	5	0.05				-	0	0.05	V
	-	0.10	10	0.05				-	0	0.05	
	-	0.15	15	0.05				-	0	0.05	
Output Voltage: High-Level, V _{OH} Min.	-	0.5	5	4.95				4.95	5	-	V
	-	0.10	10	9.95				9.95	10	-	
	-	0.15	15	14.95				14.95	15	-	
Input Low Voltage, V _{IL} Max.	0.5, 4.5	-	5	1.5				-	-	1.5	V
	1, 9	-	10	3				-	-	3	
	1.5, 13.5	-	15	4				-	-	4	
Input High Voltage, V _{IH} Min.	0.5, 4.5	-	5	3.5				3.5	-	-	V
	1, 9	-	10	7				7	-	-	
	1.5, 13.5	-	15	11				11	-	-	
Input Current I _{IN} Max.	-	0.18	18	±0.1	±0.1	±1	±1	-	±10 ⁻⁵	±0.1	μA

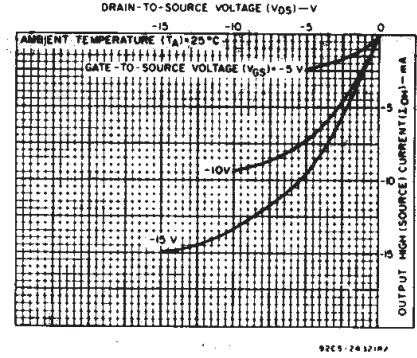

Fig. 4 - Minimum output high (source) current characteristics.

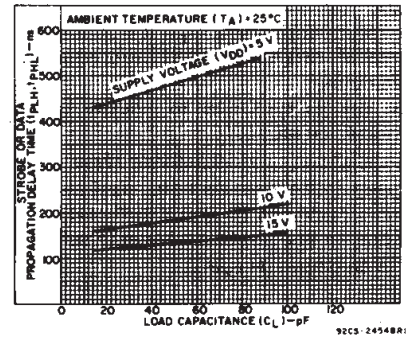

Fig. 5 - Typical strobe or data propagation delay time vs. load capacitance.

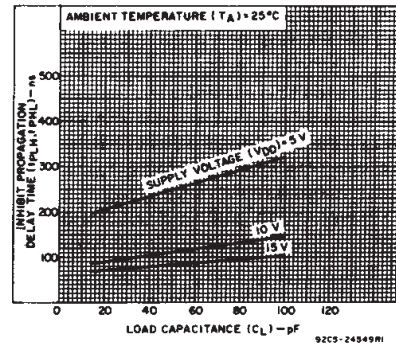

Fig. 6 - Typical inhibit propagation delay time vs. load capacitance.

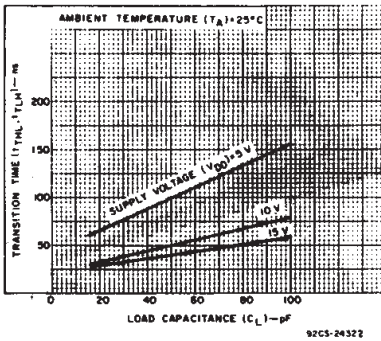

Fig. 7 - Typical low-to-high transition time vs. load capacitance.

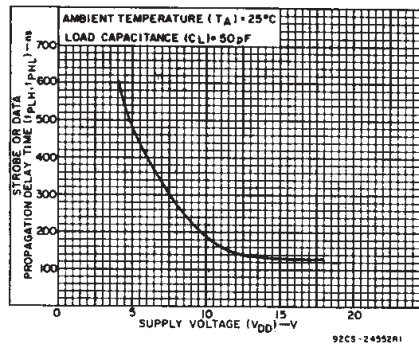

Fig. 8 - Typical strobe or data propagation delay time vs. supply voltage.

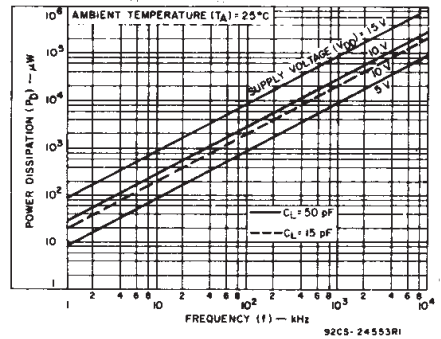

Fig. 9 - Typical power dissipation vs. frequency.

CD4514B, CD4515B Types

DYNAMIC ELECTRICAL CHARACTERISTICS at $T_A = 25^\circ\text{C}$; Input $t_r, t_f = 20\text{ ns}$, $C_L = 50\text{ pF}$, $R_L = 200\text{ K}\Omega$

CHARACTERISTIC	TEST CONDITIONS	LIMITS			UNITS
		VDD V	Typ.	Max.	
Propagation Delay Time: t_{PHL} , t_{PLH} Strobe or Data		5	485	970	ns
		10	185	370	
		15	135	270	
Inhibit		5	250	500	ns
		10	110	220	
		15	85	170	
Transition Time, t_{TLH} , t_{THL}		5	100	200	ns
		10	50	100	
		15	40	80	
Minimum Strobe Pulse Width, t_W		5	125	250	ns
		10	50	100	
		15	40	75	
Minimum Data Setup Time, t_S		5	75	150	ns
		10	35	70	
		15	20	40	
Input Capacitance, C_{IN}	Any Input	—	5	7.5	pF

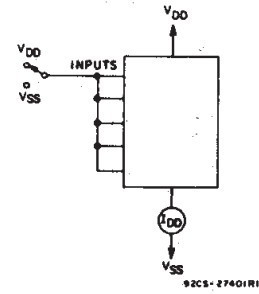

Fig. 10 — Quiescent device current test circuit.

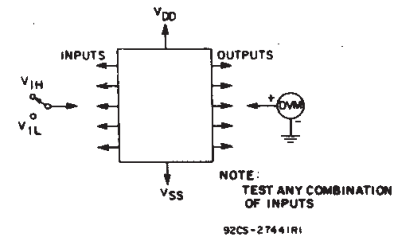

Fig. 11 — Input voltage test circuit.

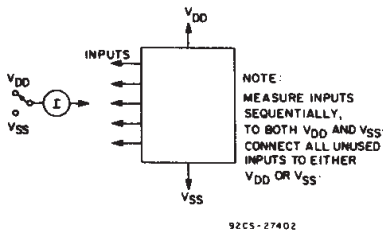

Fig. 12 — Input current test circuit.

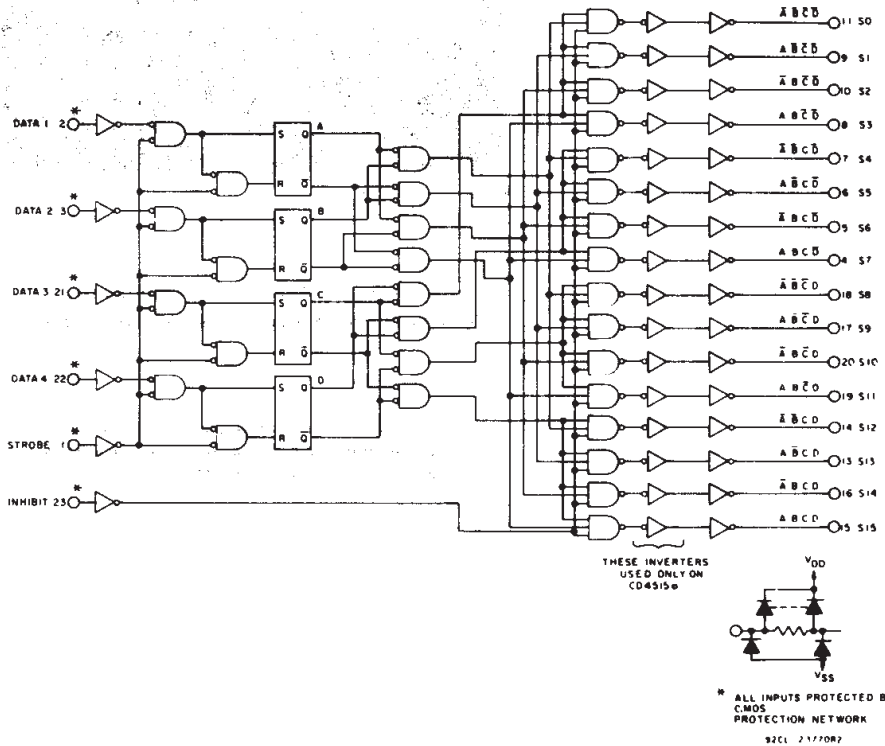

Fig. 13 — Logic diagram for CD4514B and CD4515B.

3
COMMERCIAL CMOS
HIGH VOLTAGE ICs

CD4514B, CD4515B Types

DECODE TRUTH TABLE (Strobe = 1)

INHIBIT	DECODER INPUTS				SELECTED OUTPUT	
	D	C	B	A	CD4514B = Logic 1 (High)	CD4515B = Logic 0 (Low)
0	0	0	0	0	S0	
0	0	0	0	1	S1	
0	0	0	1	0	S2	
0	0	0	1	1	S3	
0	0	1	0	0	S4	
0	0	1	0	1	S5	
0	0	1	1	0	S6	
0	0	1	1	1	S7	
0	1	0	0	0	S8	
0	1	0	0	1	S9	
0	1	0	1	0	S10	
0	1	0	1	1	S11	
0	1	1	0	0	S12	
0	1	1	0	1	S13	
0	1	1	1	0	S14	
0	1	1	1	1	S15	
1	X	X	X	X	All Outputs = 0, CD4514B	All Outputs = 1, CD4515B

X = Don't Care Logic 1 = high Logic 0 = low

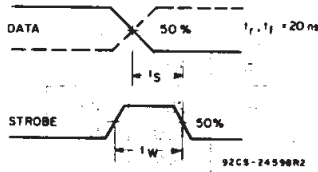
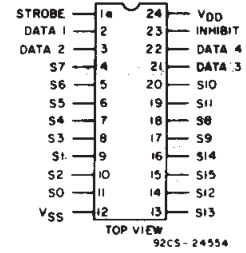
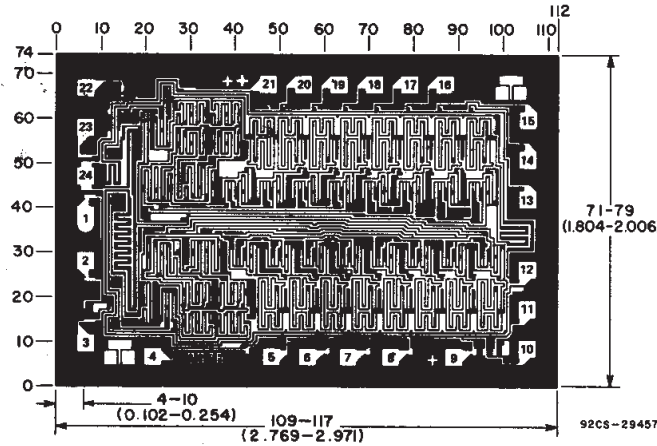

Fig. 14 - Waveforms for setup time and strobe pulse width.



CD4514B
CD4515B

TERMINAL ASSIGNMENT



Dimensions and Pad Layout for CD4515B Chip
(Dimensions and pad layout for the CD4514B are identical)

Dimensions in parentheses are in millimeters and are derived from the basic inch dimensions as indicated. Grid graduations are in mils (10^{-3} inch).

PACKAGING INFORMATION

Orderable Device	Status (1)	Package Type	Package Drawing	Pins	Package Qty	Eco Plan (2)	Lead/Ball Finish (6)	MSL Peak Temp (3)	Op Temp (°C)	Device Marking (4/5)	Samples
7703201JA	ACTIVE	CDIP	J	24	1	TBD	Call TI	N / A for Pkg Type	-55 to 125	7703201JA CD4515BF3A	Samples
CD4514BF	ACTIVE	CDIP	J	24	1	TBD	Call TI	N / A for Pkg Type	-55 to 125	CD4514BF	Samples
CD4514BF3A	ACTIVE	CDIP	J	24	1	TBD	Call TI	N / A for Pkg Type	-55 to 125	CD4514BF3A	Samples
CD4514BM	ACTIVE	SOIC	DW	24	25	Green (RoHS & no Sb/Br)	NIPDAU	Level-1-260C-UNLIM	-55 to 125	CD4514BM	Samples
CD4514BM96	ACTIVE	SOIC	DW	24	2000	Green (RoHS & no Sb/Br)	NIPDAU SN	Level-1-260C-UNLIM	-55 to 125	CD4514BM	Samples
CD4514BM96G4	ACTIVE	SOIC	DW	24	2000	Green (RoHS & no Sb/Br)	NIPDAU	Level-1-260C-UNLIM	-55 to 125	CD4514BM	Samples
CD4515BF3A	ACTIVE	CDIP	J	24	1	TBD	Call TI	N / A for Pkg Type	-55 to 125	7703201JA CD4515BF3A	Samples
CD4515BM	ACTIVE	SOIC	DW	24	25	Green (RoHS & no Sb/Br)	NIPDAU	Level-1-260C-UNLIM	-55 to 125	CD4515BM	Samples
CD4515BM96	ACTIVE	SOIC	DW	24	2000	Green (RoHS & no Sb/Br)	NIPDAU	Level-1-260C-UNLIM	-55 to 125	CD4515BM	Samples
CD4515BME4	ACTIVE	SOIC	DW	24	25	Green (RoHS & no Sb/Br)	NIPDAU	Level-1-260C-UNLIM	-55 to 125	CD4515BM	Samples

(1) The marketing status values are defined as follows:

ACTIVE: Product device recommended for new designs.

LIFEBUY: TI has announced that the device will be discontinued, and a lifetime-buy period is in effect.

NRND: Not recommended for new designs. Device is in production to support existing customers, but TI does not recommend using this part in a new design.

PREVIEW: Device has been announced but is not in production. Samples may or may not be available.

OBSOLETE: TI has discontinued the production of the device.

(2) **RoHS:** TI defines "RoHS" to mean semiconductor products that are compliant with the current EU RoHS requirements for all 10 RoHS substances, including the requirement that RoHS substance do not exceed 0.1% by weight in homogeneous materials. Where designed to be soldered at high temperatures, "RoHS" products are suitable for use in specified lead-free processes. TI may reference these types of products as "Pb-Free".

RoHS Exempt: TI defines "RoHS Exempt" to mean products that contain lead but are compliant with EU RoHS pursuant to a specific EU RoHS exemption.

Green: TI defines "Green" to mean the content of Chlorine (Cl) and Bromine (Br) based flame retardants meet JS709B low halogen requirements of <=1000ppm threshold. Antimony trioxide based flame retardants must also meet the <=1000ppm threshold requirement.

(3) MSL, Peak Temp. - The Moisture Sensitivity Level rating according to the JEDEC industry standard classifications, and peak solder temperature.

(4) There may be additional marking, which relates to the logo, the lot trace code information, or the environmental category on the device.

(5) Multiple Device Markings will be inside parentheses. Only one Device Marking contained in parentheses and separated by a "~" will appear on a device. If a line is indented then it is a continuation of the previous line and the two combined represent the entire Device Marking for that device.

(6) Lead/Ball Finish - Orderable Devices may have multiple material finish options. Finish options are separated by a vertical ruled line. Lead/Ball Finish values may wrap to two lines if the finish value exceeds the maximum column width.

Important Information and Disclaimer:The information provided on this page represents TI's knowledge and belief as of the date that it is provided. TI bases its knowledge and belief on information provided by third parties, and makes no representation or warranty as to the accuracy of such information. Efforts are underway to better integrate information from third parties. TI has taken and continues to take reasonable steps to provide representative and accurate information but may not have conducted destructive testing or chemical analysis on incoming materials and chemicals. TI and TI suppliers consider certain information to be proprietary, and thus CAS numbers and other limited information may not be available for release.

In no event shall TI's liability arising out of such information exceed the total purchase price of the TI part(s) at issue in this document sold by TI to Customer on an annual basis.

OTHER QUALIFIED VERSIONS OF CD4514B, CD4514B-MIL, CD4515B, CD4515B-MIL :

● Catalog: [CD4514B](#), [CD4515B](#)

● Military: [CD4514B-MIL](#), [CD4515B-MIL](#)

NOTE: Qualified Version Definitions:

- Catalog - TI's standard catalog product
- Military - QML certified for Military and Defense Applications

TAPE AND REEL INFORMATION



QUADRANT ASSIGNMENTS FOR PIN 1 ORIENTATION IN TAPE



*All dimensions are nominal

Device	Package Type	Package Drawing	Pins	SPQ	Reel Diameter (mm)	Reel Width W1 (mm)	A0 (mm)	B0 (mm)	K0 (mm)	P1 (mm)	W (mm)	Pin1 Quadrant
CD4514BM96	SOIC	DW	24	2000	330.0	24.4	10.75	15.7	2.7	12.0	24.0	Q1
CD4514BM96G4	SOIC	DW	24	2000	330.0	24.4	10.75	15.7	2.7	12.0	24.0	Q1
CD4515BM96	SOIC	DW	24	2000	330.0	24.4	10.75	15.7	2.7	12.0	24.0	Q1

TAPE AND REEL BOX DIMENSIONS



*All dimensions are nominal

Device	Package Type	Package Drawing	Pins	SPQ	Length (mm)	Width (mm)	Height (mm)
CD4514BM96	SOIC	DW	24	2000	350.0	350.0	43.0
CD4514BM96G4	SOIC	DW	24	2000	350.0	350.0	43.0
CD4515BM96	SOIC	DW	24	2000	350.0	350.0	43.0

N (R-PDIP-T)**

PLASTIC DUAL-IN-LINE PACKAGE

24 PIN SHOWN

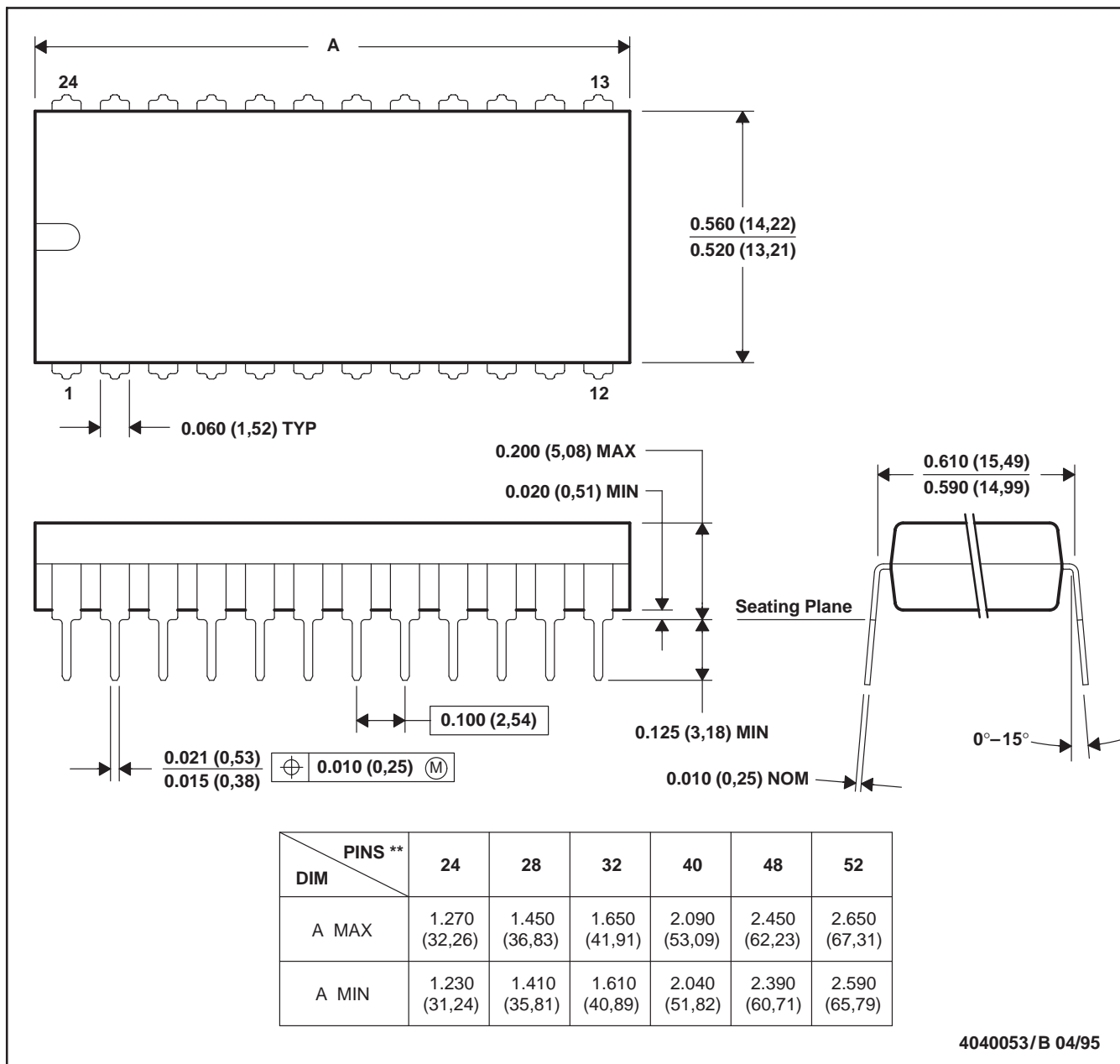

- NOTES: A. All linear dimensions are in inches (millimeters).
 B. This drawing is subject to change without notice.
 C. Falls within JEDEC MS-011
 D. Falls within JEDEC MS-015 (32 pin only)

DW (R-PDSO-G24)

PLASTIC SMALL OUTLINE



- NOTES:
- A. All linear dimensions are in inches (millimeters). Dimensioning and tolerancing per ASME Y14.5M-1994.
 - B. This drawing is subject to change without notice.
 - C. Body dimensions do not include mold flash or protrusion not to exceed 0.006 (0,15).
 - D. Falls within JEDEC MS-013 variation AD.

DW (R-PDSO-G24)

PLASTIC SMALL OUTLINE

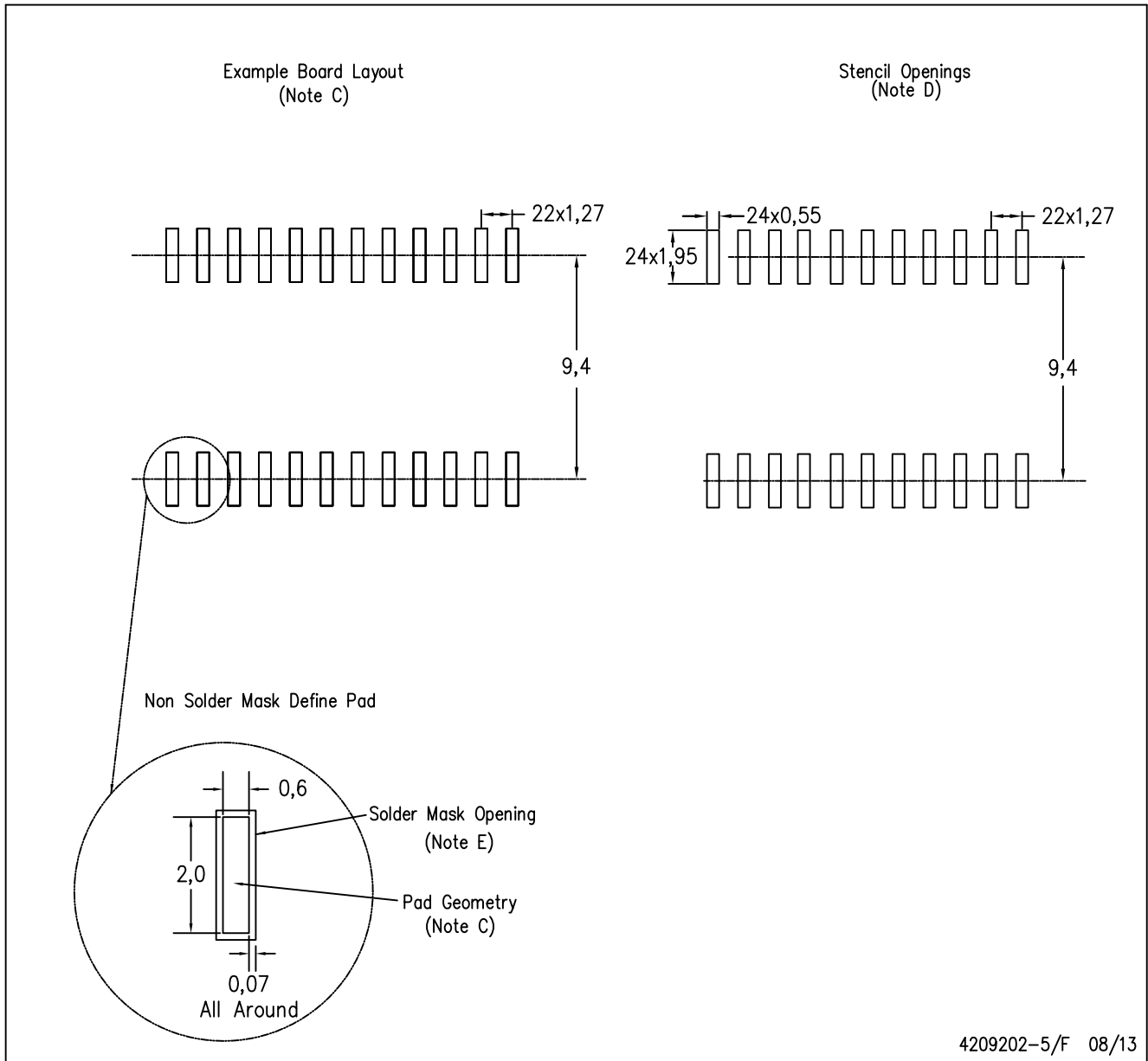

- NOTES:
- A. All linear dimensions are in millimeters.
 - B. This drawing is subject to change without notice.
 - C. Refer to IPC7351 for alternate board design.
 - D. Laser cutting apertures with trapezoidal walls and also rounding corners will offer better paste release. Customers should contact their board assembly site for stencil design recommendations. Refer to IPC-7525
 - E. Customers should contact their board fabrication site for solder mask tolerances between and around signal pads.

J (R-GDIP-T**)

CERAMIC DUAL-IN-LINE PACKAGE

24 PINS SHOWN

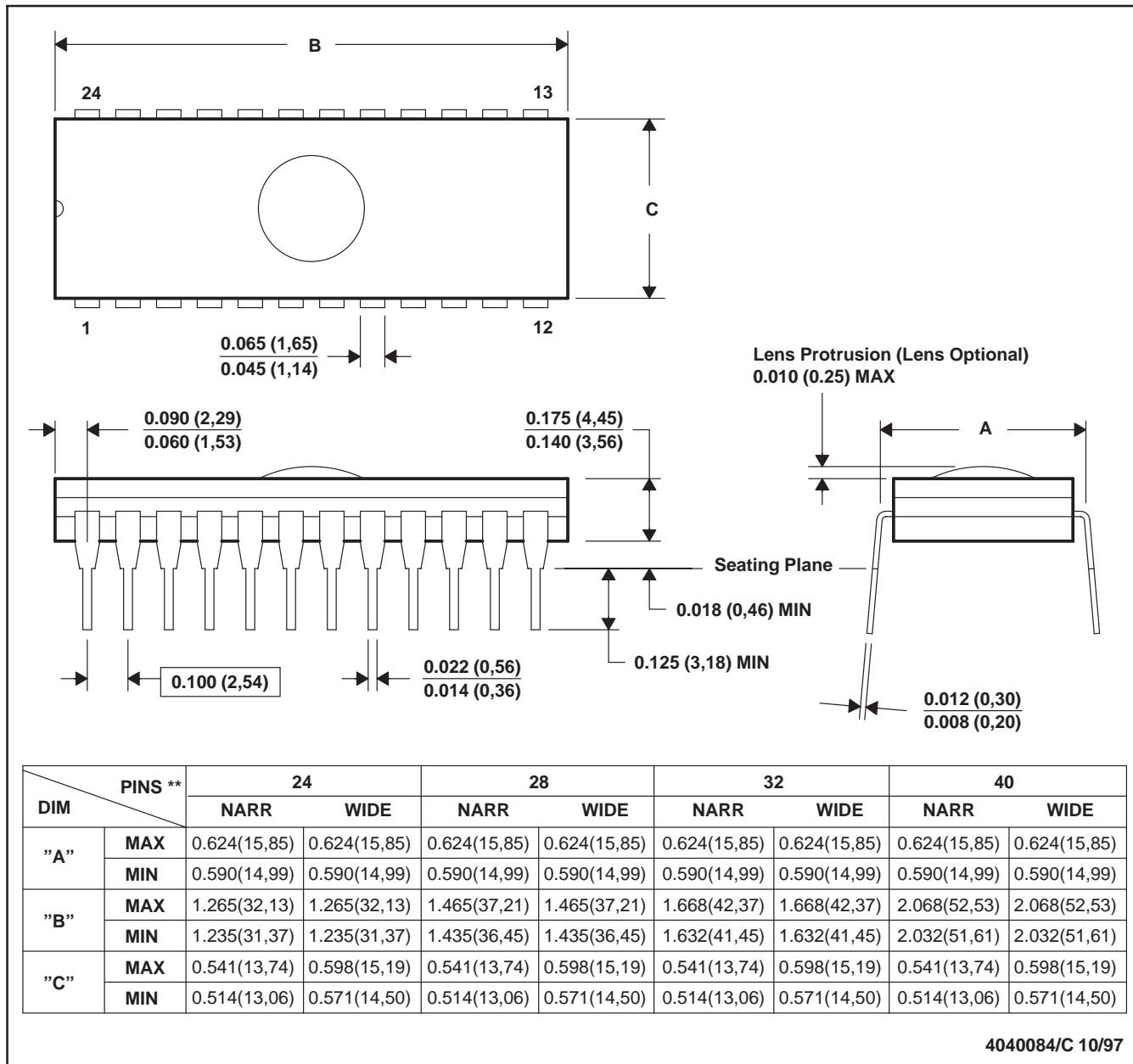

- NOTES: A. All linear dimensions are in inches (millimeters).
 B. This drawing is subject to change without notice.
 C. Window (lens) added to this group of packages (24-, 28-, 32-, 40-pin).
 D. This package can be hermetically sealed with a ceramic lid using glass frit.
 E. Index point is provided on cap for terminal identification.

PW0024A



PACKAGE OUTLINE

TSSOP - 1.2 mm max height

SMALL OUTLINE PACKAGE

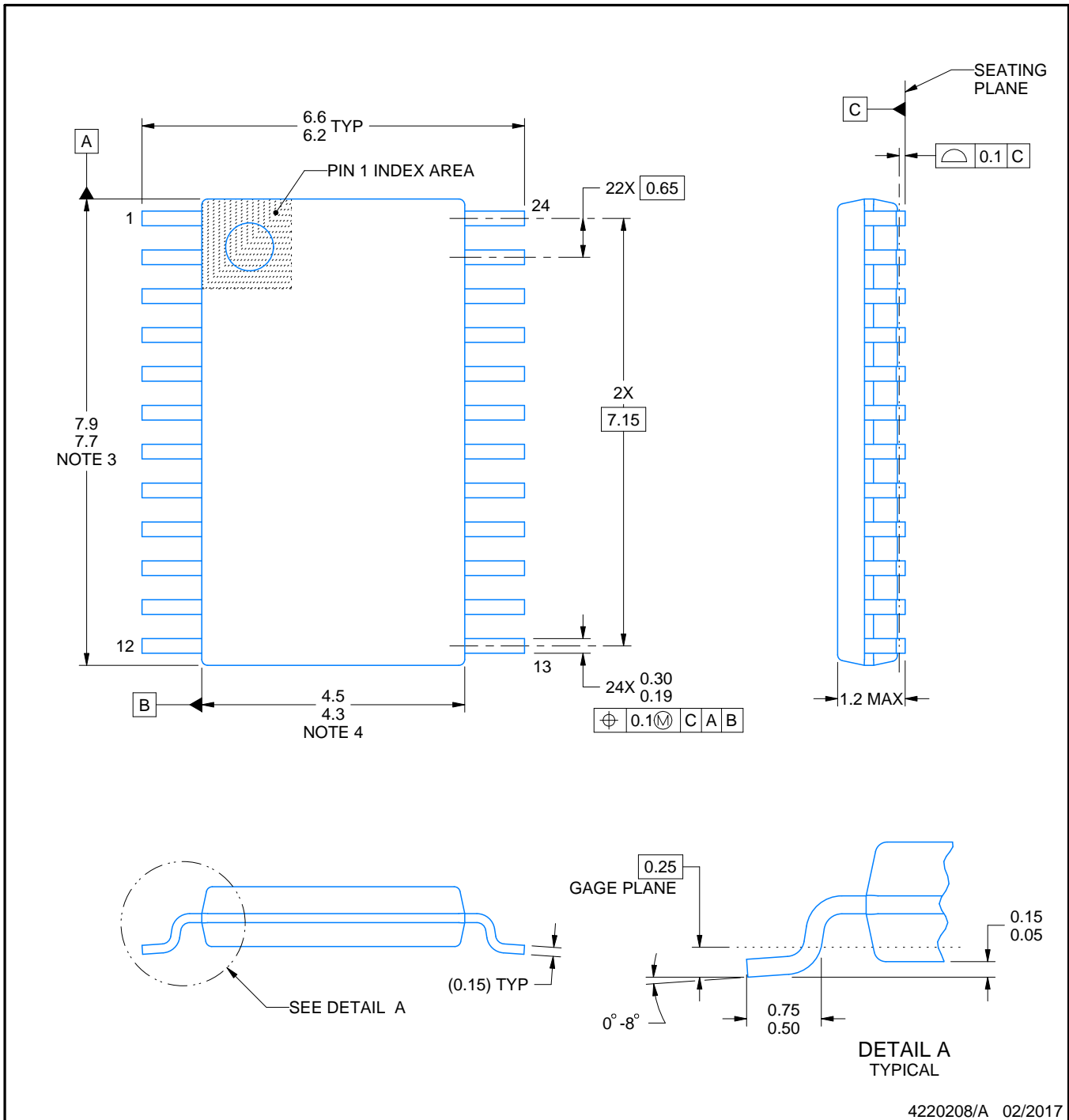

4220208/A 02/2017

NOTES:

1. All linear dimensions are in millimeters. Any dimensions in parenthesis are for reference only. Dimensioning and tolerancing per ASME Y14.5M.
2. This drawing is subject to change without notice.
3. This dimension does not include mold flash, protrusions, or gate burrs. Mold flash, protrusions, or gate burrs shall not exceed 0.15 mm per side.
4. This dimension does not include interlead flash. Interlead flash shall not exceed 0.25 mm per side.
5. Reference JEDEC registration MO-153.

EXAMPLE BOARD LAYOUT

PW0024A

TSSOP - 1.2 mm max height

SMALL OUTLINE PACKAGE



LAND PATTERN EXAMPLE
EXPOSED METAL SHOWN
SCALE: 10X

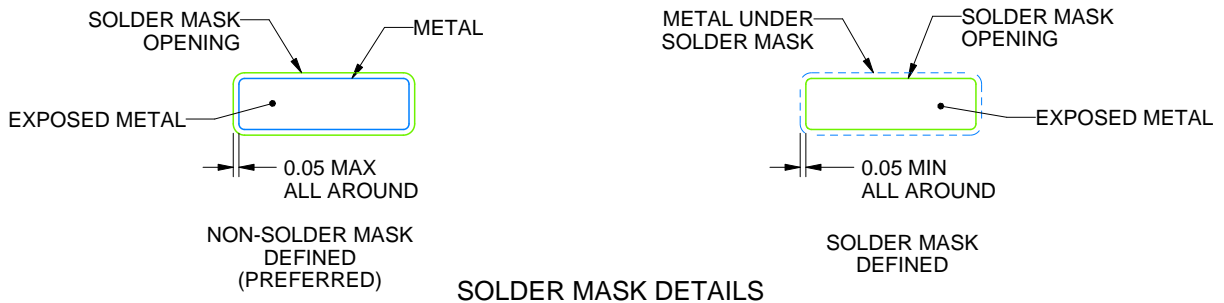

SOLDER MASK DETAILS

4220208/A 02/2017

NOTES: (continued)

- 6. Publication IPC-7351 may have alternate designs.
- 7. Solder mask tolerances between and around signal pads can vary based on board fabrication site.

EXAMPLE STENCIL DESIGN

PW0024A

TSSOP - 1.2 mm max height

SMALL OUTLINE PACKAGE



NOTES: (continued)

8. Laser cutting apertures with trapezoidal walls and rounded corners may offer better paste release. IPC-7525 may have alternate design recommendations.
9. Board assembly site may have different recommendations for stencil design.

MECHANICAL DATA

NS (R-PDSO-G)**

PLASTIC SMALL-OUTLINE PACKAGE

14-PINS SHOWN



- NOTES:
- A. All linear dimensions are in millimeters.
 - B. This drawing is subject to change without notice.
 - C. Body dimensions do not include mold flash or protrusion, not to exceed 0,15.

IMPORTANT NOTICE AND DISCLAIMER

TI PROVIDES TECHNICAL AND RELIABILITY DATA (INCLUDING DATASHEETS), DESIGN RESOURCES (INCLUDING REFERENCE DESIGNS), APPLICATION OR OTHER DESIGN ADVICE, WEB TOOLS, SAFETY INFORMATION, AND OTHER RESOURCES "AS IS" AND WITH ALL FAULTS, AND DISCLAIMS ALL WARRANTIES, EXPRESS AND IMPLIED, INCLUDING WITHOUT LIMITATION ANY IMPLIED WARRANTIES OF MERCHANTABILITY, FITNESS FOR A PARTICULAR PURPOSE OR NON-INFRINGEMENT OF THIRD PARTY INTELLECTUAL PROPERTY RIGHTS.

These resources are intended for skilled developers designing with TI products. You are solely responsible for (1) selecting the appropriate TI products for your application, (2) designing, validating and testing your application, and (3) ensuring your application meets applicable standards, and any other safety, security, or other requirements. These resources are subject to change without notice. TI grants you permission to use these resources only for development of an application that uses the TI products described in the resource. Other reproduction and display of these resources is prohibited. No license is granted to any other TI intellectual property right or to any third party intellectual property right. TI disclaims responsibility for, and you will fully indemnify TI and its representatives against, any claims, damages, costs, losses, and liabilities arising out of your use of these resources.

TI's products are provided subject to TI's Terms of Sale (www.ti.com/legal/termsofsale.html) or other applicable terms available either on ti.com or provided in conjunction with such TI products. TI's provision of these resources does not expand or otherwise alter TI's applicable warranties or warranty disclaimers for TI products.

Mailing Address: Texas Instruments, Post Office Box 655303, Dallas, Texas 75265
Copyright © 2020, Texas Instruments Incorporated