

## EVA-WW

~55° wide beam

### TECHNICAL SPECIFICATIONS:

Dimensions	Ø 35.0 mm
Height	16.4 mm
Fastening	glue
ROHS compliant	yes 

### MATERIAL SPECIFICATIONS:

Component	Type	Material	Colour	Finish
EVA-WW	Single lens	PMMA	clear	



### ORDERING INFORMATION:

Component	Qty in box	MOQ	MPQ	Box weight (kg)
C10909_EVA-WW » Box size: 480 x 280 x 300 mm	540	90	45	6.0

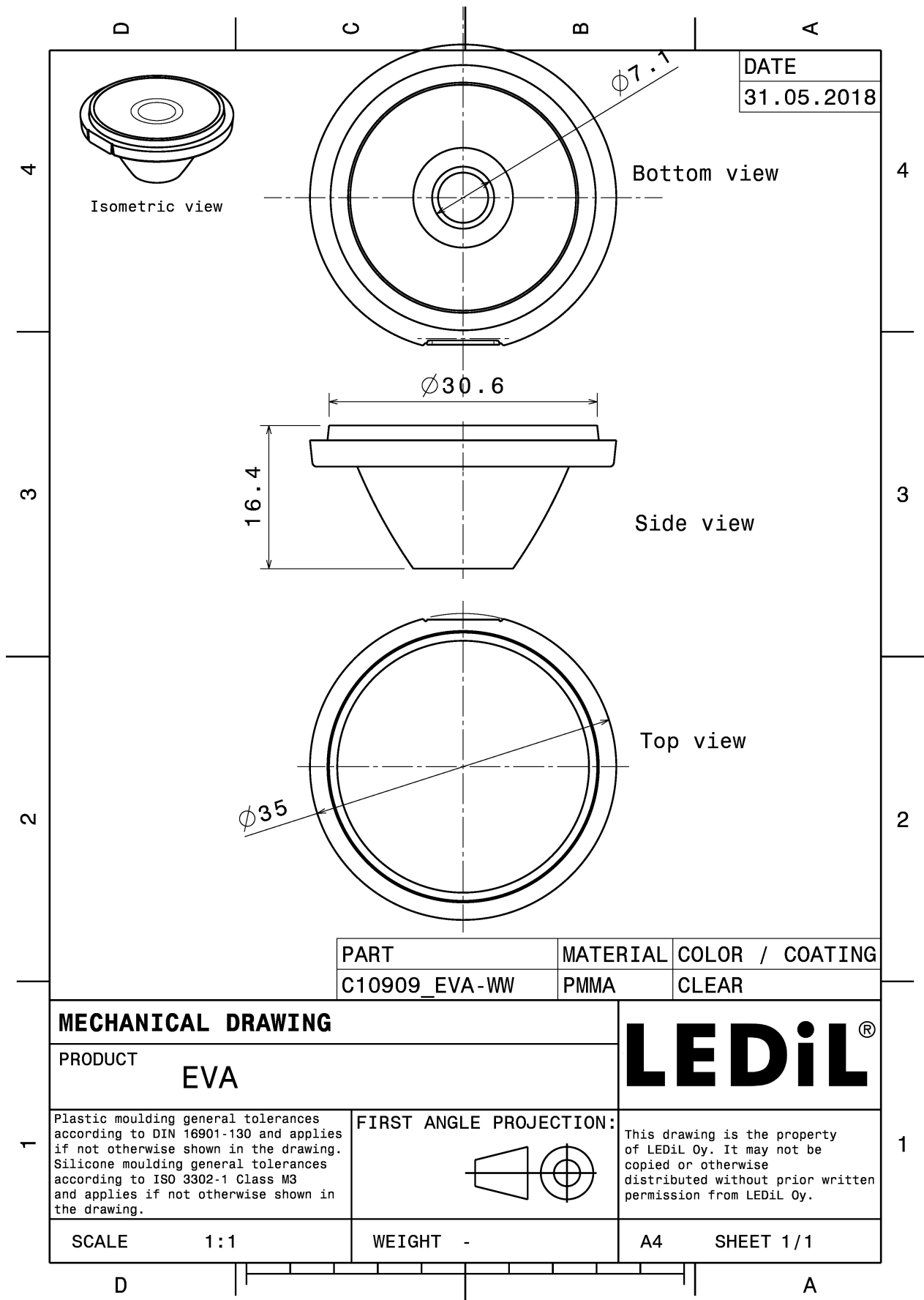

**PHOTOMETRIC DATA (MEASURED):**

## CITIZEN

LED CLU7A2 (LES 4.2mm)  
 FWHM 48.0°  
 Efficiency 81 %  
 Peak intensity 1.1 cd/lm  
 LEDs/each optic 1  
 Light colour White  
 Required components:

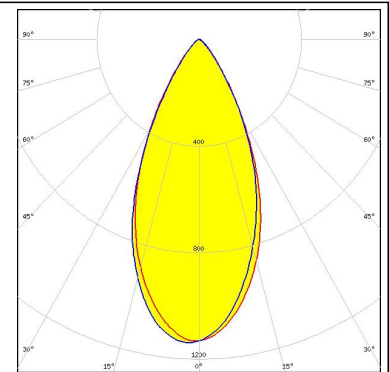
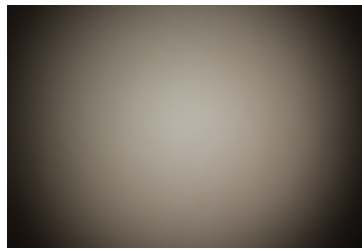

## CREE

LED MC-E  
 FWHM 47.0°  
 Efficiency 90 %  
 Peak intensity 1 cd/lm  
 LEDs/each optic 1  
 Light colour White  
 Required components:

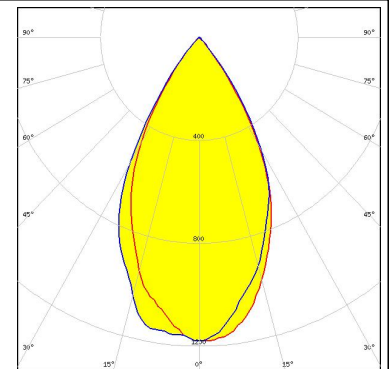
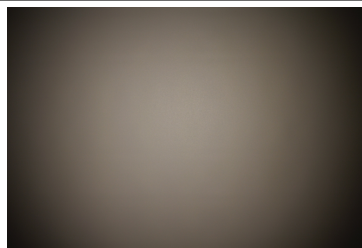

## CREE

LED MHB-A/B  
 FWHM 52.0°  
 Efficiency 76 %  
 Peak intensity 1 cd/lm  
 LEDs/each optic 1  
 Light colour White  
 Required components:

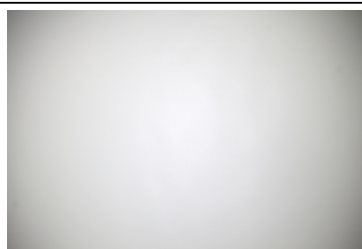

## CREE

LED XHP35 HI  
 FWHM 71.0°  
 Efficiency 75 %  
 Peak intensity 0.6 cd/lm  
 LEDs/each optic 1  
 Light colour White  
 Required components:

**PHOTOMETRIC DATA (MEASURED):**



LED XM-L  
FWHM 64.0°  
Efficiency 77 %  
LEDs/each optic 1  
Light colour White  
Required components:



LED XT-E  
FWHM 47.0°  
Efficiency 76 %  
Peak intensity 1.1 cd/lm  
LEDs/each optic 1  
Light colour White  
Required components:

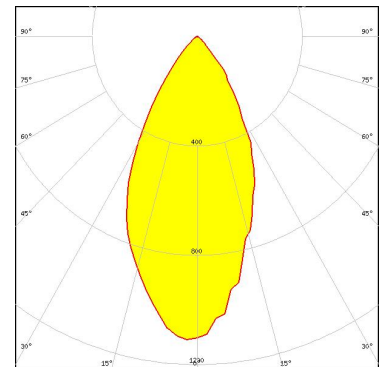

LED LUXEON 5050 Round LES  
FWHM 57.0°  
Efficiency 78 %  
Peak intensity 1 cd/lm  
LEDs/each optic 1  
Light colour White  
Required components:

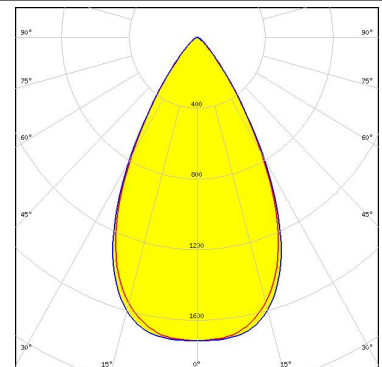
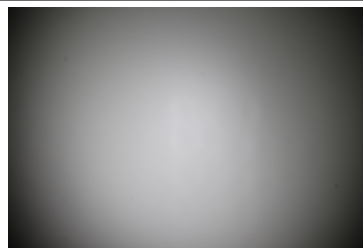

LED LUXEON M/MX  
FWHM 65.0°  
Efficiency 80 %  
LEDs/each optic 1  
Light colour White  
Required components:

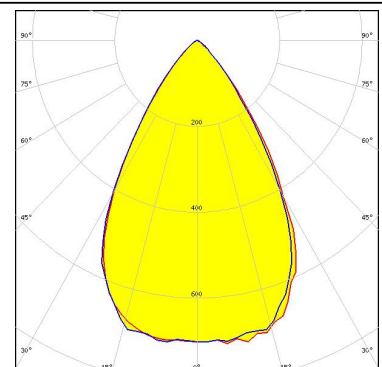

## PHOTOMETRIC DATA (MEASURED):

**OSRAM**  
Opto Semiconductors

LED Duris S8  
FWHM 55.0°  
Efficiency 79 %  
Peak intensity 1 cd/lm  
LEDs/each optic 1  
Light colour White  
Required components:

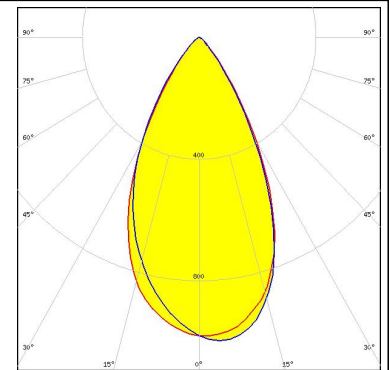

**SEOL**  
SEOUL SEMICONDUCTOR

LED Z8Y15  
FWHM 45.0°  
Efficiency 77 %  
Peak intensity 1.3 cd/lm  
LEDs/each optic 1  
Light colour White  
Required components:

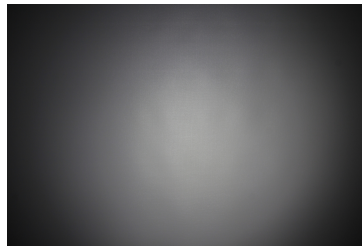

**SEOL**  
SEOUL SEMICONDUCTOR

LED Z8Y19  
FWHM 47.0°  
Efficiency 76 %  
Peak intensity 1.2 cd/lm  
LEDs/each optic 1  
Light colour White  
Required components:

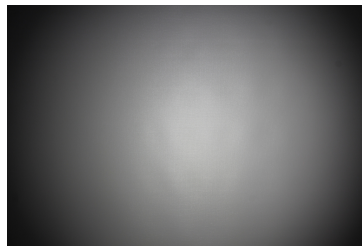

### PHOTOMETRIC DATA (SIMULATED):



LED XM-L HVW  
FWHM 58.0°  
Efficiency %  
LEDs/each optic 1  
Light colour White  
Required components:



LED XP-G2  
FWHM 57.0°  
Efficiency 90 %  
Peak intensity 1.1 cd/lm  
LEDs/each optic 1  
Light colour White  
Required components:

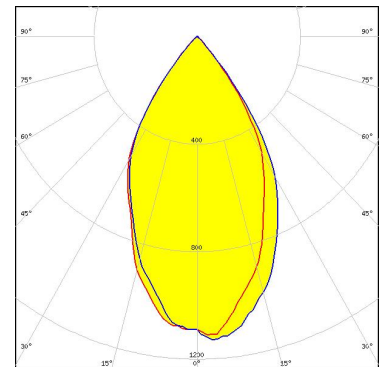

LED LUXEON 5258  
FWHM 50.0°  
Efficiency 93 %  
Peak intensity 1.3 cd/lm  
LEDs/each optic 1  
Light colour White  
Required components:



LED CXM-3  
FWHM 49.0°  
Efficiency 95 %  
Peak intensity 1.4 cd/lm  
LEDs/each optic 1  
Light colour White  
Required components:

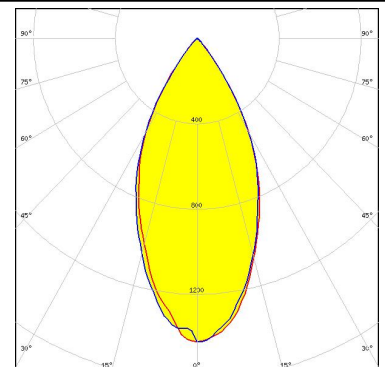

### PHOTOMETRIC DATA (SIMULATED):



LED CXM-4  
FWHM 50.0°  
Efficiency 95 %  
Peak intensity 1.4 cd/lm  
LEDs/each optic 1  
Light colour White  
Required components:

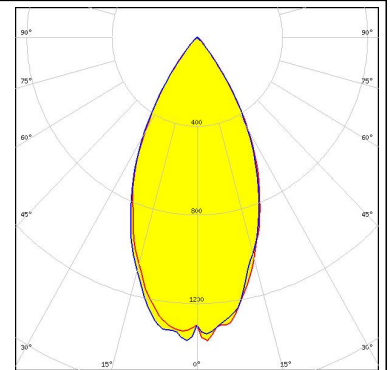

LED OSCONIQ P 7070  
FWHM 56.0°  
Efficiency 93 %  
Peak intensity 1.2 cd/lm  
LEDs/each optic 1  
Light colour White  
Required components:

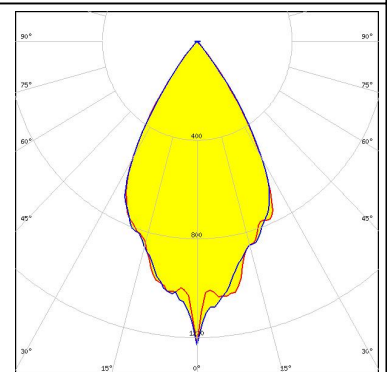

### GENERAL INFORMATION:

NOTE: The typical beam angle will be changed by different color, chip size and chip position tolerance. The typical total beam angle is the full angle measured where the luminous intensity is half of the peak value.

Due to use of high power COB's with this product, special attention to proper thermal design is highly recommended. LEDiL has no liability for direct, indirect or consecutive damages arising from the LEDiL products being used outside of the recommended temperature range.

### MATERIALS:

As part of our continuous research and improvement processes, and to ensure the best possible quality and availability of our products, LEDiL reserves the right to change material grades without notice.

### PRODUCT DATA USER AGREEMENT AND DISCLAIMER:

The measured data in the provided downloadable LEDiL Product Datasheets and Mechanical 2D-Drawings is rounded and provided as reference for planning. LEDiL Oy's optical specifications have been verified by conducting performance testing of the products in accordance with the company's quality system. The reported data are averaged results of multiple measurements with typical variation. LEDiL Oy reserves the right to without prior notification make changes and improvements to its products.

LEDiL Oy assumes neither warranty, nor guarantee nor any other liability of any kind for the contents and correctness of the provided data. The provided data has been generated with highest diligence but the provided data may in reality not represent the complete possible variation range of all intrinsic parameters. Therefore, in certain cases a deviation from the provided data could occur.

LEDiL Oy reserves the right to undertake technical changes of its products without further notification which could lead to changes in the provided data. LEDiL Oy assumes no liability of any kind for the possible deviation from any provided data or any other damage resulting from the usage of the provided data.

The user agrees to this disclaimer and user agreement with the download or usage of the provided files.

#### LEDiL Oy

Joensuunkatu 13  
FI-24240 SALO  
Finland

#### LEDiL Inc.

228 West Page Street  
Suite D  
Sycamore IL 60178  
USA

#### Local sales and technical support

[www.ledil.com/  
where\\_to\\_buy](http://www.ledil.com/where_to_buy)

#### Shipping locations

Salo, Finland  
Hong Kong, China

#### Distribution Partners

[www.ledil.com/  
where\\_to\\_buy](http://www.ledil.com/where_to_buy)



# Mouser Electronics

Authorized Distributor

Click to View Pricing, Inventory, Delivery & Lifecycle Information:

Ledil:

[C10909\\_EVA-WW](#)