

12 A Snubberless™, logic level and standard triacs

Features

- Medium current triac
- Low thermal resistance with clip bonding
- Low thermal resistance insulation ceramic for insulated BTA
- High commutation (4Q) or very high commutation (3Q) capability
- BTA series UL1557 certified (File ref: 81734)
- Packages are RoHS (2002/95/EC) compliant

Applications

ON/OFF or phase angle function in applications such as static relays, light dimmers and appliance motors speed controllers.

The snubberless versions (BTA/BTB...W and T12 series) are especially recommended for use on inductive loads, because of their high commutation performances. The BTA series provides an insulated tab (rated at 2500 V RMS).

Description

Available either in through-hole or surface-mount packages, the **BTA12**, **BTB12** and **T12xx** triac series is suitable for general purpose mains power AC switching.



Order code

See [Ordering information on page 11](#)

Table 1. Device summary

| Symbol | Parameter | T12xx | BTA12 ⁽¹⁾ | BTB12 |
|------------------------|-----------------------------------|----------|----------------------|------------|
| $I_{T(RMS)}$ | RMS on-state current | 12 | 12 | 12 |
| V_{DRM}/V_{RRM} | Repetitive peak off-state voltage | 600/800 | 600/800 | 600/800 |
| I_{GT} (Snubberless) | Triggering gate current | 10/35/50 | 5/10/35/50 | 5/10/35/50 |
| I_{GT} (Standard) | Triggering gate current | - | 35/50 | 35/50 |

1. Insulated

TM: Snubberless is a trademark of STMicroelectronics

1 Characteristics

Table 2. Absolute maximum ratings

| Symbol | Parameter | | | Value | Unit | |
|--------------------|--|------------------------------|---------------------|-------------------------|--------------------------------|------------|
| $I_{T(RMS)}$ | RMS on-state current (full sine wave) | $I^2PAK / D^2PAK / TO-220AB$ | $T_c = 105^\circ C$ | 12 | A | |
| | | TO-220AB Ins. | $T_c = 90^\circ C$ | | | |
| I_{TSM} | Non repetitive surge peak on-state current (full cycle, T_j initial = $25^\circ C$) | $F = 50 Hz$ | $t = 20 ms$ | 120 | A | |
| | | $F = 60 Hz$ | $t = 16.7 ms$ | 126 | | |
| I^2t | I^2t Value for fusing | $t_p = 10 ms$ | | 78 | A^2s | |
| di/dt | Critical rate of rise of on-state current $I_G = 2 \times I_{GT}$, $t_r \leq 100 ns$ | $F = 120 Hz$ | $T_j = 125^\circ C$ | 50 | $A/\mu s$ | |
| V_{DSM}/V_{RSM} | Non repetitive surge peak off-state voltage | $t_p = 10 ms$ | $T_j = 25^\circ C$ | $V_{DRM}/V_{RRM} + 100$ | V | |
| I_{GM} | Peak gate current | $t_p = 20 \mu s$ | $T_j = 125^\circ C$ | 4 | A | |
| $P_{G(AV)}$ | Average gate power dissipation | $T_j = 125^\circ C$ | | 1 | W | |
| T_{stg} T_j | Storage junction temperature range Operating junction temperature range | | | | - 40 to + 150 - 40 to + 125 | $^\circ C$ |

**Table 3. Electrical characteristics ($T_j = 25^\circ C$, unless otherwise specified)
Snubberless and logic level (3 quadrants)**

| Symbol | Test conditions | Quadrant | | T12xx | | | BTA12 / BTB12 | | | | Unit |
|-------------------|---|--------------|------|-------|-------|-------|---------------|-----|-----|------|-----------|
| | | | | T1210 | T1235 | T1250 | TW | SW | CW | BW | |
| $I_{GT}^{(1)}$ | $V_D = 12 V$ $R_L = 30 \Omega$ | I - II - III | MAX. | 10 | 35 | 50 | 5 | 10 | 35 | 50 | mA |
| V_{GT} | | I - II - III | MAX. | 1.3 | | | | | | V | |
| V_{GD} | $V_D = V_{DRM}$ $R_L = 3.3 k\Omega$ $T_j = 125^\circ C$ | I - II - III | MIN. | 0.2 | | | | | | V | |
| $I_H^{(2)}$ | $I_T = 100 mA$ | | MAX. | 15 | 35 | 50 | 10 | 15 | 35 | 50 | mA |
| I_L | $I_G = 1.2 I_{GT}$ | I - III | MAX. | 25 | 50 | 70 | 10 | 25 | 50 | 70 | mA |
| | | II | | 30 | 60 | 80 | 15 | 30 | 60 | 80 | |
| $dV/dt^{(2)}$ | $V_D = 67 \% V_{DRM}$ gate open $T_j = 125^\circ C$ | | MIN. | 40 | 500 | 1000 | 20 | 40 | 500 | 1000 | $V/\mu s$ |
| $(di/dt)_c^{(2)}$ | $(dV/dt)_c = 0.1 V/\mu s$ $T_j = 125^\circ C$ | | MIN. | 6.5 | | | 3.5 | 6.5 | | | A/ms |
| | $(dV/dt)_c = 10 V/\mu s$ $T_j = 125^\circ C$ | | | 2.9 | | | 1 | 2.9 | | | |
| | Without snubber $T_j = 125^\circ C$ | | | | 6.5 | 12 | | | 6.5 | 12 | |

1. Minimum I_{GT} is guaranteed at 5% of I_{GT} max
2. for both polarities of A2 referenced to A1

Table 4. Electrical characteristics ($T_j = 25^\circ\text{C}$, unless otherwise specified) standard (4 quadrants)

| Symbol | Test Conditions | Quadrant | | BTA12 / BTB12 | | Unit |
|-------------------|---|--------------------|------|---------------|-----------|------------------|
| | | | | C | B | |
| $I_{GT}^{(1)}$ | $V_D = 12\text{ V}$ $R_L = 30\ \Omega$ | I - II - III IV | MAX. | 25 50 | 50 100 | mA |
| V_{GT} | | ALL | MAX. | 1.3 | | V |
| V_{GD} | $V_D = V_{DRM}$ $R_L = 3.3\text{ k}\Omega$ $T_j = 125^\circ\text{ C}$ | ALL | MIN. | 0.2 | | V |
| $I_H^{(2)}$ | $I_T = 500\text{ mA}$ | | MAX. | 25 | 50 | mA |
| I_L | $I_G = 1.2\ I_{GT}$ | I - III - IV | MAX. | 40 | 50 | mA |
| | | II | | 80 | 100 | |
| $dV/dt^{(2)}$ | $V_D = 67\% V_{DRM}$ gate open $T_j = 125^\circ\text{ C}$ | | MIN. | 200 | 400 | V/ μs |
| $(dI/dt)_c^{(2)}$ | $(dI/dt)_c = 5.3\text{ A/ms}$ $T_j = 125^\circ\text{ C}$ | | MIN. | 5 | 10 | V/ μs |

1. Minimum I_{GT} is guaranteed at 5% of I_{GT} max.
2. for both polarities of A2 referenced to A1.

Table 5. Static characteristics

| Symbol | Test conditions | | | Value | Unit | |
|------------------------|------------------------|--------------------------|----------------------------|-------|------|---------------|
| $V_T^{(1)}$ | $I_{TM} = 17\text{ A}$ | $t_p = 380\ \mu\text{s}$ | $T_j = 25^\circ\text{ C}$ | MAX. | 1.55 | V |
| $V_{i0}^{(1)}$ | Threshold voltage | | $T_j = 125^\circ\text{ C}$ | MAX. | 0.85 | V |
| $R_d^{(1)}$ | Dynamic resistance | | $T_j = 125^\circ\text{ C}$ | MAX. | 35 | m Ω |
| I_{DRM} I_{RRM} | $V_{DRM} = V_{RRM}$ | | $T_j = 25^\circ\text{ C}$ | MAX. | 5 | μA |
| | | | $T_j = 125^\circ\text{ C}$ | | 1 | mA |

1. for both polarities of A2 referenced to A1

Table 6. Thermal resistance

| Symbol | Parameter | | Value | Unit | |
|---------------|-----------------------|---------------------------|---|------|--------------------|
| $R_{th(j-c)}$ | Junction to case (AC) | | I ² PAK / D ² PAK / TO-220AB | 1.4 | $^\circ\text{C/W}$ |
| | | | TO-220AB insulated | 2.3 | |
| $R_{th(j-a)}$ | Junction to ambient | $S^{(1)} = 1\text{ cm}^2$ | D ² PAK | 45 | $^\circ\text{C/W}$ |
| | | | TO-220AB / I ² PAK TO-220AB insulated | 60 | |

1. Copper surface under tab.

Figure 1. Maximum power dissipation versus RMS on-state current (full cycle)

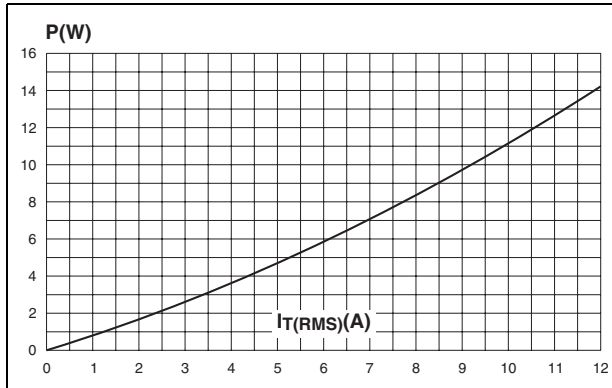

Figure 2. RMS on-state current versus case temperature (full cycle)



Figure 3. RMS on-state current versus ambient temperature (printed circuit board FR4, copper thickness: 35µm) (full cycle)

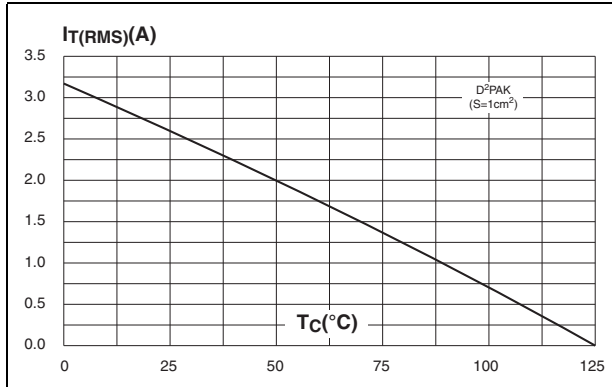

Figure 4. Relative variation of thermal impedance versus pulse duration



Figure 5. On-state characteristics (maximum values)

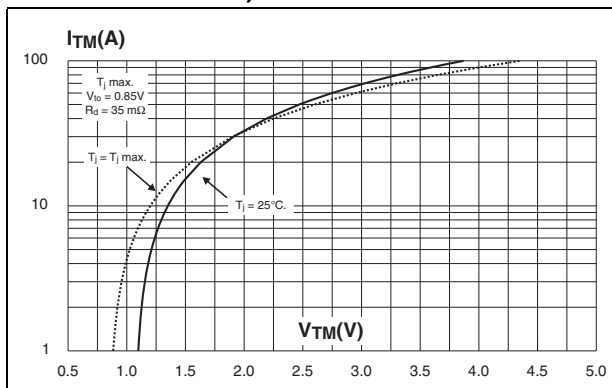

Figure 6. Surge peak on-state current versus number of cycles

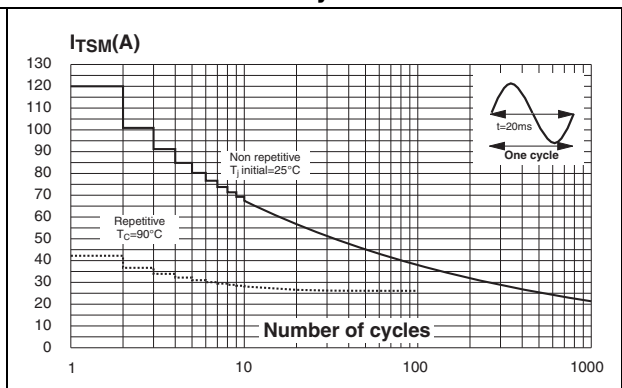

Figure 7. Non-repetitive surge peak on-state current for a sinusoidal pulse with width $t_p < 10$ ms and corresponding value of I^2t

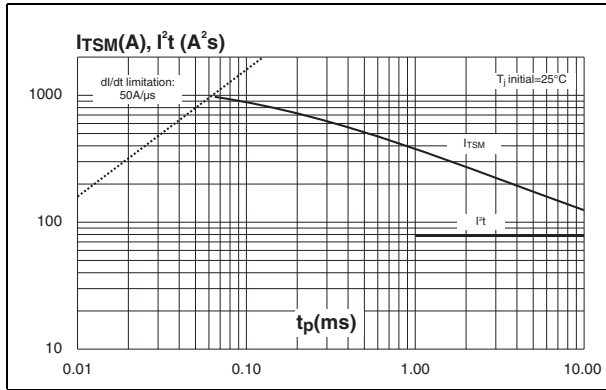

Figure 8. Figure 8: Relative variation of gate trigger current, holding current and latching current versus junction temperature (typical values)

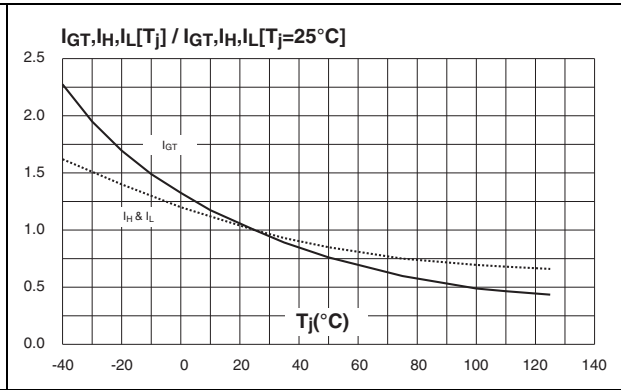

Figure 9. Relative variation of critical rate of decrease of main current versus $(dV/dt)_c$ (typical values) (BW/CW/T1210/T1235)

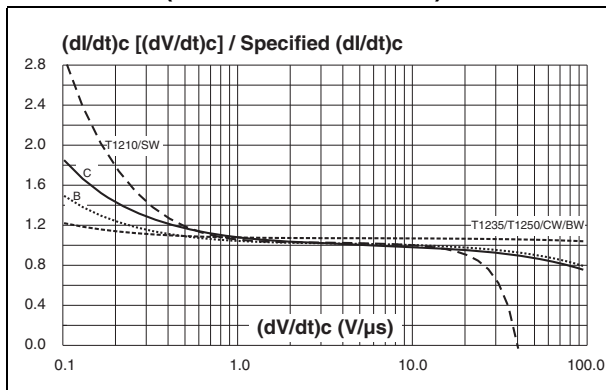

Figure 10. Relative variation of critical rate of decrease of main current versus $(dV/dt)_c$ (typical values) (TW)

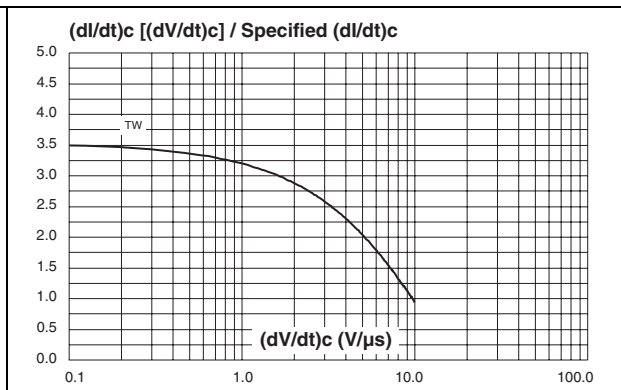

Figure 11. Relative variation of critical rate of decrease of main current versus junction temperature

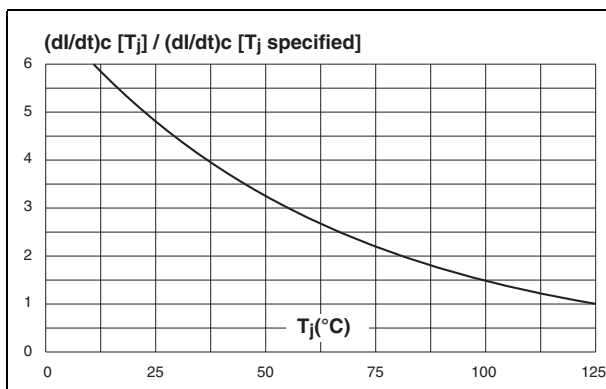
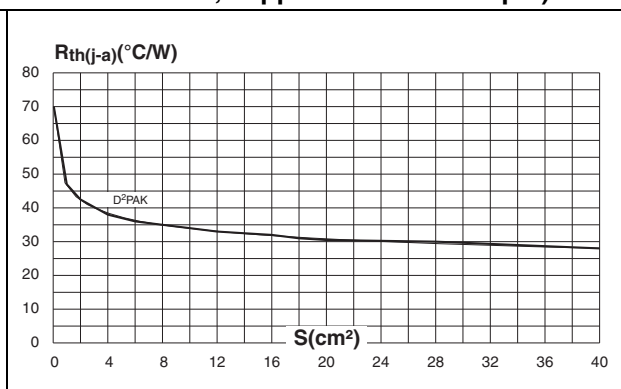

Figure 12. D²PAK thermal resistance junction to ambient versus copper surface under tab (printed circuit board FR4, copper thickness: 35 μm)



2 Ordering information scheme

Figure 13. BTA12 and BTB12 series



Figure 14. T12xx series



Table 7. Product selector

| Order code ⁽¹⁾ | Voltage (xxx) | | Sensitivity | Type | Package |
|---------------------------|---------------|-------|-------------|-------------|--------------------|
| | 600 V | 800 V | | | |
| BTA/BTB12-xxxBRG | X | X | 50 mA | Standard | TO-220AB |
| BTA/BTB12-xxxBWRG | X | X | 50 mA | Snubberless | TO-220AB |
| BTA/BTB12-xxxCRG | X | X | 25 mA | Standard | TO-220AB |
| BTA/BTB12-xxxCWRG | X | X | 35 mA | Snubberless | TO-220AB |
| BTA/BTB12-xxxSWRG | X | X | 10 mA | Logic Level | TO-220AB |
| BTA/BTB12-xxxTWRG | X | X | 5 mA | Logic Level | TO-220AB |
| T1210-800G | - | X | 10 mA | Logic Level | D ² PAK |
| T1235-xxxG | X | X | 35 mA | Snubberless | D ² PAK |
| T1235-xxxR | X | X | 35 mA | Snubberless | I ² PAK |
| T1250-600G | X | - | 50 mA | Snubberless | D ² PAK |

1. **BTB**: non insulated TO-220AB package

3 Packaging information

- Epoxy meets UL94, V0

In order to meet environmental requirements, ST offers these devices in ECOPACK® packages. These packages have a lead-free second level interconnect. The category of second level interconnect is marked on the package and on the inner box label, in compliance with JEDEC Standard JESD97. The maximum ratings related to soldering conditions are also marked on the inner box label. ECOPACK is an ST trademark. ECOPACK specifications are available at: www.st.com.

Table 8. D²PAK dimensions

| Ref. | Dimensions | | | | | |
|------|-------------|------|-------|--------|-------|-------|
| | Millimeters | | | Inches | | |
| | Min. | Typ. | Max. | Min. | Typ. | Max. |
| A | 4.30 | | 4.60 | 0.169 | | 0.181 |
| A1 | 2.49 | | 2.69 | 0.098 | | 0.106 |
| A2 | 0.03 | | 0.23 | 0.001 | | 0.009 |
| B | 0.70 | | 0.93 | 0.027 | | 0.037 |
| B2 | 1.25 | 1.40 | | 0.048 | 0.055 | |
| C | 0.45 | | 0.60 | 0.017 | | 0.024 |
| C2 | 1.21 | | 1.36 | 0.047 | | 0.054 |
| D | 8.95 | | 9.35 | 0.352 | | 0.368 |
| E | 10.00 | | 10.28 | 0.393 | | 0.405 |
| G | 4.88 | | 5.28 | 0.192 | | 0.208 |
| L | 15.00 | | 15.85 | 0.590 | | 0.624 |
| L2 | 1.27 | | 1.40 | 0.050 | | 0.055 |
| L3 | 1.40 | | 1.75 | 0.055 | | 0.069 |
| R | 0.40 | | | 0.016 | | |
| V2 | 0° | | 8° | 0° | | 8° |

Figure 15. Footprint (dimensions in mm)

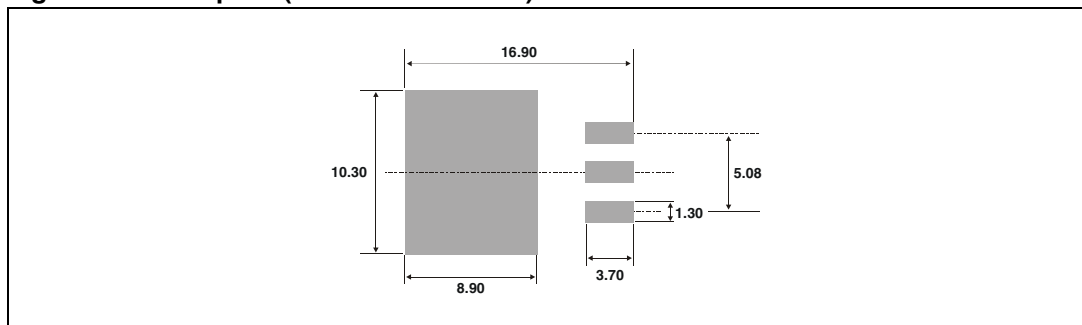
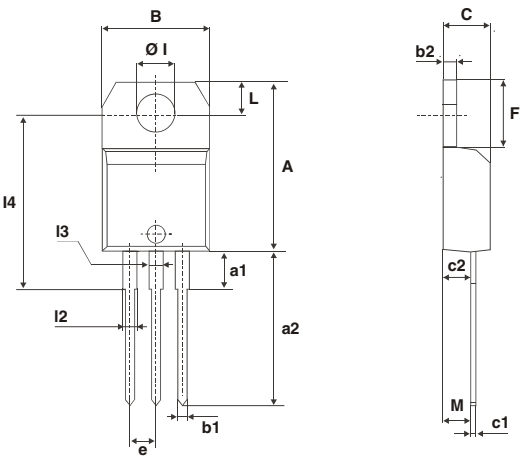

Table 9. I²PAK dimensions

| Ref. | Dimensions | | | | | |
|------|-------------|------|-------|--------|-------|-------|
| | Millimeters | | | Inches | | |
| | Min. | Typ. | Max. | Min. | Typ. | Max. |
| A | 4.30 | | 4.60 | 0.169 | | 0.181 |
| A1 | 2.49 | | 2.69 | 0.098 | | 0.106 |
| b | 0.70 | | 0.93 | 0.028 | | 0.037 |
| b1 | 1.20 | | 1.38 | 0.047 | | 0.054 |
| b2 | 1.25 | 1.40 | | 0.049 | 0.055 | |
| c | 0.45 | | 0.60 | 0.018 | | 0.024 |
| c2 | 1.21 | | 1.36 | 0.048 | | 0.054 |
| D | 8.95 | | 9.35 | 0.352 | | 0.368 |
| e | 2.44 | | 2.64 | 0.096 | | 0.104 |
| E | 10.00 | | 10.28 | 0.394 | | 0.405 |
| L | 13.10 | | 13.60 | 0.516 | | 0.535 |
| L1 | | 3.75 | | | 0.148 | |
| L2 | 1.27 | | 1.40 | 0.050 | | 0.055 |
| V | | 5° | | | 5° | |
| V4 | | 45° | | | 45° | |

Table 10. TO-220AB dimensions (insulated and non-insulated)



| Ref. | Dimensions | | | | | |
|------|-------------|-------|-------|--------|-------|-------|
| | Millimeters | | | Inches | | |
| | Min. | Typ. | Max. | Min. | Typ. | Max. |
| A | 15.20 | | 15.90 | 0.598 | | 0.625 |
| a1 | | 3.75 | | | 0.147 | |
| a2 | 13.00 | | 14.00 | 0.511 | | 0.551 |
| B | 10.00 | | 10.40 | 0.393 | | 0.409 |
| b1 | 0.61 | | 0.88 | 0.024 | | 0.034 |
| b2 | 1.23 | | 1.32 | 0.048 | | 0.051 |
| C | 4.40 | | 4.60 | 0.173 | | 0.181 |
| c1 | 0.49 | | 0.70 | 0.019 | | 0.027 |
| c2 | 2.40 | | 2.72 | 0.094 | | 0.107 |
| e | 2.40 | | 2.70 | 0.094 | | 0.106 |
| F | 6.20 | | 6.60 | 0.244 | | 0.259 |
| ØI | 3.75 | | 3.85 | 0.147 | | 0.151 |
| I4 | 15.80 | 16.40 | 16.80 | 0.622 | 0.646 | 0.661 |
| L | 2.65 | | 2.95 | 0.104 | | 0.116 |
| I2 | 1.14 | | 1.70 | 0.044 | | 0.066 |
| I3 | 1.14 | | 1.70 | 0.044 | | 0.066 |
| M | | 2.60 | | | 0.102 | |

4 Ordering information

Table 11. Ordering information

| Order code | Marking | Package | Weight | Base qty | Delivery mode |
|-------------------|------------------|--------------------|--------|----------|---------------|
| BTA/BTB12-xxxzyRG | BTA/BTB12-xxxzyz | TO-220AB | 2.3 g | 50 | Tube |
| T1210-xxxG-TR | T1210-xxxG | D ² PAK | 1.5 g | 1000 | Tape and reel |
| T1235-xxxG | T1235xxxG | D ² PAK | 1.5 g | 50 | Tube |
| T1235-xxxG-TR | T1235xxxG | | | 1000 | Tape and reel |
| T1235-xxxR | T1235-xxxR | I ² PAK | 1.5 g | 50 | Tube |
| T1250-xxxG-TR | T1250xxxG | D ² PAK | 1.5 g | 1000 | Tape and reel |

Note: xxx = voltage, y = sensitivity, z = type

5 Revision history

Table 12. Revision history

| Date | Revision | Changes |
|-------------|----------|--|
| Sep-2002 | 6A | Last update. |
| 25-Mar-2005 | 7 | 1. I ² PAK package added. 2. TO-220AB delivery mode changed from bulk to tube. |
| 27-May-2005 | 8 | T1210 added |
| 28-Sep-2007 | 9 | Reformatted to current standards. T1250 added |

Please Read Carefully:

Information in this document is provided solely in connection with ST products. STMicroelectronics NV and its subsidiaries ("ST") reserve the right to make changes, corrections, modifications or improvements, to this document, and the products and services described herein at any time, without notice.

All ST products are sold pursuant to ST's terms and conditions of sale.

Purchasers are solely responsible for the choice, selection and use of the ST products and services described herein, and ST assumes no liability whatsoever relating to the choice, selection or use of the ST products and services described herein.

No license, express or implied, by estoppel or otherwise, to any intellectual property rights is granted under this document. If any part of this document refers to any third party products or services it shall not be deemed a license grant by ST for the use of such third party products or services, or any intellectual property contained therein or considered as a warranty covering the use in any manner whatsoever of such third party products or services or any intellectual property contained therein.

UNLESS OTHERWISE SET FORTH IN ST'S TERMS AND CONDITIONS OF SALE ST DISCLAIMS ANY EXPRESS OR IMPLIED WARRANTY WITH RESPECT TO THE USE AND/OR SALE OF ST PRODUCTS INCLUDING WITHOUT LIMITATION IMPLIED WARRANTIES OF MERCHANTABILITY, FITNESS FOR A PARTICULAR PURPOSE (AND THEIR EQUIVALENTS UNDER THE LAWS OF ANY JURISDICTION), OR INFRINGEMENT OF ANY PATENT, COPYRIGHT OR OTHER INTELLECTUAL PROPERTY RIGHT.

UNLESS EXPRESSLY APPROVED IN WRITING BY AN AUTHORIZED ST REPRESENTATIVE, ST PRODUCTS ARE NOT RECOMMENDED, AUTHORIZED OR WARRANTED FOR USE IN MILITARY, AIR CRAFT, SPACE, LIFE SAVING, OR LIFE SUSTAINING APPLICATIONS, NOR IN PRODUCTS OR SYSTEMS WHERE FAILURE OR MALFUNCTION MAY RESULT IN PERSONAL INJURY, DEATH, OR SEVERE PROPERTY OR ENVIRONMENTAL DAMAGE. ST PRODUCTS WHICH ARE NOT SPECIFIED AS "AUTOMOTIVE GRADE" MAY ONLY BE USED IN AUTOMOTIVE APPLICATIONS AT USER'S OWN RISK.

Resale of ST products with provisions different from the statements and/or technical features set forth in this document shall immediately void any warranty granted by ST for the ST product or service described herein and shall not create or extend in any manner whatsoever, any liability of ST.

ST and the ST logo are trademarks or registered trademarks of ST in various countries.

Information in this document supersedes and replaces all information previously supplied.

The ST logo is a registered trademark of STMicroelectronics. All other names are the property of their respective owners.

© 2007 STMicroelectronics - All rights reserved

STMicroelectronics group of companies

Australia - Belgium - Brazil - Canada - China - Czech Republic - Finland - France - Germany - Hong Kong - India - Israel - Italy - Japan - Malaysia - Malta - Morocco - Singapore - Spain - Sweden - Switzerland - United Kingdom - United States of America

www.st.com

Mouser Electronics

Authorized Distributor

Click to View Pricing, Inventory, Delivery & Lifecycle Information:

[STMicroelectronics:](#)

[BTA12-700CWRG](#) [BTA12-700SWRG](#) [BTB12-700CRG](#) [T1205-600G](#) [BTA12-400BRG](#) [BTB12-700SWRG](#) [BTA12-700CRG](#)