

MURD620CT, NRVUD620CT, SRVUD620CT, SNRVUD620CT

Switch-mode Power Rectifier

DPAK Surface Mount Package

These state-of-the-art devices are designed for use in switching power supplies, inverters and as free wheeling diodes.

Features

- Ultrafast 35 Nanosecond Recovery Time
- Low Forward Voltage Drop
- Low Leakage
- ESD Rating:
 - ◆ Human Body Model = 3B (> 8 kV)
 - ◆ Machine Model = C (> 400 V)
- NRVUD, SRVUD and SNRVUD Prefixes for Automotive and Other Applications Requiring Unique Site and Control Change Requirements; AEC-Q101 Qualified and PPAP Capable
- These Devices are Pb-Free, Halogen Free/BFR Free and are RoHS Compliant

Mechanical Characteristics:

- Case: Epoxy, Molded
- Weight: 0.4 Gram (Approximately)
- Finish: All External Surfaces Corrosion Resistant and Terminal Leads are Readily Solderable
- Lead and Mounting Surface Temperature for Soldering Purposes: 260°C Max. for 10 Seconds



ON Semiconductor®

www.onsemi.com

ULTRAFAST RECTIFIER
6.0 AMPERES
200 VOLTS

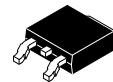

DPAK
CASE 369C

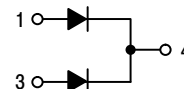

MARKING DIAGRAMS

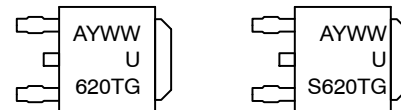

A = Assembly Location*
Y = Year
WW = Work Week
U620T = Device Code (MURD/NRVUD/
SNRVUD620CT)
US620T = Device Code (SRVUD620CT)
G = Pb-Free Package

* The Assembly Location Code (A) is front side optional. In cases where the Assembly Location is stamped in the package bottom (molding ejector pin), the front side assembly code may be blank.

ORDERING INFORMATION

Device	Package	Shipping [†]
MURD620CTG	DPAK (Pb-Free)	75 Units / Rail
NRVUD620CTG	DPAK (Pb-Free)	75 Units / Rail
MURD620CTT4G	DPAK (Pb-Free)	2,500 / Tape & Reel
NRVUD620CTT4G	DPAK (Pb-Free)	2,500 / Tape & Reel
SRVUD620CTT4G	DPAK (Pb-Free)	2,500 / Tape & Reel
SNRVUD620CTT4G	DPAK (Pb-Free)	2,500 / Tape & Reel
NRVUD620CTG-VF01	DPAK (Pb-Free)	2,500 / Tape & Reel

[†]For information on tape and reel specifications, including part orientation and tape sizes, please refer to our Tape and Reel Packaging Specifications Brochure, BRD8011/D.

MURD620CT, NRVUD620CT, SRVUD620CT, SNRVUD620CT

MAXIMUM RATINGS

Rating	Symbol	Value	Unit
Peak Repetitive Reverse Voltage Working Peak Reverse Voltage DC Blocking Voltage	V_{RRM} V_{RWM} V_R	200	V
Average Rectified Forward Current (Rated V_R , $T_C = 140^\circ\text{C}$) Per Diode Per Device	$I_{F(AV)}$	3.0 6.0	A
Peak Repetitive Forward Current (Rated V_R , Square Wave, 20 kHz, $T_C = 145^\circ\text{C}$) Per Diode	I_F	6.0	A
Non-Repetitive Peak Surge Current (Surge Applied at Rated Load Conditions Halfwave, 60 Hz)	I_{FSM}	50	A
Operating Junction and Storage Temperature Range	T_J, T_{stg}	-65 to +175	$^\circ\text{C}$

Stresses exceeding those listed in the Maximum Ratings table may damage the device. If any of these limits are exceeded, device functionality should not be assumed, damage may occur and reliability may be affected.

THERMAL CHARACTERISTICS (Per Diode)

Characteristic	Symbol	Value	Unit
Thermal Resistance, Junction-to-Case	$R_{\theta JC}$	9	$^\circ\text{C}/\text{W}$
Thermal Resistance, Junction-to-Ambient (Note 1)	$R_{\theta JA}$	80	$^\circ\text{C}/\text{W}$

1. Rating applies when surface mounted on the minimum pad sizes recommended.

ELECTRICAL CHARACTERISTICS (Per Diode)

Characteristic	Symbol	Value	Unit
Maximum Instantaneous Forward Voltage Drop (Note 2) ($I_F = 3$ Amps, $T_C = 25^\circ\text{C}$) ($I_F = 3$ Amps, $T_C = 125^\circ\text{C}$) ($I_F = 6$ Amps, $T_C = 25^\circ\text{C}$) ($I_F = 6$ Amps, $T_C = 125^\circ\text{C}$)	V_F	1 0.96 1.2 1.13	V
Maximum Instantaneous Reverse Current (Note 2) ($T_J = 25^\circ\text{C}$, Rated dc Voltage) ($T_J = 125^\circ\text{C}$, Rated dc Voltage)	i_R	5 250	μA
Maximum Reverse Recovery Time ($I_F = 1$ Amp, $di/dt = 50$ Amps/ μs , $V_R = 30$ V, $T_J = 25^\circ\text{C}$) ($I_F = 0.5$ Amp, $i_R = 1$ Amp, $I_{REC} = 0.25$ A, $V_R = 30$ V, $T_J = 25^\circ\text{C}$)	t_{rr}	35 25	ns

Product parametric performance is indicated in the Electrical Characteristics for the listed test conditions, unless otherwise noted. Product performance may not be indicated by the Electrical Characteristics if operated under different conditions.

2. Pulse Test: Pulse Width = 300 μs , Duty Cycle $\leq 2.0\%$.

TYPICAL CHARACTERISTICS

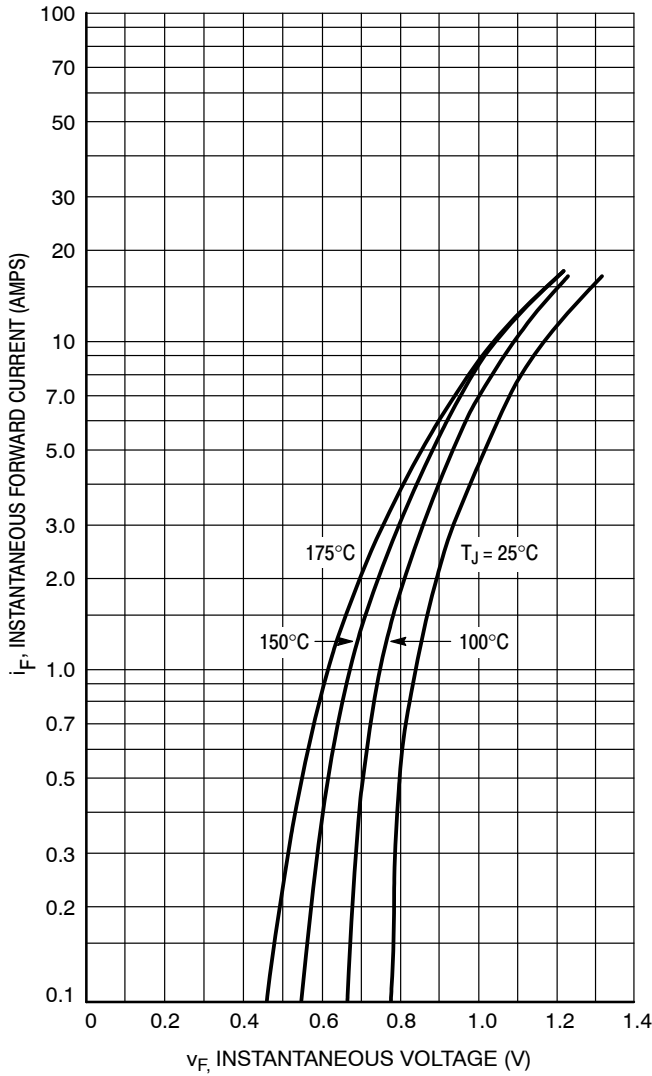

Figure 1. Typical Forward Voltage (Per Leg)

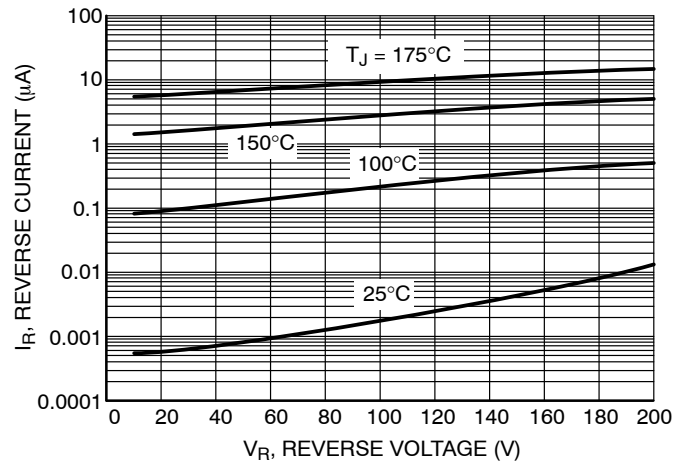

Figure 2. Typical Leakage Current* (Per Leg)

* The curves shown are typical for the highest voltage device in the voltage grouping. Typical reverse current for lower voltage selections can be estimated from these curves if V_R is sufficiently below rated V_R .

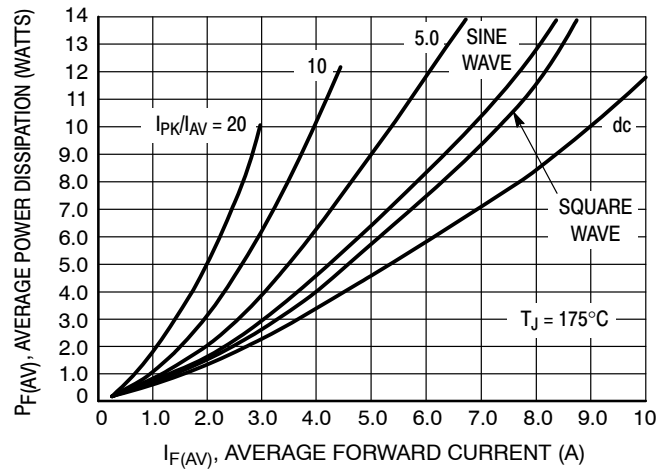

Figure 3. Average Power Dissipation (Per Leg)

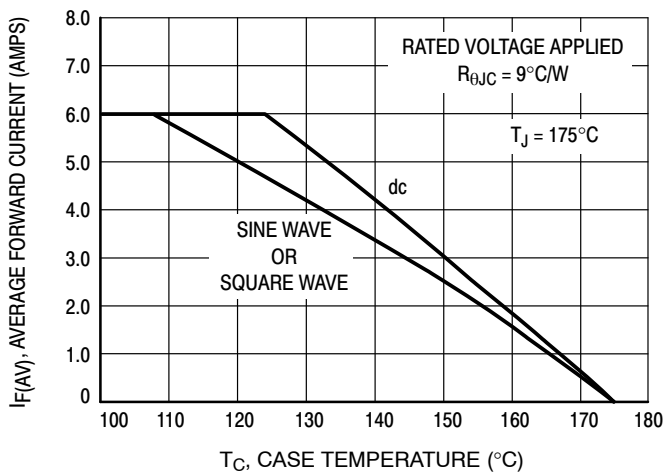

Figure 4. Current Derating, Case (Per Leg)

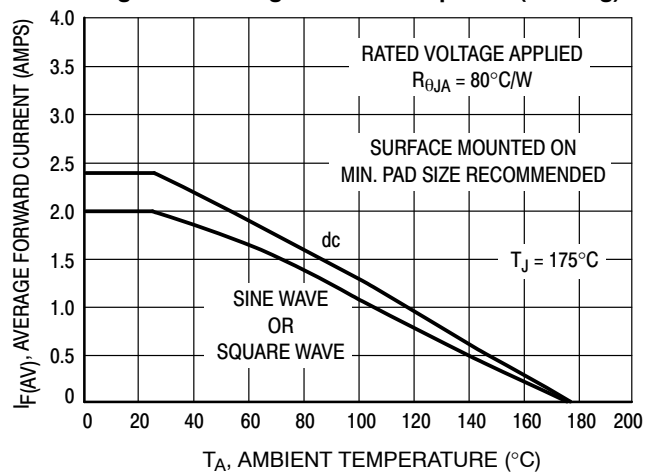

Figure 5. Current Derating, Ambient (Per Leg)

TYPICAL CHARACTERISTICS

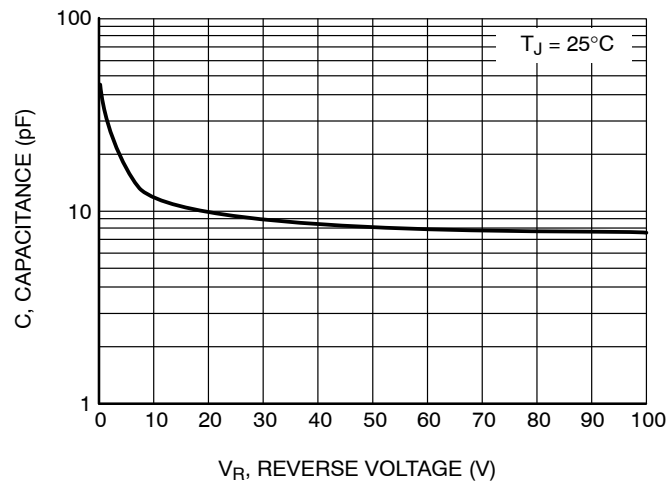
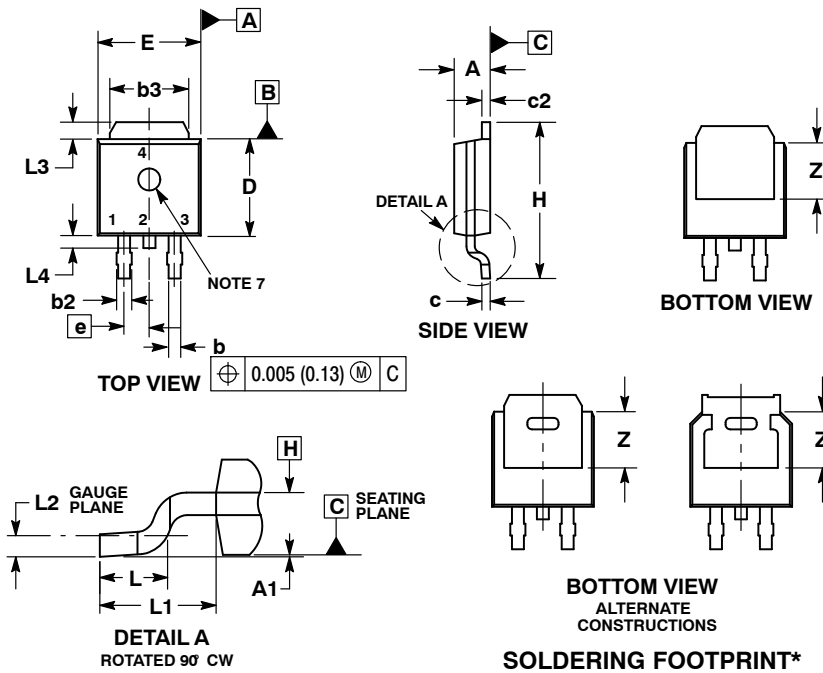

Figure 6. Typical Capacitance (Per Leg)

MURD620CT, NRVUD620CT, SRVUD620CT, SNRVUD620CT

PACKAGE DIMENSIONS

DPAK (SINGLE GAUGE) CASE 369C ISSUE F



NOTES:

1. DIMENSIONING AND TOLERANCING PER ASME Y14.5M, 1994.
2. CONTROLLING DIMENSION: INCHES.
3. THERMAL PAD CONTOUR OPTIONAL WITHIN DIMENSIONS b3, L3 and Z.
4. DIMENSIONS D AND E DO NOT INCLUDE MOLD FLASH, PROTRUSIONS, OR BURRS. MOLD FLASH, PROTRUSIONS, OR GATE BURRS SHALL NOT EXCEED 0.006 INCHES PER SIDE.
5. DIMENSIONS D AND E ARE DETERMINED AT THE OUTERMOST EXTREMES OF THE PLASTIC BODY.
6. DATUMS A AND B ARE DETERMINED AT DATUM PLANE H.
7. OPTIONAL MOLD FEATURE.

DIM	INCHES		MILLIMETERS	
	MIN	MAX	MIN	MAX
A	0.086	0.094	2.18	2.38
A1	0.000	0.005	0.00	0.13
b	0.025	0.035	0.63	0.89
b2	0.028	0.045	0.72	1.14
b3	0.180	0.215	4.57	5.46
c	0.018	0.024	0.46	0.61
c2	0.018	0.024	0.46	0.61
D	0.235	0.245	5.97	6.22
E	0.250	0.265	6.35	6.73
e	0.090	BSC	2.29	BSC
H	0.370	0.410	9.40	10.41
L	0.055	0.070	1.40	1.78
L1	0.114	REF	2.90	REF
L2	0.020	BSC	0.51	BSC
L3	0.035	0.050	0.89	1.27
L4	---	0.040	---	1.01
Z	0.155	---	3.93	---

SCALE 3:1 $\left(\frac{\text{mm}}{\text{inches}} \right)$

*For additional information on our Pb-Free strategy and soldering details, please download the ON Semiconductor Soldering and Mounting Techniques Reference Manual, SOLDERRM/D.

ON Semiconductor and are trademarks of Semiconductor Components Industries, LLC dba ON Semiconductor or its subsidiaries in the United States and/or other countries. ON Semiconductor owns the rights to a number of patents, trademarks, copyrights, trade secrets, and other intellectual property. A listing of ON Semiconductor's product/patent coverage may be accessed at www.onsemi.com/site/pdf/Patent-Marking.pdf. ON Semiconductor reserves the right to make changes without further notice to any products herein. ON Semiconductor makes no warranty, representation or guarantee regarding the suitability of its products for any particular purpose, nor does ON Semiconductor assume any liability arising out of the application or use of any product or circuit, and specifically disclaims any and all liability, including without limitation special, consequential or incidental damages. Buyer is responsible for its products and applications using ON Semiconductor products, including compliance with all laws, regulations and safety requirements or standards, regardless of any support or applications information provided by ON Semiconductor. "Typical" parameters which may be provided in ON Semiconductor data sheets and/or specifications can and do vary in different applications and actual performance may vary over time. All operating parameters, including "Typicals" must be validated for each customer application by customer's technical experts. ON Semiconductor does not convey any license under its patent rights nor the rights of others. ON Semiconductor products are not designed, intended, or authorized for use as a critical component in life support systems or any FDA Class 3 medical devices or medical devices with a same or similar classification in a foreign jurisdiction or any devices intended for implantation in the human body. Should Buyer purchase or use ON Semiconductor products for any such unintended or unauthorized application, Buyer shall indemnify and hold ON Semiconductor and its officers, employees, subsidiaries, affiliates, and distributors harmless against all claims, costs, damages, and expenses, and reasonable attorney fees arising out of, directly or indirectly, any claim of personal injury or death associated with such unintended or unauthorized use, even if such claim alleges that ON Semiconductor was negligent regarding the design or manufacture of the part. ON Semiconductor is an Equal Opportunity/Affirmative Action Employer. This literature is subject to all applicable copyright laws and is not for resale in any manner.

PUBLICATION ORDERING INFORMATION

LITERATURE FULFILLMENT:

Literature Distribution Center for ON Semiconductor
 19521 E. 32nd Pkwy, Aurora, Colorado 80011 USA
Phone: 303-675-2175 or 800-344-3860 Toll Free USA/Canada
Fax: 303-675-2176 or 800-344-3867 Toll Free USA/Canada
Email: orderlit@onsemi.com

N. American Technical Support: 800-282-9855 Toll Free
 USA/Canada
Europe, Middle East and Africa Technical Support:
 Phone: 421 33 790 2910
Japan Customer Focus Center
 Phone: 81-3-5817-1050

ON Semiconductor Website: www.onsemi.com

Order Literature: <http://www.onsemi.com/orderlit>

For additional information, please contact your local Sales Representative

Mouser Electronics

Authorized Distributor

Click to View Pricing, Inventory, Delivery & Lifecycle Information:

[ON Semiconductor:](#)

[MURD620CTG](#) [MURD620CTT4G](#) [NRVUD620CTG](#) [SRVUD620CTT4G](#)