

## Description

The AZ1117C is a low dropout three-terminal regulator.

The AZ1117C has been optimized for low voltage where transient response and minimum input voltage are critical. It provides current limit and thermal shutdown. Its circuit includes a trimmed bandgap reference to assure output voltage accuracy to be within  $\pm 1\%$ . On-chip thermal shutdown provides protection against a combination of high current and ambient temperature that would create excessive junction temperature.

The AZ1117C is available in 1.2V, 1.5V, 1.8V, 2.5V, 3.3V, 5.0V fixed output voltage versions and ADJ output voltage version. The fixed versions integrate the adjust resistors. It is also available in an adjustable version which can set the output voltage with two external resistors.

The AZ1117C is available in the industry-standard TO252-2 Series (including TO252-2 (3), TO252-2 (4), and TO252-2 (5)), SOT89 and SOT223 power packages.

- Notes:
1. No purposely added lead. Fully EU Directive 2002/95/EC (RoHS) & 2011/65/EU (RoHS 2) compliant.
  2. See [http://www.diodes.com/quality/lead\\_free.html](http://www.diodes.com/quality/lead_free.html) for more information about Diodes Incorporated's definitions of Halogen- and Antimony-free, "Green" and Lead-free.
  3. Halogen- and Antimony-free "Green" products are defined as those which contain <900ppm bromine, <900ppm chlorine (<1500ppm total Br + Cl) and <1000ppm antimony compounds.

## Features

- Current Limit: 1.35A (Typ)
- Output Noise from 10Hz to 10KHz: 0.003% of  $V_{OUT}$
- PSRR at  $I_{OUT} = 300mA$  and  $f = 120Hz$ : 70dB
- Output Voltage Accuracy:  $\pm 1\%$  (Except 1.2V Version)
- On-chip Thermal Shutdown
- Maximum Quiescent Current:  $I_{QMAX} = 6mA$
- Compatible with Low ESR Ceramic Capacitor
- Operation Junction Temperature:  $-20^{\circ}C$  to  $+125^{\circ}C$
- **Totally Lead-Free & Fully RoHS Compliant (Notes 1 & 2)**
- **Halogen and Antimony Free. "Green" Device (Note 3)**

## Applications

- USB Device
- Add-on Card
- DVD Player
- PC Motherboard

## Pin Assignments

(Top View)

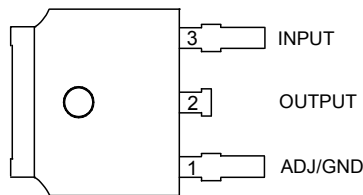

TO252-2 (3) Option 1

(Top View)

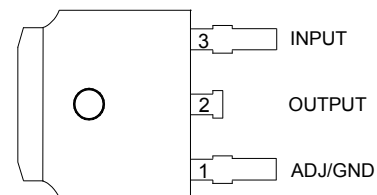

TO252-2 (3) Option 2

(Top View)

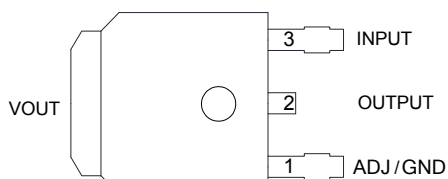

TO252-2 (4)

(Top View)

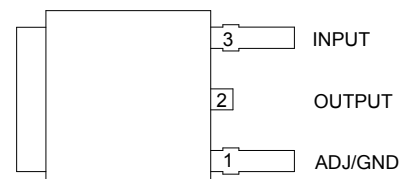

TO252-2 (5)

**Pin Assignments** (Cont.)

(Top View)

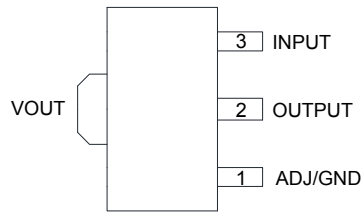

**SOT89 Option 1/ R Package**

(Top View)

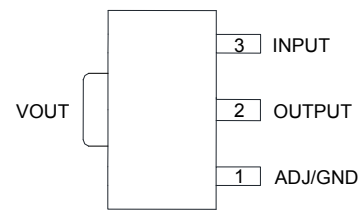

**SOT89 Option 2/ R Package**

(Top View)

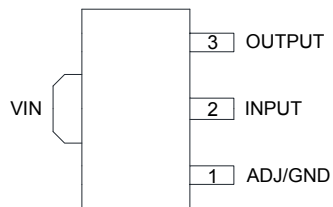

**SOT89 Option 1/ R2 Package**

(Top View)

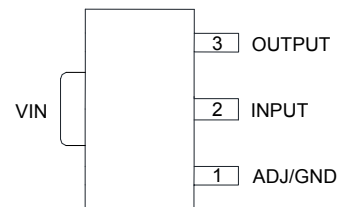

**SOT89 Option 2/ R2 Package**

(Top View)

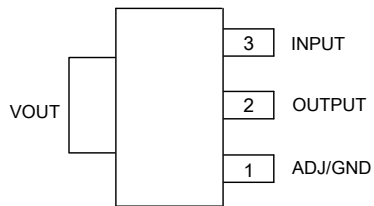

**SOT223/ H Package**

(Top View)

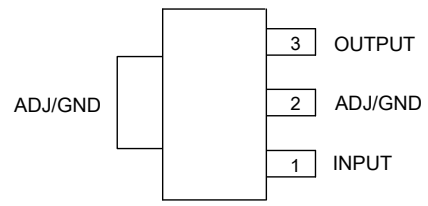

**SOT223/ H2 Package**

**Typical Applications Circuit** (Note 4)

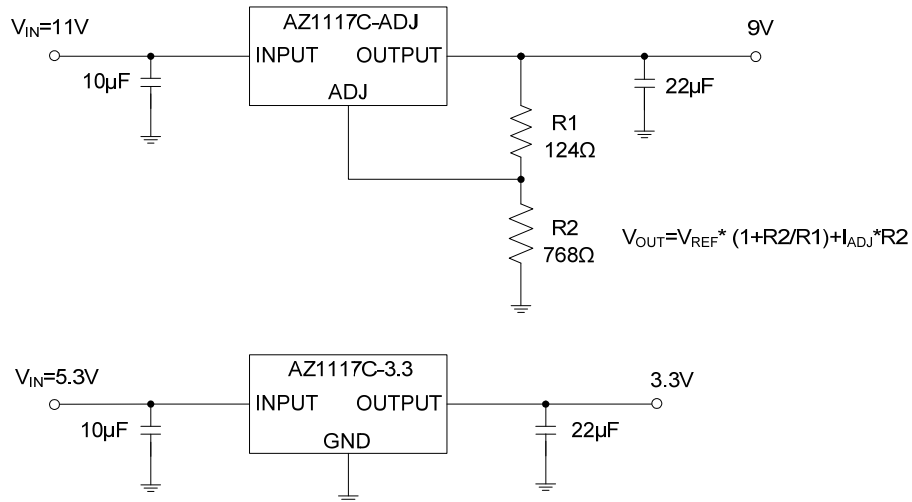

Note 4: The AZ1117C is compatible with low ESR ceramic capacitor. The ESR of the output capacitors must be less than 20Ω. A minimum of 10µF output capacitor is required.

**Functional Block Diagram**

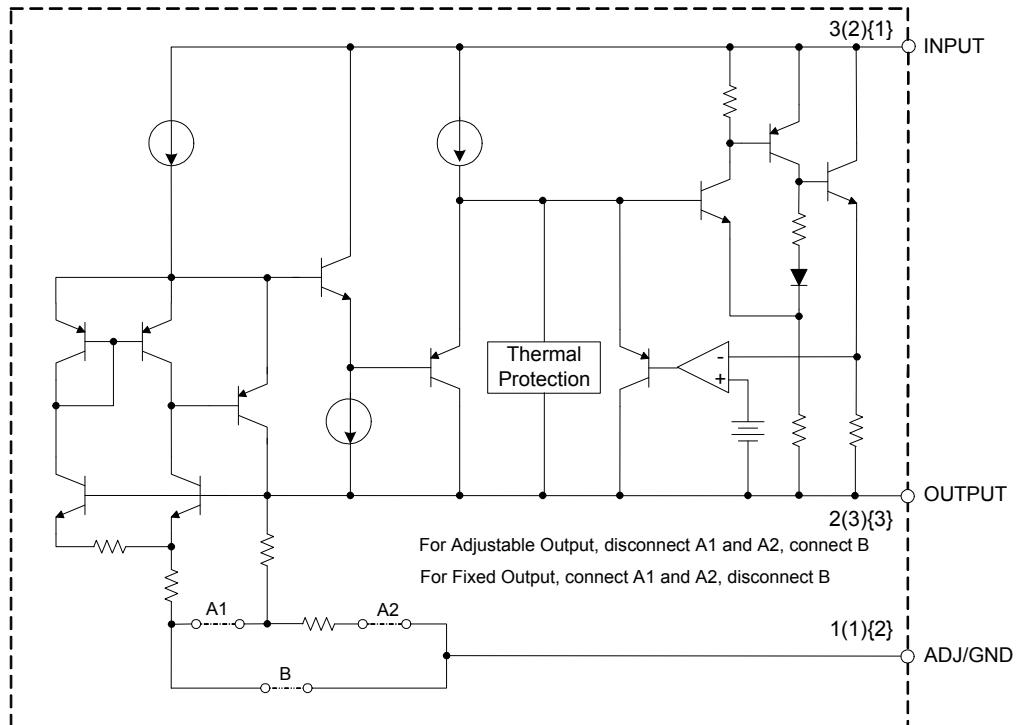

A(B){C}  
A for TO252-2 Series/SOT223 (H)/SOT89 (R)  
B for SOT89 (R2)  
C for SOT223 (H2)

## Absolute Maximum Ratings (Note 5)

Symbol	Parameter	Rating	Unit
V <sub>IN</sub>	Input Voltage	18	V
T <sub>J</sub>	Operating Junction Temperature Range	+150	°C
T <sub>STG</sub>	Storage Temperature Range	-65 to +150	°C
θ <sub>JA</sub>	Thermal Resistance (Without Heatsink)	SOT89	170
		SOT223	125
		TO252-2 Series	100
θ <sub>JA</sub>	Thermal Resistance (With Heatsink) (Note 6)	SOT89	150
		SOT223	100
		TO252-2 Series	70
T <sub>LEAD</sub>	Lead Temperature (Soldering, 10sec)	+260	°C

Notes: 5. Stresses greater than those listed under "Absolute Maximum Ratings" may cause permanent damage to the device. These are stress ratings only, and functional operation of the device at these or any other conditions beyond those indicated under "Recommended Operating Conditions" is not implied. Exposure to "Absolute Maximum Ratings" for extended periods may affect device reliability.  
6. Chip is soldered to 100mm<sup>2</sup>(10mm\*10mm) copper (top side solder mask) on 2oz.2 layers FR-4 PCB with 8\*0.5mm vias.

## Recommended Operating Conditions

Symbol	Parameter	Min	Max	Unit
V <sub>IN</sub>	Input Voltage	—	15	V
T <sub>J</sub>	Operating Junction Temperature Range	-20	+125	°C

## Electrical Characteristics AZ1117C-ADJ

(Operating Conditions: V<sub>IN</sub> = V<sub>OUT</sub>+2V, I<sub>OUT</sub> = 10mA, T<sub>J</sub> = +25°C, unless otherwise specified. (P ≤ maximum power dissipation). Limits appearing in **Boldface** type apply over the entire junction temperature range for operation, -20°C to +125°C.)

Symbol	Parameter	Conditions	Min	Typ	Max	Unit	
V <sub>REF</sub>	Reference Voltage	1.5V ≤ V <sub>IN</sub> -V <sub>OUT</sub> ≤ 10V	1.238	1.250	1.262	V	
			<b>1.225</b>	1.250	<b>1.270</b>		
V <sub>RLINE</sub>	Line Regulation	1.5V ≤ V <sub>IN</sub> -V <sub>OUT</sub> ≤ 10V	—	0.001	0.1	%	
			—	—	<b>0.2</b>		
V <sub>RLOAD</sub>	Load Regulation	—	—	0.4	1.0	%	
V <sub>DROP</sub>	Dropout Voltage	ΔV <sub>REF</sub> = 1%, I <sub>OUT</sub> = 0.8A	SOT223	—	1.2	1.3	V
			TO252-2 Series	—	1.3	1.4	V
I <sub>LIMIT</sub>	Current Limit	—	1	1.35	—	A	
—	Adjust Pin Current	—	—	60	<b>120</b>	μA	
—	Adjust Pin Current Change	1.5 ≤ (V <sub>IN</sub> -V <sub>OUT</sub> ) ≤ 10V	—	0.2	<b>5</b>	μA	
—	Minimum Load Current	1.5 ≤ (V <sub>IN</sub> -V <sub>OUT</sub> ) ≤ 10V	—	1.7	<b>5</b>	mA	
PSRR	Ripple Rejection	f = 120Hz, C <sub>OUT</sub> = 22μF (V <sub>IN</sub> -V <sub>OUT</sub> ) = 3V, I <sub>OUT</sub> = 300mA	—	70	—	dB	
—	Temperature Stability	—	—	0.5	—	%	
—	RMS Output Noise (% of V <sub>OUT</sub> )	T <sub>A</sub> = +25°C, 10Hz ≤ f ≤ 10KHz	—	0.003	—	%	
—	Thermal Shutdown	Junction Temperature	—	+160	—	°C	
—	Thermal Shutdown Hysteresis	—	—	+16	—	°C	
θ <sub>JC</sub>	Thermal Resistance (Junction to Case)	SOT89	—	30	—	°C/W	
		SOT223	—	15	—		
		TO252-2 Series	—	10	—		

### Electrical Characteristics AZ1117C-1.2 (Cont.)

(Operating Conditions:  $V_{IN} \leq 10V$ ,  $I_{OUT} = 10mA$ ,  $T_J = +25^\circ C$ , unless otherwise specified. ( $P \leq$  maximum power dissipation). Limits appearing in **Boldface** type apply over the entire junction temperature range for operation,  $-20^\circ C$  to  $+125^\circ C$ .)

Symbol	Parameter	Conditions	Min	Typ	Max	Unit	
$V_{OUT}$	Output Voltage	$1.5V \leq V_{IN} - V_{OUT} \leq 10V$	1.176	1.2	1.224	V	
			<b>1.152</b>	1.2	<b>1.228</b>		
$V_{RLINE}$	Line Regulation	$1.5V \leq V_{IN} - V_{OUT} \leq 10V$	—	0.5	6	mV	
			—	—	<b>10</b>		
$V_{RLOAD}$	Load Regulation	—	—	2	15	mV	
$V_{DROP}$	Dropout Voltage	$\Delta V_{OUT} = 1\%$ , $I_{OUT} = 0.8A$	SOT223	—	1.2	1.3	V
			TO252-2 Series	—	1.3	1.4	V
$I_{LIMIT}$	Current Limit	—	1	1.35	—	A	
$I_Q$	Quiescent Current	$I_{OUT} = 0$	—	4	<b>6</b>	mA	
PSRR	Ripple Rejection	$f = 120Hz$ , $C_{OUT} = 22\mu F$ $(V_{IN} - V_{OUT}) = 3V$ , $I_{OUT} = 300mA$	—	70	—	dB	
	Temperature Stability	—	—	0.5	—		%
—	RMS Output Noise (% of $V_{OUT}$ )	$T_A = +25^\circ C$ , $10Hz \leq f \leq 10KHz$	—	0.003	—	%	
—	Thermal Shutdown	Junction Temperature	—	+160	—	$^\circ C$	
—	Thermal Shutdown Hysteresis	—	—	+16	—	$^\circ C$	
$\theta_{JC}$	Thermal Resistance (Junction to Case)	SOT89	—	30	—	$^\circ C/W$	
		SOT223	—	15	—		
		TO252-2 Series	—	10	—		

### Electrical Characteristics AZ1117C-1.5 (Cont.)

(Operating Conditions:  $V_{IN} \leq 10V$ ,  $I_{OUT} = 10mA$ ,  $T_J = +25^\circ C$ , unless otherwise specified. ( $P \leq$  maximum power dissipation). Limits appearing in **Boldface** type apply over the entire junction temperature range for operation,  $-20^\circ C$  to  $+125^\circ C$ .)

Symbol	Parameter	Conditions	Min	Typ	Max	Unit	
$V_{OUT}$	Output Voltage	$1.5V \leq V_{IN} - V_{OUT} \leq 10V$	1.485	1.5	1.515	V	
			<b>1.470</b>	1.5	<b>1.530</b>		
$V_{RLINE}$	Line Regulation	$1.5V \leq V_{IN} - V_{OUT} \leq 10V$	—	0.5	6	mV	
			—	—	<b>10</b>		
$V_{RLOAD}$	Load Regulation	—	—	2	15	mV	
$V_{DROP}$	Dropout Voltage	$\Delta V_{OUT} = 1\%$ , $I_{OUT} = 0.8A$	SOT223	—	1.2	1.3	V
			TO252-2 Series	—	1.3	1.4	V
$I_{LIMIT}$	Current Limit	—	1	1.35	—	A	
$I_Q$	Quiescent Current	$I_{OUT} = 0$	—	4	<b>6</b>	mA	
PSRR	Ripple Rejection	$f = 120Hz$ , $C_{OUT} = 22\mu F$ $(V_{IN} - V_{OUT}) = 3V$ , $I_{OUT} = 300mA$	—	70	—	dB	
	Temperature Stability	—	—	0.5	—		%
—	RMS Output Noise (% of $V_{OUT}$ )	$T_A = +25^\circ C$ , $10Hz \leq f \leq 10KHz$	—	0.003	—	%	
—	Thermal Shutdown	Junction Temperature	—	+160	—	$^\circ C$	
—	Thermal Shutdown Hysteresis	—	—	+16	—	$^\circ C$	
$\theta_{JC}$	Thermal Resistance (Junction to Case)	SOT89	—	30	—	$^\circ C/W$	
		SOT223	—	15	—		
		TO252-2 Series	—	10	—		

### Electrical Characteristics AZ1117C-1.8 (Cont.)

(Operating Conditions:  $V_{IN} \leq 10V$ ,  $I_{OUT} = 10mA$ ,  $T_J = +25^\circ C$ , unless otherwise specified. ( $P \leq$  maximum power dissipation). Limits appearing in **Boldface** type apply over the entire junction temperature range for operation,  $-20^\circ C$  to  $+125^\circ C$ .)

Symbol	Parameter	Conditions	Min	Typ	Max	Unit	
$V_{OUT}$	Output Voltage	$1.5V \leq V_{IN} - V_{OUT} \leq 10V$	1.782	1.8	1.818	V	
			<b>1.764</b>	1.8	<b>1.836</b>		
$V_{RLINE}$	Line Regulation	$1.5V \leq V_{IN} - V_{OUT} \leq 10V$	—	0.5	6	mV	
			—	—	<b>10</b>		
$V_{RLOAD}$	Load Regulation	—	—	2	15	mV	
$V_{DROP}$	Dropout Voltage	$\Delta V_{OUT} = 1\%$ , $I_{OUT} = 0.8A$	SOT223	—	1.2	1.3	V
			TO252-2 Series	—	1.3	1.4	V
$I_{LIMIT}$	Current Limit	—	1	1.35	—	A	
$I_Q$	Quiescent Current	$I_{OUT} = 0$	—	4	<b>6</b>	mA	
PSRR	Ripple Rejection	$f = 120Hz$ , $C_{OUT} = 22\mu F$ $(V_{IN} - V_{OUT}) = 3V$ , $I_{OUT} = 300mA$	—	70	—	dB	
—	Temperature Stability	—	—	0.5	—	%	
—	RMS Output Noise (% of $V_{OUT}$ )	$T_A = +25^\circ C$ , $10Hz \leq f \leq 10KHz$	—	0.003	—	%	
—	Thermal Shutdown	Junction Temperature	—	+160	—	$^\circ C$	
—	Thermal Shutdown Hysteresis	—	—	+16	—	$^\circ C$	
$\theta_{JC}$	Thermal Resistance (Junction to Case)	SOT89	—	30	—	$^\circ C/W$	
		SOT223	—	15	—		
		TO252-2 Series	—	10	—		

### Electrical Characteristics AZ1117C-2.5 (Cont.)

(Operating Conditions:  $V_{IN} \leq 10V$ ,  $I_{OUT} = 10mA$ ,  $T_J = +25^\circ C$ , unless otherwise specified. ( $P \leq$  maximum power dissipation). Limits appearing in **Boldface** type apply over the entire junction temperature range for operation,  $-20^\circ C$  to  $+125^\circ C$ .)

Symbol	Parameter	Conditions	Min	Typ	Max	Unit	
$V_{OUT}$	Output Voltage	$1.5V \leq V_{IN} - V_{OUT} \leq 10V$	2.475	2.5	2.525	V	
			<b>2.455</b>	<b>2.5</b>	<b>2.545</b>		
$V_{RLINE}$	Line Regulation	$1.5V \leq V_{IN} - V_{OUT} \leq 10V$	—	0.5	6	mV	
			—	—	<b>10</b>		
$V_{RLOAD}$	Load Regulation	—	—	2	15	mV	
$V_{DROP}$	Dropout Voltage	$\Delta V_{OUT} = 1\%$ , $I_{OUT} = 0.8A$	SOT223	—	1.2	1.3	V
			TO252-2 Series	—	1.3	1.4	V
$I_{LIMIT}$	Current Limit	—	1	1.35	—	A	
$I_Q$	Quiescent Current	$I_{OUT} = 0$	—	4	<b>6</b>	mA	
PSRR	Ripple Rejection	$f = 120Hz$ , $C_{OUT} = 22\mu F$ $(V_{IN} - V_{OUT}) = 3V$ , $I_{OUT} = 300mA$	—	70	—	dB	
—	Temperature Stability	—	—	0.5	—	%	
—	RMS Output Noise (% of $V_{OUT}$ )	$T_A = +25^\circ C$ , $10Hz \leq f \leq 10KHz$	—	0.003	—	%	
—	Thermal Shutdown	Junction Temperature	—	+160	—	$^\circ C$	
—	Thermal Shutdown Hysteresis	—	—	+16	—	$^\circ C$	
$\theta_{JC}$	Thermal Resistance (Junction to Case)	SOT89	—	30	—	$^\circ C/W$	
		SOT223	—	15	—		
		TO252-2 Series	—	10	—		

### Electrical Characteristics AZ1117C-3.3 (Cont.)

(Operating Conditions:  $V_{IN} \leq 10V$ ,  $I_{OUT} = 10mA$ ,  $T_J = +25^\circ C$ , unless otherwise specified. ( $P \leq$  maximum power dissipation). Limits appearing in **Boldface** type apply over the entire junction temperature range for operation,  $-20^\circ C$  to  $+125^\circ C$ .)

Symbol	Parameter	Conditions	Min	Typ	Max	Unit	
$V_{OUT}$	Output Voltage	$1.5V \leq V_{IN}-V_{OUT} \leq 10V$	3.267	3.3	3.333	V	
			<b>3.235</b>	3.3	<b>3.365</b>		
$V_{RLINE}$	Line Regulation	$1.5V \leq V_{IN}-V_{OUT} \leq 10V$	—	0.5	6	mV	
			—	—	<b>10</b>		
$V_{RLOAD}$	Load Regulation	—	—	2	15	mV	
$V_{DROP}$	Dropout Voltage	$\Delta V_{OUT} = 1\%$ , $I_{OUT} = 0.8A$	SOT223	—	1.2	1.3	V
			TO252-2 Series	—	1.3	1.4	V
$I_{LIMIT}$	Current Limit	—	1	1.35	—	A	
$I_Q$	Quiescent Current	$I_{OUT} = 0$	—	4	<b>6</b>	mA	
PSRR	Ripple Rejection	$f = 120Hz$ , $C_{OUT} = 22\mu F$ $(V_{IN}-V_{OUT}) = 3V$ , $I_{OUT} = 300mA$	—	70	—	dB	
—	Temperature Stability	—	—	0.5	—	%	
—	RMS Output Noise (% of $V_{OUT}$ )	$T_A = +25^\circ C$ , $10Hz \leq f \leq 10KHz$	—	0.003	—	%	
—	Thermal Shutdown	Junction Temperature	—	+160	—	$^\circ C$	
—	Thermal Shutdown Hysteresis	—	—	+16	—	$^\circ C$	
$\theta_{JC}$	Thermal Resistance (Junction to Case)	SOT89	—	30	—	$^\circ C/W$	
		SOT223	—	15	—		
		TO252-2 Series	—	10	—		

### Electrical Characteristics AZ1117C-5.0 (Cont.)

(Operating Conditions:  $V_{IN} \leq 10V$ ,  $I_{OUT} = 10mA$ ,  $T_J = +25^\circ C$ , unless otherwise specified. ( $P \leq$  maximum power dissipation). Limits appearing in **Boldface** type apply over the entire junction temperature range for operation,  $-20^\circ C$  to  $+125^\circ C$ .)

Symbol	Parameter	Conditions	Min	Typ	Max	Unit	
$V_{OUT}$	Output Voltage	$1.5V \leq V_{IN}-V_{OUT} \leq 10V$	4.950	5.0	5.050	V	
			<b>4.900</b>	5.0	<b>5.100</b>		
$V_{RLINE}$	Line Regulation	$1.5V \leq V_{IN}-V_{OUT} \leq 10V$	—	0.5	6	mV	
			—	—	<b>10</b>		
$V_{RLOAD}$	Load Regulation	—	—	2	15	mV	
$V_{DROP}$	Dropout Voltage	$\Delta V_{OUT} = 1\%$ , $I_{OUT} = 0.8A$	SOT223	—	1.2	1.3	V
			TO252-2 Series	—	1.3	1.4	V
$I_{LIMIT}$	Current Limit	—	1	1.35	—	A	
$I_Q$	Quiescent Current	$I_{OUT} = 0$	—	4	<b>6</b>	mA	
PSRR	Ripple Rejection	$f = 120Hz$ , $C_{OUT} = 22\mu F$ $(V_{IN}-V_{OUT}) = 3V$ , $I_{OUT} = 300mA$	—	70	—	dB	
—	Temperature Stability	—	—	0.5	—	%	
—	RMS Output Noise (% of $V_{OUT}$ )	$T_A = +25^\circ C$ , $10Hz \leq f \leq 10KHz$	—	0.003	—	%	
—	Thermal Shutdown	Junction Temperature	—	+160	—	$^\circ C$	
—	Thermal Shutdown Hysteresis	—	—	+16	—	$^\circ C$	
$\theta_{JC}$	Thermal Resistance (Junction to Case)	SOT89	—	30	—	$^\circ C/W$	
		SOT223	—	15	—		
		TO252-2 Series	—	10	—		

**Performance Characteristics**

**Line Regulation vs. Junction Temperature**

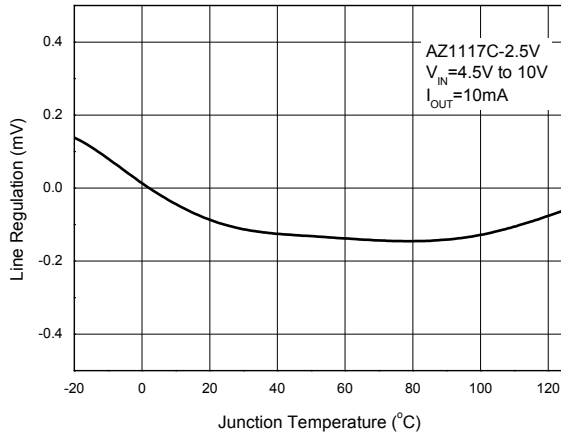

**Load Regulation vs. Junction Temperature**

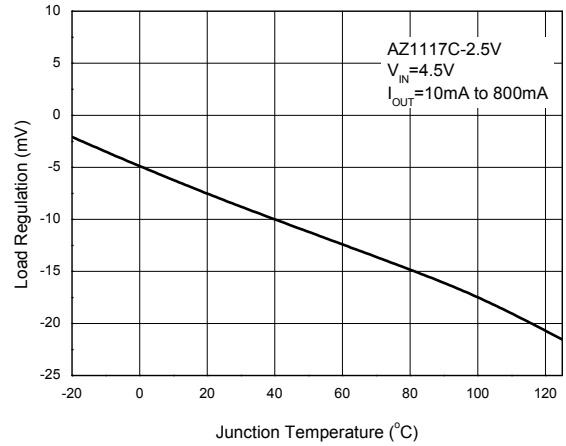

**Reference Voltage vs. Junction Temperature**

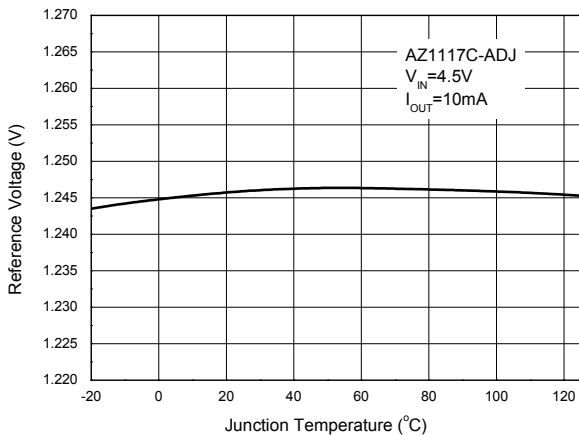

**Output Voltage vs. Junction Temperature**

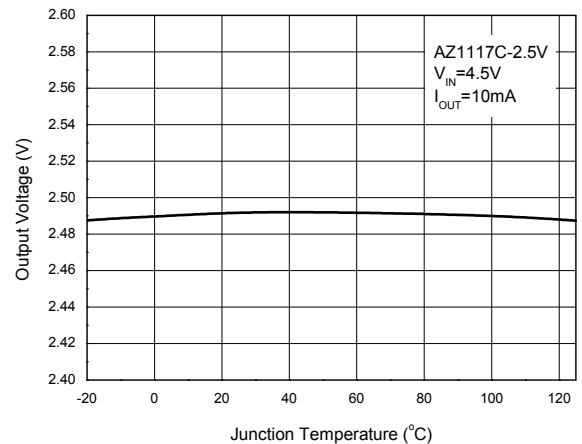

**Minimum Load Current vs. Junction Temperature**

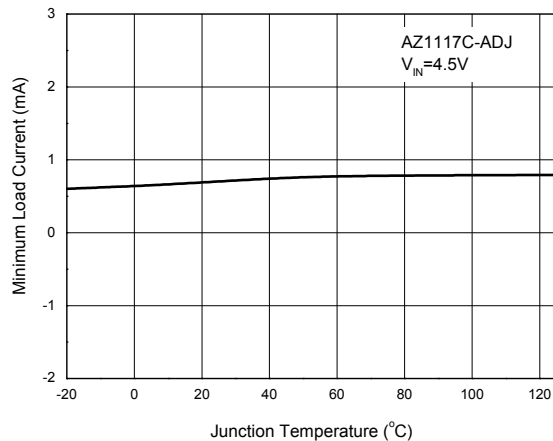

**Adjust Pin Current vs. Junction Temperature**

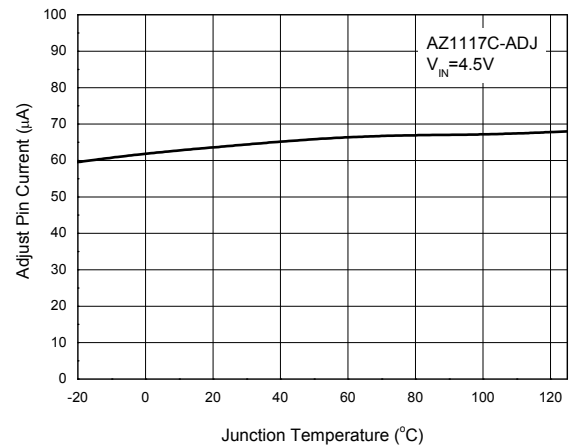



**Performance Characteristics (Cont.)**

**Dropout Voltage vs. Output Current**

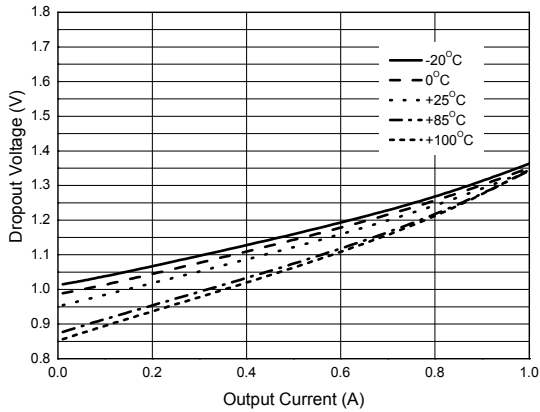

**Power Dissipation vs. Case Temperature**

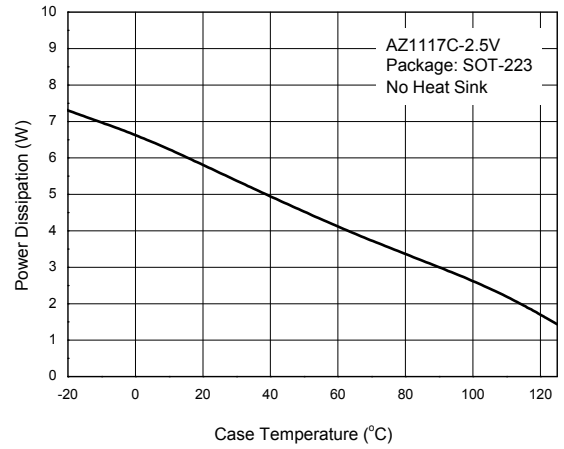

**Line Transient Response**

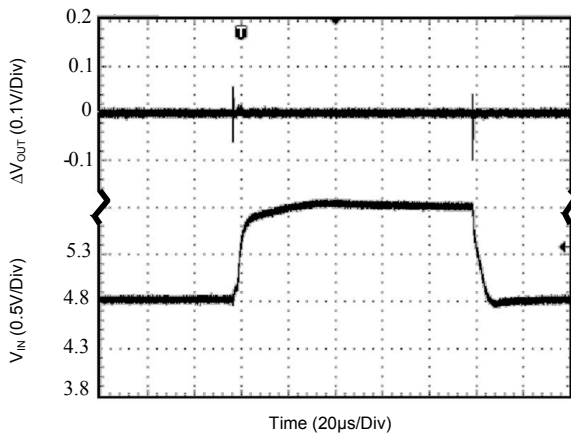

**Load Transient Response**

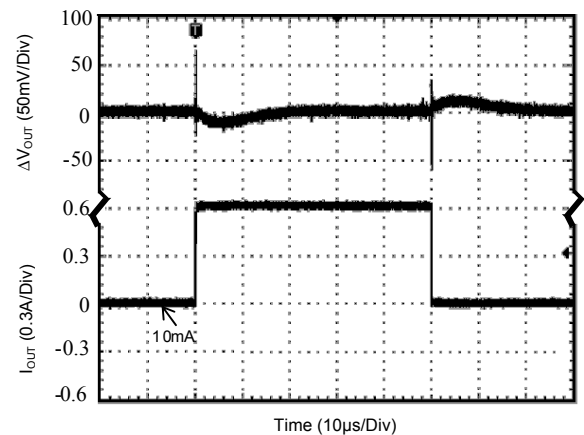

**PSRR vs. Frequency**

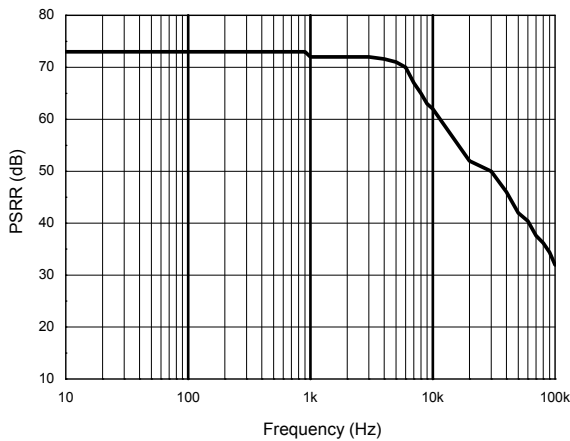

**Current Limit vs. Junction Temperature**

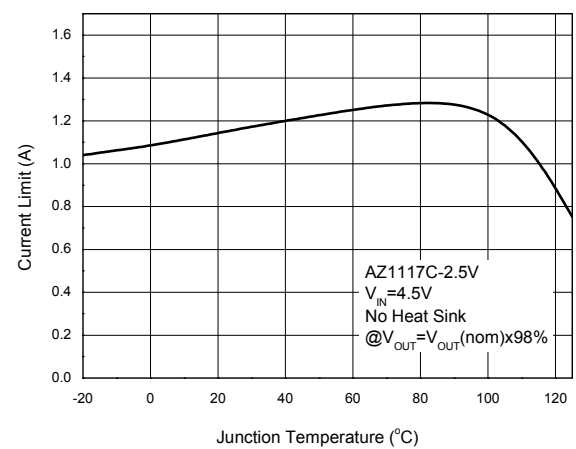

**Performance Characteristics (Cont.)**

**Dropout Voltage vs. Junction Temperature**

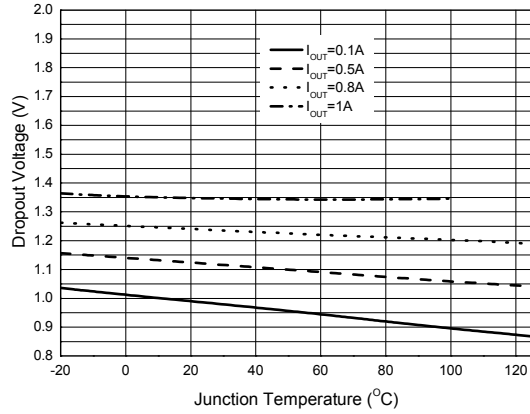

## Ordering Information

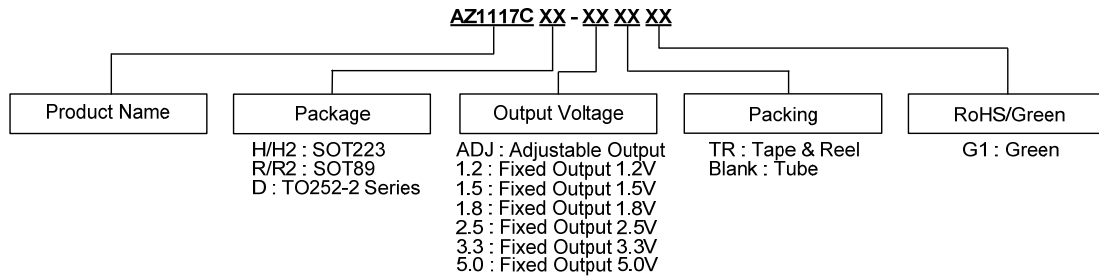

Diodes IC's Pb-free products with "G1" suffix in the part number, are RoHS compliant and green.

Package	Temperature Range	Part Number	Marking ID	Packing
SOT223	-20°C to +125°C	AZ1117CH-ADJTRG1	GH15B	4000/Tape & Reel
		AZ1117CH-1.2TRG1	GH16B	4000/Tape & Reel
		AZ1117CH-1.5TRG1	GH15C	4000/Tape & Reel
		AZ1117CH-1.8TRG1	GH16C	4000/Tape & Reel
		AZ1117CH-2.5TRG1	GH15D	4000/Tape & Reel
		AZ1117CH-3.3TRG1	GH16D	4000/Tape & Reel
		AZ1117CH-5.0TRG1	GH15E	4000/Tape & Reel
SOT223		AZ1117CH2-ADJTRG1	GH14H	4000/Tape & Reel
		AZ1117CH2-1.2TRG1	GH15H	4000/Tape & Reel
		AZ1117CH2-1.5TRG1	GH17H	4000/Tape & Reel
		AZ1117CH2-1.8TRG1	GH27H	4000/Tape & Reel
		AZ1117CH2-2.5TRG1	GH28H	4000/Tape & Reel
		AZ1117CH2-3.3TRG1	GH38H	4000/Tape & Reel
SOT89		AZ1117CR-ADJTRG1	GH13H	4000/Tape & Reel
	AZ1117CR-1.2TRG1	G27N	1000/Tape & Reel	
	AZ1117CR-1.5TRG1	G28J	1000/Tape & Reel	
	AZ1117CR-1.8TRG1	G28K	1000/Tape & Reel	
	AZ1117CR-2.5TRG1	G28L	1000/Tape & Reel	
	AZ1117CR-3.3TRG1	G28M	1000/Tape & Reel	
	AZ1117CR-5.0TRG1	G28N	1000/Tape & Reel	
SOT89	AZ1117CR2-ADJTRG1	G27M	1000/Tape & Reel	
	AZ1117CR2-1.2TRG1	G42O	1000/Tape & Reel	
	AZ1117CR2-1.5TRG1	G43M	1000/Tape & Reel	
	AZ1117CR2-1.8TRG1	G43N	1000/Tape & Reel	
	AZ1117CR2-2.5TRG1	G43O	1000/Tape & Reel	
	AZ1117CR2-3.3TRG1	G70M	1000/Tape & Reel	
	AZ1117CR2-5.0TRG1	G70N	1000/Tape & Reel	
	AZ1117CR2-5.0TRG1	G33N	1000/Tape & Reel	

**Ordering Information** (Cont.)

Package	Temperature Range	Part Number	Marking ID	Packing
TO252-2 Series	-20°C to +125°C	AZ1117CD-ADJG1	AZ1117CD-ADJG1	80/Tube
		AZ1117CD-ADJTRG1	AZ1117CD-ADJG1	2500/Tape & Reel
		AZ1117CD-1.2G1	AZ1117CD-1.2G1	80/Tube
		AZ1117CD-1.2TRG1	AZ1117CD-1.2G1	2500/Tape & Reel
		AZ1117CD-1.5G1	AZ1117CD-1.5G1	80/Tube
		AZ1117CD-1.5TRG1	AZ1117CD-1.5G1	2500/Tape & Reel
		AZ1117CD-1.8G1	AZ1117CD-1.8G1	80/Tube
		AZ1117CD-1.8TRG1	AZ1117CD-1.8G1	2500/Tape & Reel
		AZ1117CD-2.5G1	AZ1117CD-2.5G1	80/Tube
		AZ1117CD-2.5TRG1	AZ1117CD-2.5G1	2500/Tape & Reel
		AZ1117CD-3.3G1	AZ1117CD-3.3G1	80/Tube
		AZ1117CD-3.3TRG1	AZ1117CD-3.3G1	2500/Tape & Reel
		AZ1117CD-5.0G1	AZ1117CD-5.0G1	80/Tube
AZ1117CD-5.0TRG1	AZ1117CD-5.0G1	2500/Tape & Reel		

**Marking Information**

(1) SOT223 Series

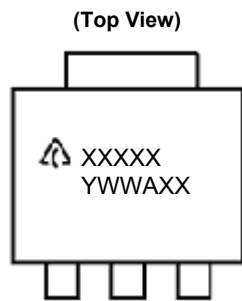

First Line: Logo and Marking ID  
(See Ordering Information)  
Second Line: Date Code  
Y: Year  
WW: Work Week of Molding  
A: Assembly House Code  
XX: 7<sup>th</sup> and 8<sup>th</sup> Digits of Batch Number

(2) TO252-2 Series

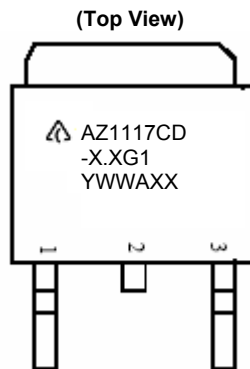

First and Second Lines: Logo and Marking ID  
(See Ordering Information)  
Third Line: Date Code  
Y: Year  
WW: Work Week of Molding  
A: Assembly House Code  
XX: 7<sup>th</sup> and 8<sup>th</sup> Digits of Batch Number

**Marking Information** (Cont.)

(3) SOT89 Series

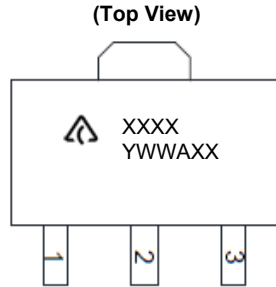

First Line: Logo and Marking ID  
(See Ordering Information)  
Second Line: Date Code  
Y: Year  
WW: Work Week of Molding  
A: Assembly House Code  
XX: 7<sup>th</sup> and 8<sup>th</sup> Digits of Batch Number

**Package Outline Dimensions** (All dimensions in mm (inch).)

(1) Package Type: SOT223

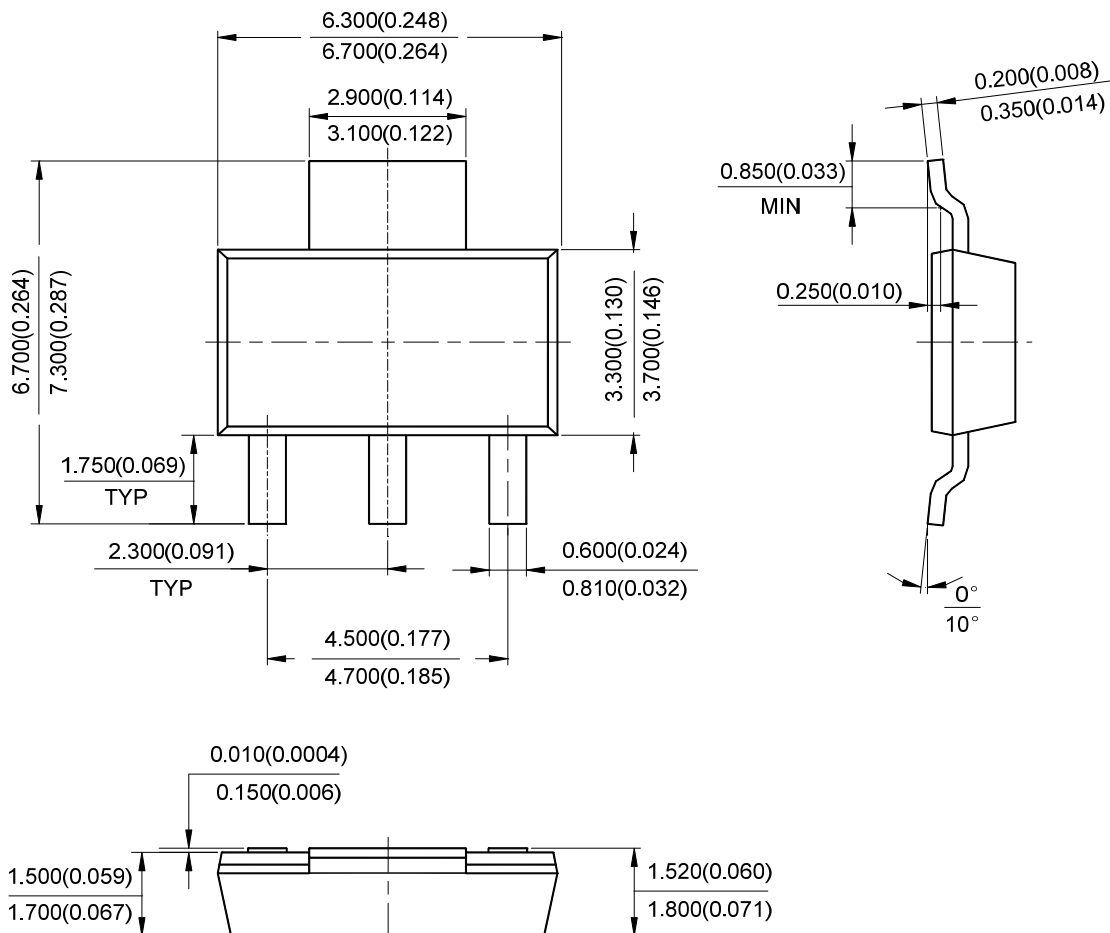

**Package Outline Dimensions** (Cont.) (All dimensions in mm (inch).)

(2) Package Type: SOT89

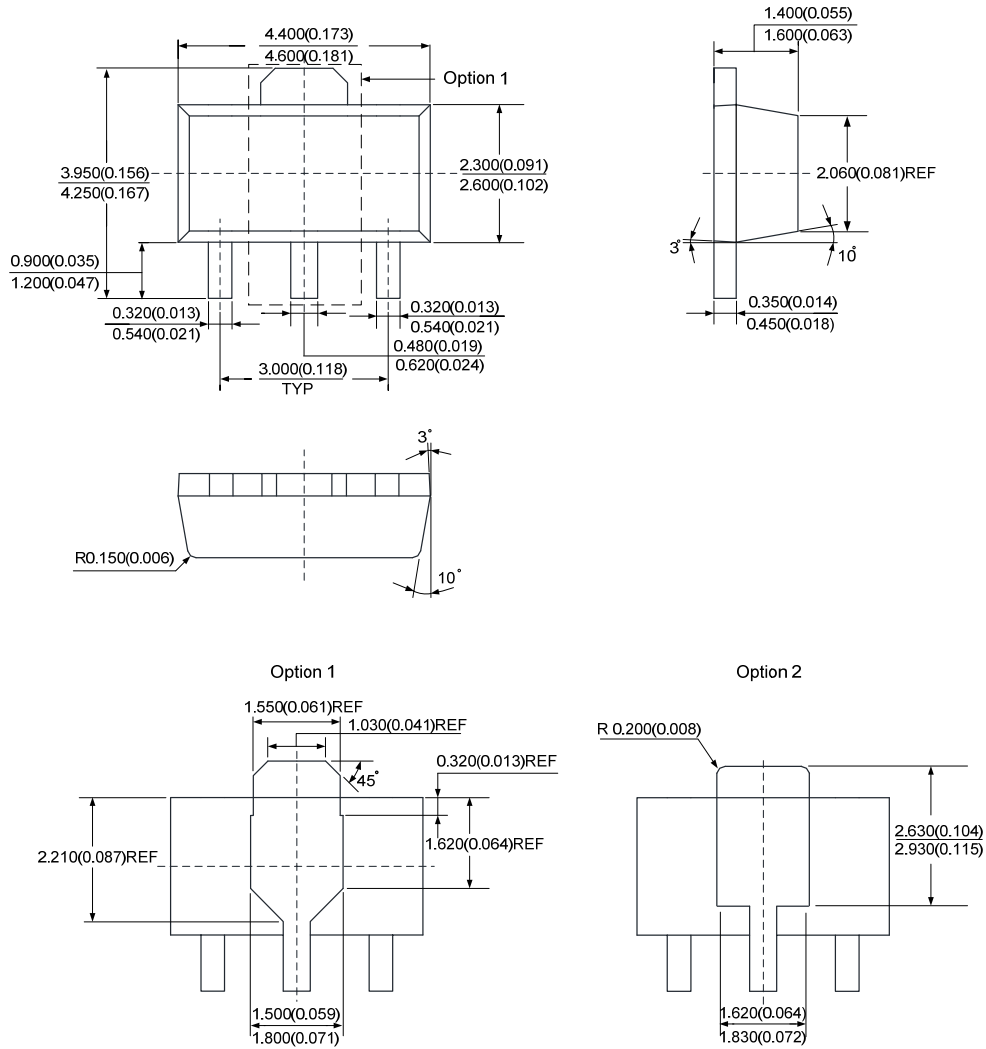

**Package Outline Dimensions** (Cont.) (All dimensions in mm (inch).)

(3) Package Type: TO252-2 (3)

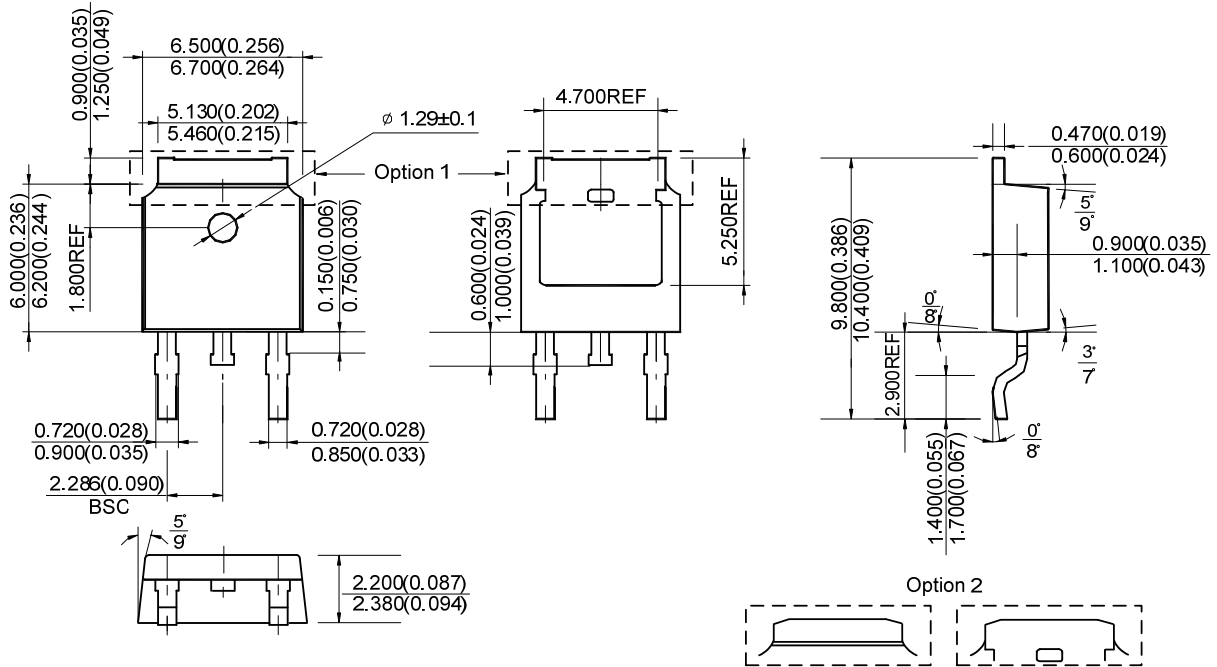

**Package Outline Dimensions** (Cont.) (All dimensions in mm (inch).)

(4) Package Type: TO252-2 (4)

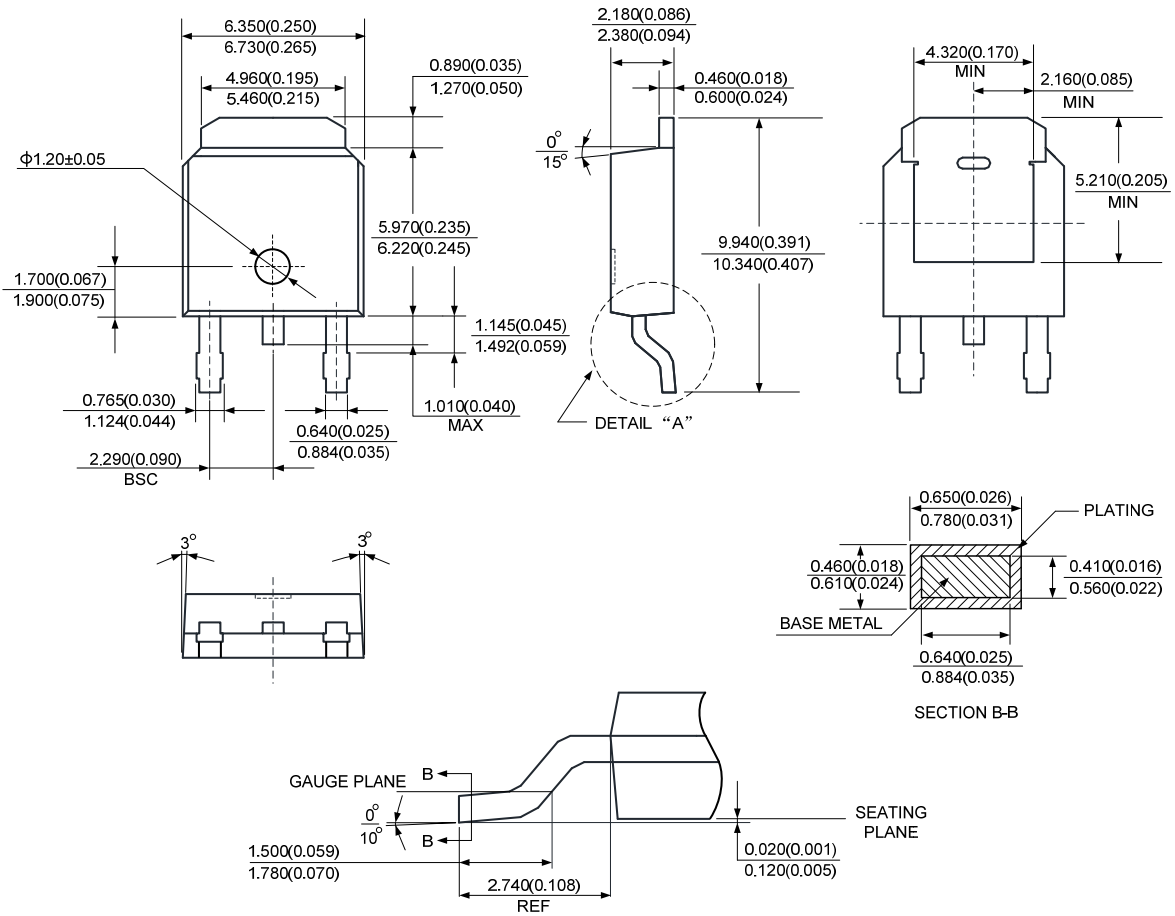



**Package Outline Dimensions** (Cont.) (All dimensions in mm (inch).)

(5) Package Type: TO252-2 (5)

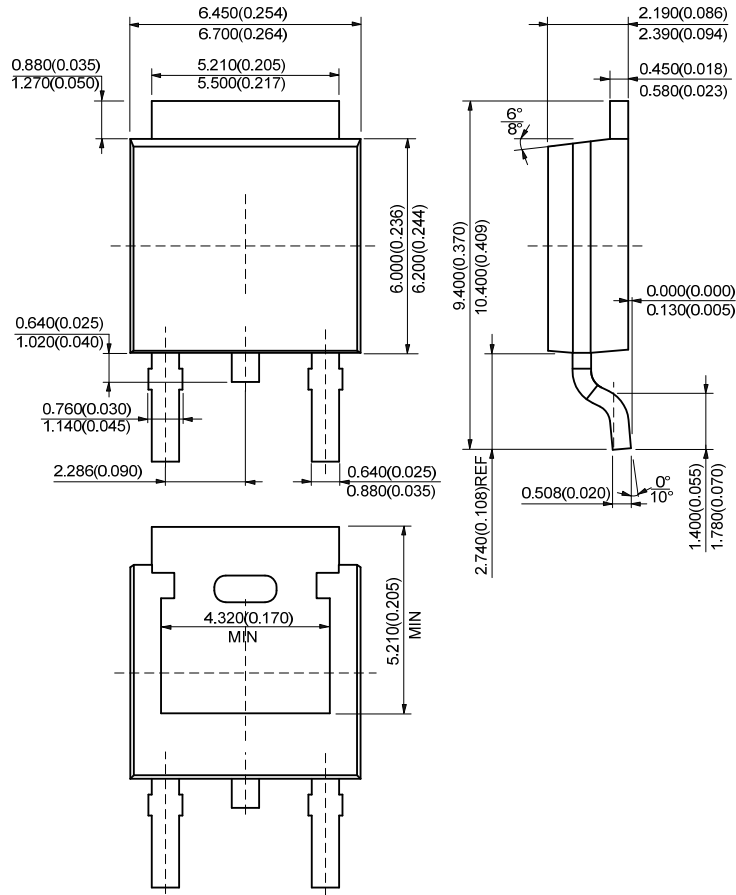

**Suggested Pad Layout**

(1) Package Type: SOT223

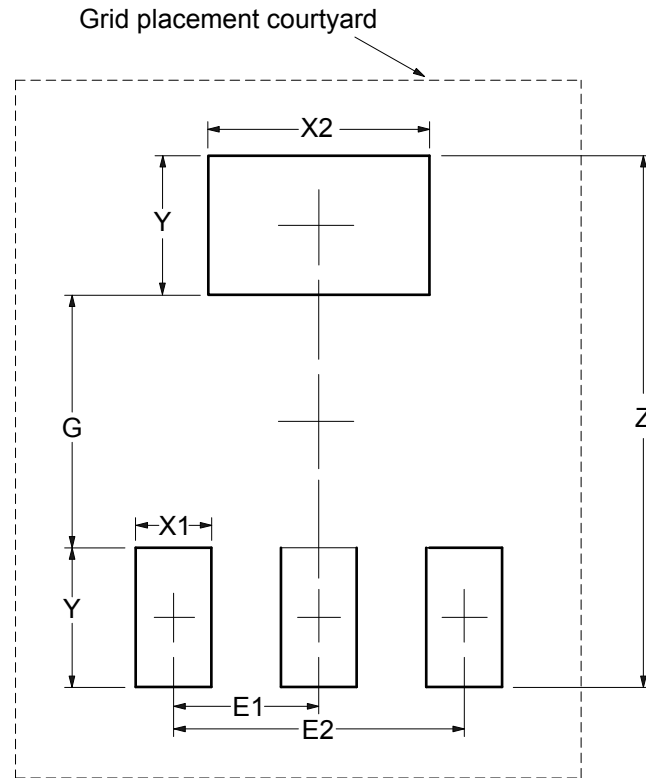

Dimensions	Z (mm)/(inch)	G (mm)/(inch)	X1 (mm)/(inch)	X2 (mm)/(inch)	Y (mm)/(inch)	E1 (mm)/(inch)	E2 (mm)/(inch)
Value	8.400/0.331	4.000/0.157	1.200/0.047	3.500/0.138	2.200/0.087	2.300/0.091	4.600/0.181

**Suggested Pad Layout (Cont.)**

(2) Package Type: SOT89

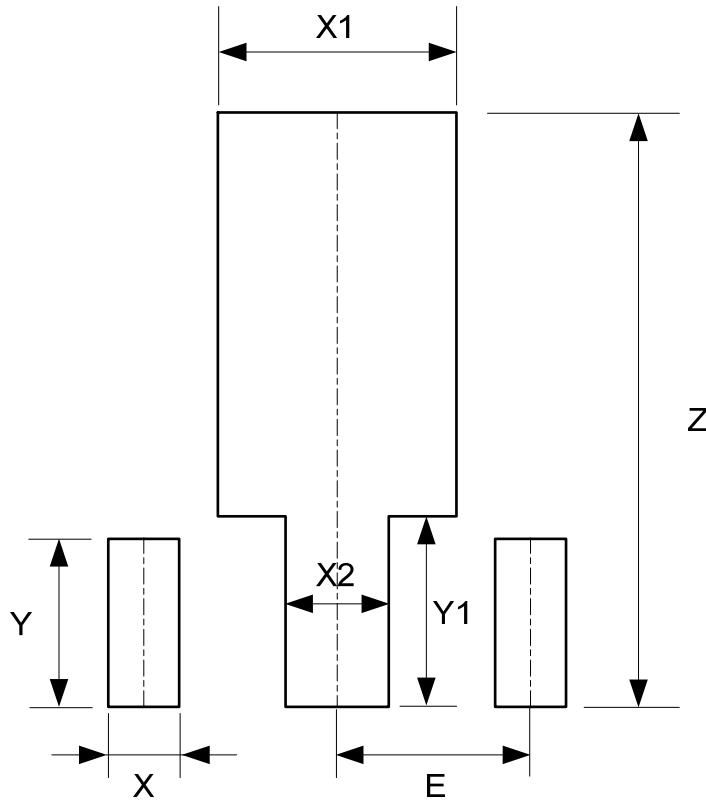

Dimensions	Z (mm)/(inch)	X (mm)/(inch)	X1 (mm)/(inch)	X2 (mm)/(inch)	Y (mm)/(inch)	Y1 (mm)/(inch)	E (mm)/(inch)
Value	4.600/0.181	0.550/0.022	1.850/0.073	0.800/0.031	1.300/0.051	1.475/0.058	1.500/0.059

**Suggested Pad Layout** (Cont.)

(3) Package Type: TO252-2 (3)

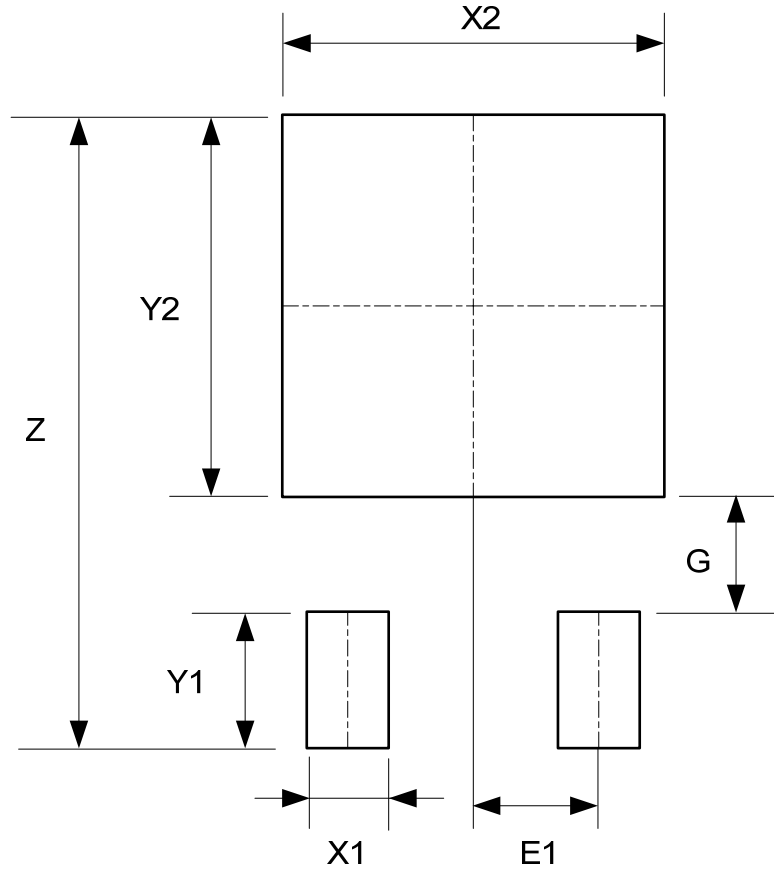

Dimensions	Z (mm)/(inch)	X1 (mm)/(inch)	X2=Y2 (mm)/(inch)	Y1 (mm)/(inch)	G (mm)/(inch)	E1 (mm)/(inch)
Value	11.600/0.457	1.500/0.059	7.000/0.276	2.500/0.098	2.100/0.083	2.300/0.091

**Suggested Pad Layout** (Cont.)

(4) Package Type: TO252-2 (4)

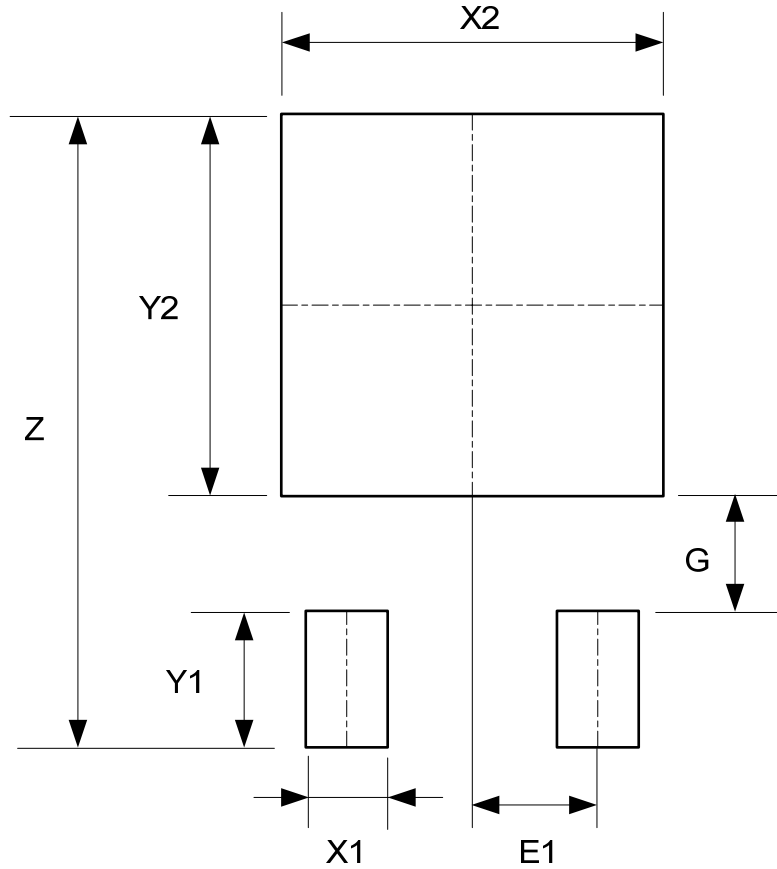

Dimensions	Z (mm)/(inch)	X1 (mm)/(inch)	X2=Y2 (mm)/(inch)	Y1 (mm)/(inch)	G (mm)/(inch)	E1 (mm)/(inch)
Value	11.600/0.457	1.500/0.059	7.000/0.276	2.500/0.098	2.100/0.083	2.300/0.091

**Suggested Pad Layout** (Cont.)

(5) Package Type: TO252-2 (5)

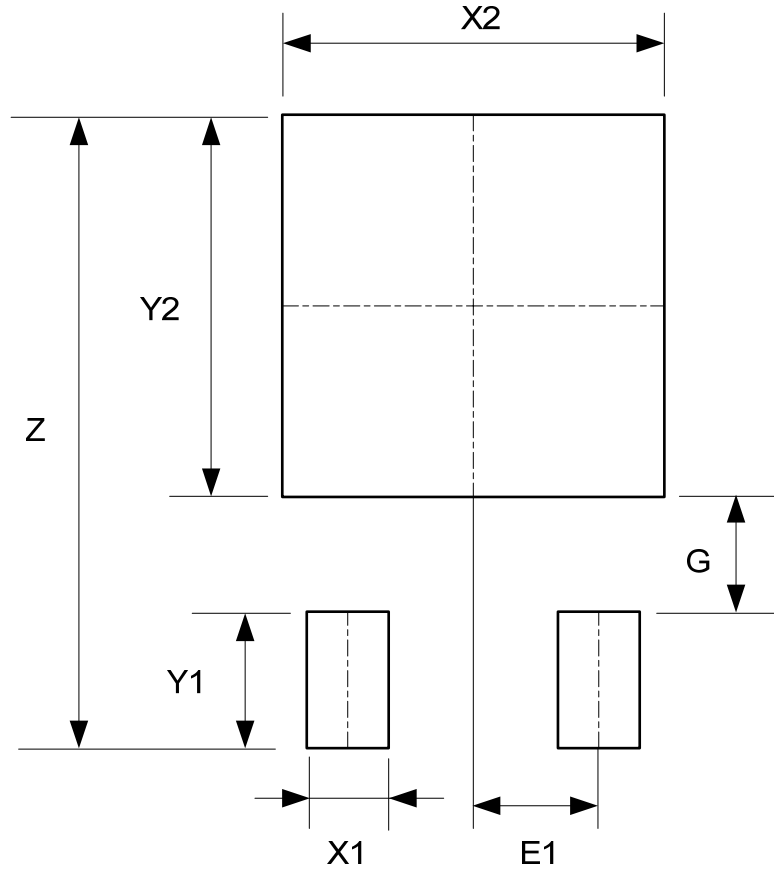

Dimensions	Z (mm)/(inch)	X1 (mm)/(inch)	X2=Y2 (mm)/(inch)	Y1 (mm)/(inch)	G (mm)/(inch)	E1 (mm)/(inch)
Value	11.600/0.457	1.500/0.059	7.000/0.276	2.500/0.098	2.100/0.083	2.300/0.091

**IMPORTANT NOTICE**

DIODES INCORPORATED MAKES NO WARRANTY OF ANY KIND, EXPRESS OR IMPLIED, WITH REGARDS TO THIS DOCUMENT, INCLUDING, BUT NOT LIMITED TO, THE IMPLIED WARRANTIES OF MERCHANTABILITY AND FITNESS FOR A PARTICULAR PURPOSE (AND THEIR EQUIVALENTS UNDER THE LAWS OF ANY JURISDICTION).

Diodes Incorporated and its subsidiaries reserve the right to make modifications, enhancements, improvements, corrections or other changes without further notice to this document and any product described herein. Diodes Incorporated does not assume any liability arising out of the application or use of this document or any product described herein; neither does Diodes Incorporated convey any license under its patent or trademark rights, nor the rights of others. Any Customer or user of this document or products described herein in such applications shall assume all risks of such use and will agree to hold Diodes Incorporated and all the companies whose products are represented on Diodes Incorporated website, harmless against all damages.

Diodes Incorporated does not warrant or accept any liability whatsoever in respect of any products purchased through unauthorized sales channel. Should Customers purchase or use Diodes Incorporated products for any unintended or unauthorized application, Customers shall indemnify and hold Diodes Incorporated and its representatives harmless against all claims, damages, expenses, and attorney fees arising out of, directly or indirectly, any claim of personal injury or death associated with such unintended or unauthorized application.

Products described herein may be covered by one or more United States, international or foreign patents pending. Product names and markings noted herein may also be covered by one or more United States, international or foreign trademarks.

This document is written in English but may be translated into multiple languages for reference. Only the English version of this document is the final and determinative format released by Diodes Incorporated.

**LIFE SUPPORT**

Diodes Incorporated products are specifically not authorized for use as critical components in life support devices or systems without the express written approval of the Chief Executive Officer of Diodes Incorporated. As used herein:

A. Life support devices or systems are devices or systems which:

1. are intended to implant into the body, or
2. support or sustain life and whose failure to perform when properly used in accordance with instructions for use provided in the labeling can be reasonably expected to result in significant injury to the user.

B. A critical component is any component in a life support device or system whose failure to perform can be reasonably expected to cause the failure of the life support device or to affect its safety or effectiveness.

Customers represent that they have all necessary expertise in the safety and regulatory ramifications of their life support devices or systems, and acknowledge and agree that they are solely responsible for all legal, regulatory and safety-related requirements concerning their products and any use of Diodes Incorporated products in such safety-critical, life support devices or systems, notwithstanding any devices- or systems-related information or support that may be provided by Diodes Incorporated. Further, Customers must fully indemnify Diodes Incorporated and its representatives against any damages arising out of the use of Diodes Incorporated products in such safety-critical, life support devices or systems.

Copyright © 2014, Diodes Incorporated

[www.diodes.com](http://www.diodes.com)

# Mouser Electronics

Authorized Distributor

Click to View Pricing, Inventory, Delivery & Lifecycle Information:

## Diodes Incorporated:

[AZ1117CD-2.5TRG1](#) [AZ1117CH-1.5TRG1](#) [AZ1117CH-5.0TRG1](#) [AZ1117CD-ADJTRG1](#) [AZ1117CH-2.5TRG1](#)  
[AZ1117CR-3.3TRG1](#) [AZ1117CD-3.3TRG1](#) [AZ1117CH-1.8TRG1](#) [AZ1117CH-ADJTRG1](#) [AZ1117CD-1.2TRG1](#)  
[AZ1117CH-1.2TRG1](#) [AZ1117CH-3.3TRG1](#) [AZ1117CR-ADJTRG1](#) [AZ1117CD-5.0TRG1](#) [AZ1117CD-1.8TRG1](#)  
[AZ1117CR2-3.3TRG1](#) [AZ1117CR-1.2TRG1](#) [AZ1117CD-1.5TRG1](#) [AZ1117CH2-3.3TRG1](#) [AZ1117CR2-5.0TRG1](#)  
[AZ1117CR2-ADJTRG1](#)