

# CM1624

## EMI Filter for T-Flash / MicroSD Interfaces

### Description

The CM1624 is a combination EMI filter and line termination device with integrated TVS diodes for use on Multimedia Card interfaces. This state-of-the-art device utilizes solid-state, silicon-avalanche technology for superior clamping performance and DC electrical characteristics. The CM1624 has been optimized for protection of T-Flash/MicroSD interfaces in cellular phones and other portable electronics.

The CM1624 consists of six circuits that includes series impedance matching resistors and pull-up resistors as required by the SD specification. TVS diodes are included on each line for ESD protection. An additional TVS diode connection is included for protection of the voltage (Vcc) bus. Termination resistor value of 40  $\Omega$  is provided on the SDData0, SDData1, SDData2, SDData3, CMD, and CLK lines.

Pull-up resistors of 25 k $\Omega$  are included on the SDData0, SDData1, SDData2, SDData3 and CMD lines, as well. These may be configured for devices operating in SD or SPI mode. The TVS diodes provide effective suppression of ESD voltages in excess of  $\pm 15$  kV (contact discharge) per IEC 61000-4-2, level 4. The CM1624 is in a 16-pin, RoHS/WEEE compliant, UDFN 16-pin package. It measures 3.30 x 1.35 x 0.50 mm. The leads are spaced at a pitch of 0.4 mm and are finished with lead-free NiPd.

### Features

- Bidirectional EMI/RFI Filtering and Line Termination with Integrated ESD Protection
- Provides ESD Protection to IEC61000-4-2:  $\pm 15$  kV Contact Discharge
- TVS Working Voltage: 5 V
- Termination Resistors: 40  $\Omega$
- Pull-up Resistors: 25 k $\Omega$
- Typical Capacitance per Line: 12 pF ( $V_{IN} = 2.5$  V)
- Protection and Termination for Six Lines + Vcc
- Solid-state Technology

### Applications

- T-Flash / MicroSD Interfaces
- MMC Interfaces
- CDMA, GSM, 3G Cell Phones

### Mechanical Characteristics

- 0.40 mm, uDFN 16-pin Package
- Nominal Dimensions: 3.30 x 1.35 x 0.50 mm
- Pitch: 0.4 mm
- Pin-lead Finish: NiPd
- RoHS/WEEE Compliance, Lead-free Finish



ON Semiconductor®

<http://onsemi.com>

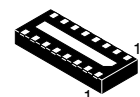

UDFN16  
DE SUFFIX  
CASE 517BE

### MARKING DIAGRAM

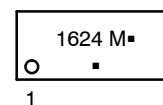

- 1624 = Specific Device Code  
M = Single Character Date Code  
■ = Pb-Free Package

(\*Note: Microdot may be in either location)

### PINOUT DIAGRAM

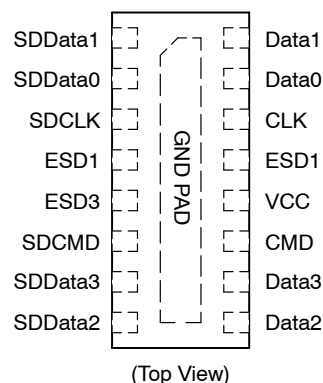

### ORDERING INFORMATION

Device	Package	Shipping†
CM1624-08DE	UDFN16 (Pb-Free)	3000/Tape & Reel

†For information on tape and reel specifications, including part orientation and tape sizes, please refer to our Tape and Reel Packaging Specification Brochure, BRD8011/D.

# CM1624

## ELECTRICAL SCHEMATIC

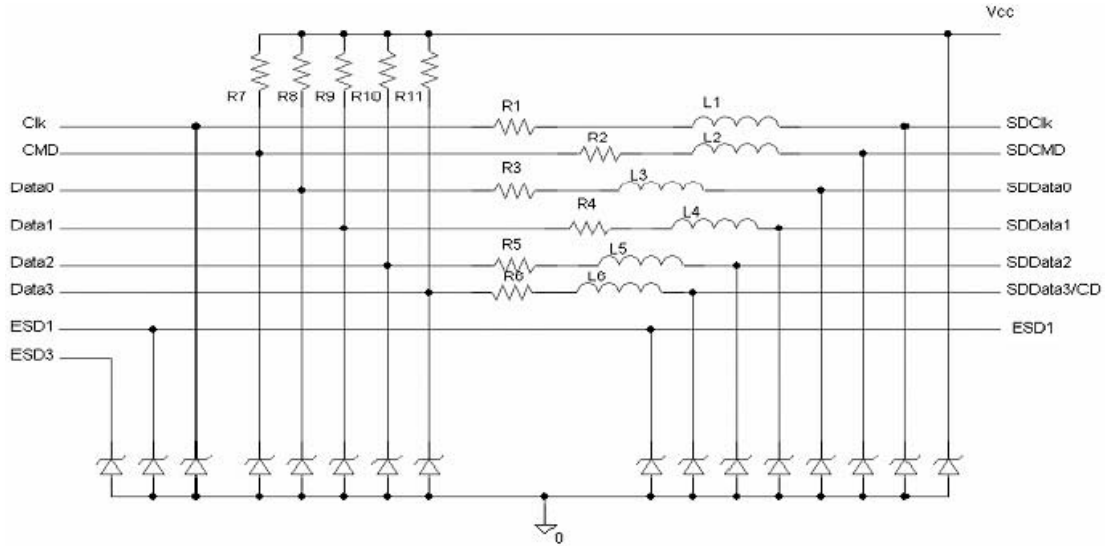

**Table 1. PIN DESCRIPTIONS**

Pin	Name	Description
1	SDData1	Data line #1 input/output with pull-up resistor
2	SDData0	Data line #0 input/output with pull-up resistor
3	SDCLK	Clock line Input/Output
4	ESD1	Single ESD
5	ESD3	Single ESD
6	SDCMD	Command Line Input/Output
7	SDData3	Data line #3 input/output with pull-up resistor
8	SDData2	Data line #2 input/output with pull-up resistor
9	Data2	Data line #2 input/output with pull-up resistor
10	Data3	Data line #3 input/output with pull-up resistor
11	CMD	Command Line Input/Output
12	VCC	Power Supply ESD Protection
13	ESD1	Single ESD
14	CLK	Clock line Input/Output
15	Data0	Data line #0 input/output with pull-up resistor
16	Data1	Data line #1 input/output with pull-up resistor
GND PAD	GND	Ground return to shield

# CM1624

## SPECIFICATIONS

**Table 2. ABSOLUTE MAXIMUM RATINGS**

Parameter	Rating	Units
Operating Temperature Range	-40 to +85	°C
Storage Temperature Range	-55 to +150	°C

Stresses exceeding Maximum Ratings may damage the device. Maximum Ratings are stress ratings only. Functional operation above the Recommended Operating Conditions is not implied. Extended exposure to stresses above the Recommended Operating Conditions may affect device reliability.

**Table 3. ELECTRICAL OPERATING CHARACTERISTICS** (Note 1)

Symbol	Parameter	Conditions	Min	Typ	Max	Units
R <sub>CH</sub>	Channel Resistance (R1 to R6)		34	40	46	Ω
L <sub>CH</sub>	Channel Inductance			20		nH
C	Capacitance per Channel	V <sub>IN</sub> = 0 V; 1 MHz; 30 mV <sub>RMS</sub>	16	20	24	pF
		V <sub>IN</sub> = 2.5 V; 1 MHz; 30 mV <sub>RMS</sub> ; (Note 2)		12		pF
R <sub>UP</sub>	Pull-up Resistance (R7 to R11)		21	25	29	kΩ
I <sub>LEAK</sub>	Diode Leakage Current per Channel	V <sub>IN</sub> = 3 V		0.1	0.5	μA
V <sub>SIG</sub>	Signal Clamp Voltage					V
	Positive Clamp Negative Clamp	I <sub>LOAD</sub> = 10 mA I <sub>LOAD</sub> = -10 mA	5.6 -1.5	6.8 -0.8	9.0 -0.4	
V <sub>ESD</sub>	ESD Protection – Peak Discharge Voltage at any channel input, in system:					kV
	a) Contact discharge per IEC 61000-4-2 Standard and b) Air discharge per IEC 61000-4-2 Standard	(Note 2) (Note 2)	±15 ±15			
f <sub>C</sub>	Cut-off frequency Z <sub>SOURCE</sub> = 50 Ω, Z <sub>LOAD</sub> = 50 Ω			300		MHz

1. All parameters specified at T<sub>A</sub> = 25°C unless otherwise noted.
2. This parameter is guaranteed by design and verified by device characterization

# CM1624

## PERFORMANCE INFORMATION

Typical Filter Performance (nominal conditions unless specified otherwise, 50  $\Omega$  Environment)

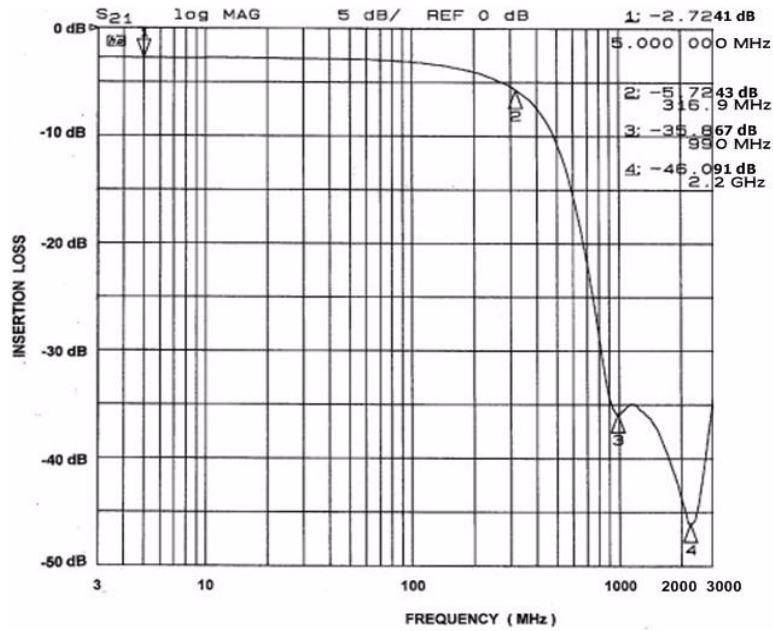

Figure 1. Insertion Loss vs. Frequency (Pins 1 and 16)

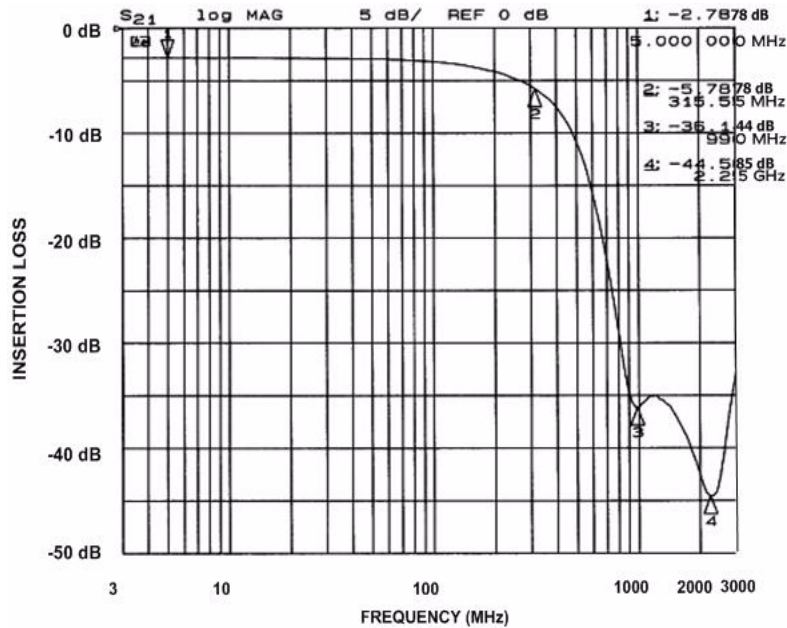

Figure 2. Insertion Loss vs. Frequency (Pins 2 and 15)

# CM1624

## PERFORMANCE INFORMATION (cont'd)

Typical Filter Performance (nominal conditions unless specified otherwise, 50 Ω Environment)

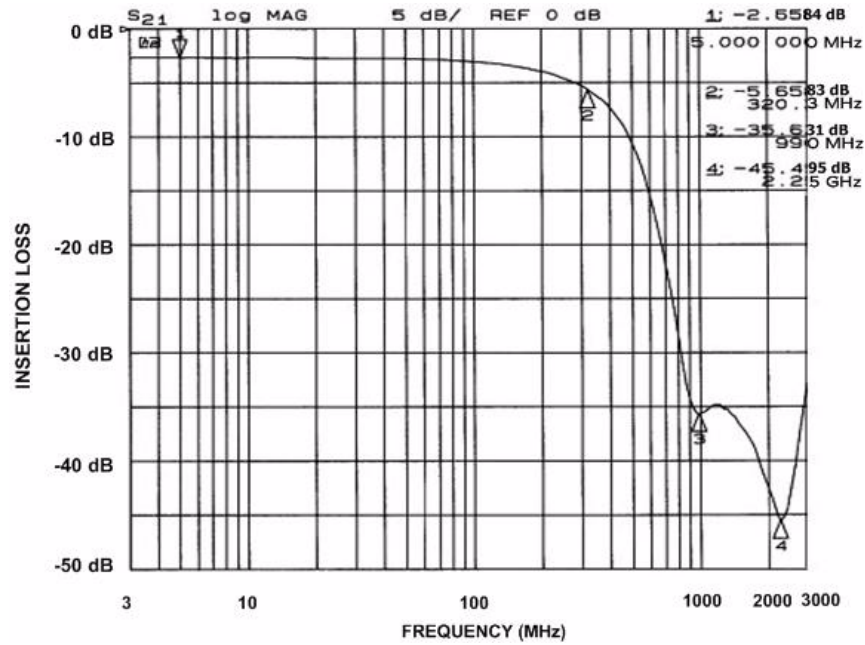

Figure 3. Insertion Loss vs. Frequency (Pins 3 and 14)

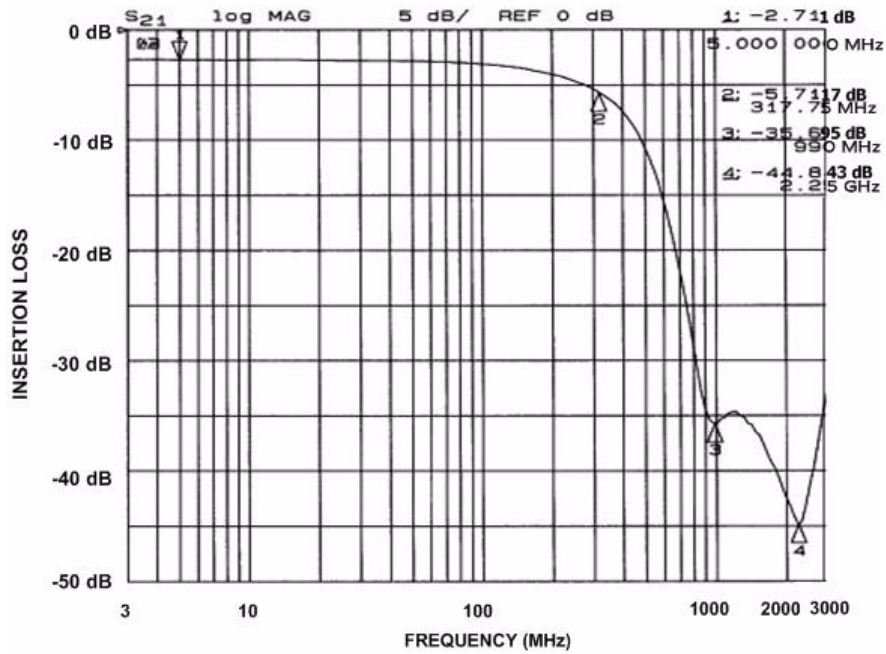

Figure 4. Insertion Loss vs. Frequency (Pins 6 and 11)

# CM1624

## PERFORMANCE INFORMATION (cont'd)

Typical Filter Performance (nominal conditions unless specified otherwise, 50  $\Omega$  Environment)

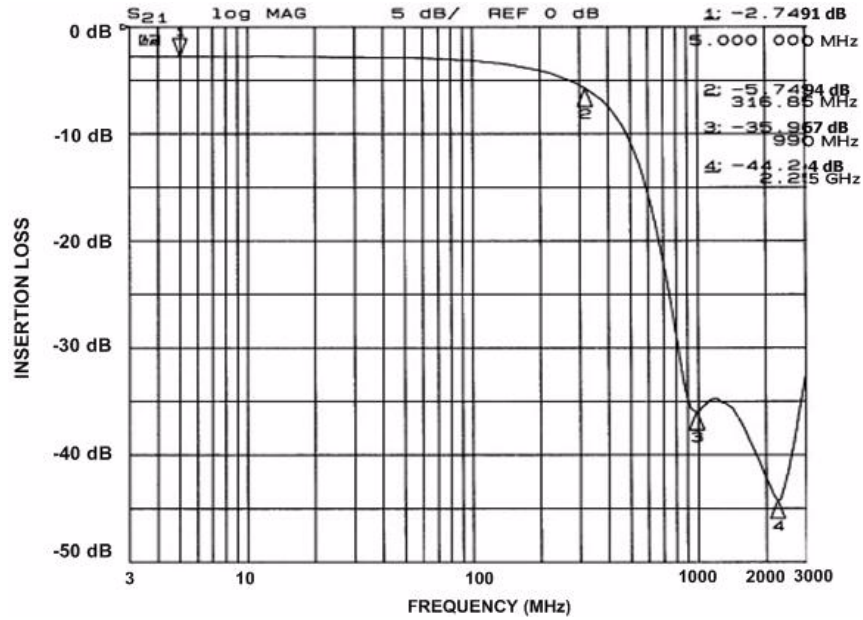

Figure 5. Insertion Loss vs. Frequency (Pins 7 and 10)

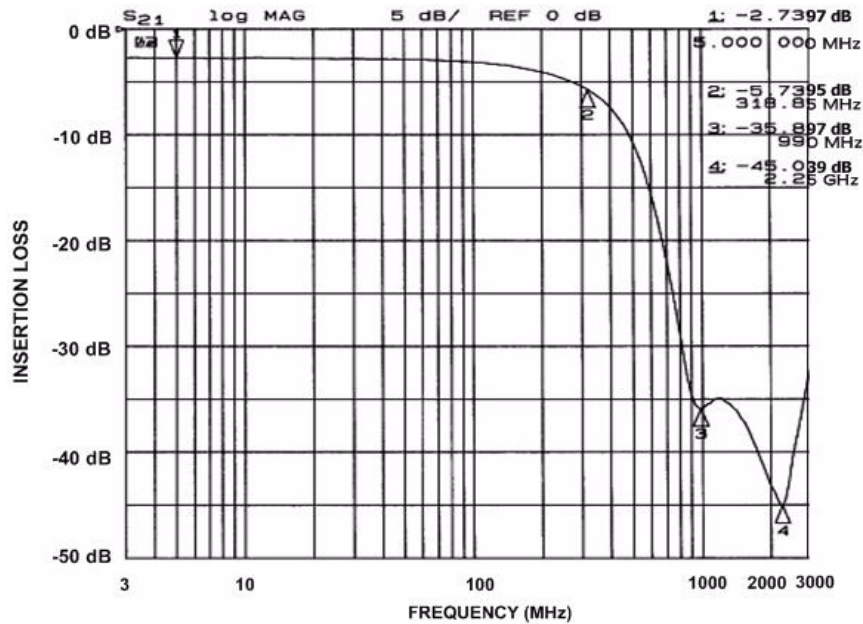
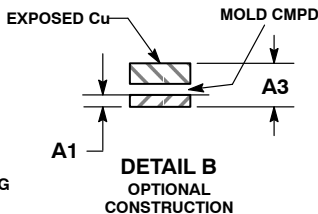
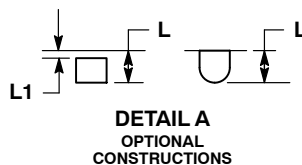
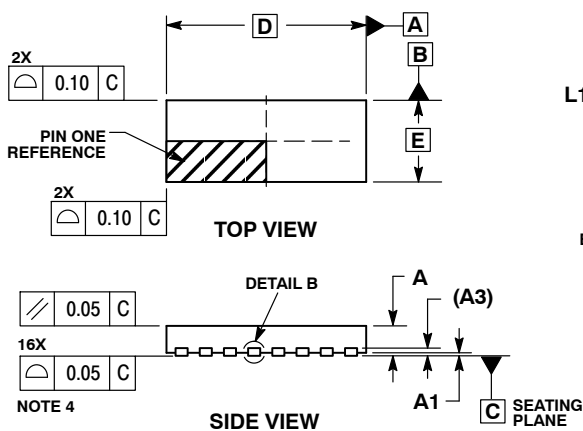

Figure 6. Insertion Loss vs. Frequency (Pins 8 and 9)

# CM1624

## PACKAGE DIMENSIONS

UDFN16, 3.3x1.35, 0.4P  
CASE 517BE-01  
ISSUE O



**NOTES:**

1. DIMENSIONING AND TOLERANCING PER ASME Y14.5M, 1994.
2. CONTROLLING DIMENSION: MILLIMETERS.
3. DIMENSION b APPLIES TO PLATED TERMINAL AND IS MEASURED BETWEEN 0.15 AND 0.25 mm FROM THE TERMINAL TIP.
4. COPLANARITY APPLIES TO THE EXPOSED PAD AS WELL AS THE TERMINALS.

MILLIMETERS		
DIM	MIN	MAX
A	0.45	0.55
A1	0.00	0.05
A3	0.13	REF
b	0.15	0.25
D	3.30	BSC
D2	2.70	2.90
E	1.35	BSC
E2	0.30	0.50
e	0.40	BSC
K	0.15	---
L	0.20	0.30
L1	---	0.05

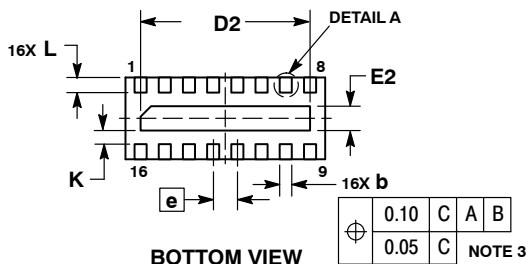

### RECOMMENDED SOLDERING FOOTPRINT\*

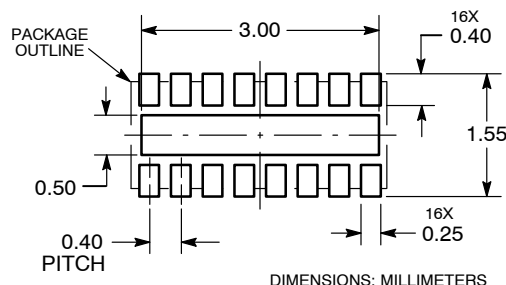

\*For additional information on our Pb-Free strategy and soldering details, please download the ON Semiconductor Soldering and Mounting Techniques Reference Manual, SOLDERRM/D.

ON Semiconductor and are registered trademarks of Semiconductor Components Industries, LLC (SCILLC). SCILLC owns the rights to a number of patents, trademarks, copyrights, trade secrets, and other intellectual property. A listing of SCILLC's product/patent coverage may be accessed at [www.onsemi.com/site/pdf/Patent-Marking.pdf](http://www.onsemi.com/site/pdf/Patent-Marking.pdf). SCILLC reserves the right to make changes without further notice to any products herein. SCILLC makes no warranty, representation or guarantee regarding the suitability of its products for any particular purpose, nor does SCILLC assume any liability arising out of the application or use of any product or circuit, and specifically disclaims any and all liability, including without limitation special, consequential or incidental damages. "Typical" parameters which may be provided in SCILLC data sheets and/or specifications can and do vary in different applications and actual performance may vary over time. All operating parameters, including "Typicals" must be validated for each customer application by customer's technical experts. SCILLC does not convey any license under its patent rights nor the rights of others. SCILLC products are not designed, intended, or authorized for use as components in systems intended for surgical implant into the body, or other applications intended to support or sustain life, or for any other application in which the failure of the SCILLC product could create a situation where personal injury or death may occur. Should Buyer purchase or use SCILLC products for any such unintended or unauthorized application, Buyer shall indemnify and hold SCILLC and its officers, employees, subsidiaries, affiliates, and distributors harmless against all claims, costs, damages, and expenses, and reasonable attorney fees arising out of, directly or indirectly, any claim of personal injury or death associated with such unintended or unauthorized use, even if such claim alleges that SCILLC was negligent regarding the design or manufacture of the part. SCILLC is an Equal Opportunity/Affirmative Action Employer. This literature is subject to all applicable copyright laws and is not for resale in any manner.

### PUBLICATION ORDERING INFORMATION

**LITERATURE FULFILLMENT:**

Literature Distribution Center for ON Semiconductor  
P.O. Box 5163, Denver, Colorado 80217 USA  
Phone: 303-675-2175 or 800-344-3860 Toll Free USA/Canada  
Fax: 303-675-2176 or 800-344-3867 Toll Free USA/Canada  
Email: [orderlit@onsemi.com](mailto:orderlit@onsemi.com)

**N. American Technical Support:** 800-282-9855 Toll Free  
USA/Canada  
**Europe, Middle East and Africa Technical Support:**  
Phone: 421 33 790 2910  
**Japan Customer Focus Center**  
Phone: 81-3-5817-1050

**ON Semiconductor Website:** [www.onsemi.com](http://www.onsemi.com)

**Order Literature:** <http://www.onsemi.com/orderlit>

For additional information, please contact your local Sales Representative

# Mouser Electronics

Authorized Distributor

Click to View Pricing, Inventory, Delivery & Lifecycle Information:

[ON Semiconductor:](#)

[CM1624-08DE](#)