

Features

Regulated Converters

- 2:1 Wide Input Voltage Range
- 1.6kVDC Isolation
- UL Certified
- Efficiency up to 91%
- Six-Sided Continuous Shield
- No Minimum Load Required



RP30-F

30 Watt



2"x1" Package
Single & Dual
Output



Description

The RP30-F series DC/DC converters are designed to meet to UL 60950-1 and to cUL60950-1. This makes them ideal for all telecom and industrial applications where approved safety standards are required. The industry standard 2" x 1" package meets military standards for thermal shock and vibration tolerance.

Selection Guide

Part Number	Input Voltage Range [VDC]	Output Voltage [VDC]	Output Current [mA]	Input ⁽¹⁾ Current [mA]	Efficiency ⁽¹⁾ typ. [%]	Max. Capacitive Load ⁽²⁾ [μF]
RP30-123.3SF ^(3,4)	9-18	3.3	8000	2588	85	20000
RP30-1205SF ^(3,4)	9-18	5	6000	2874	87	14400
RP30-1212SF ^(3,4)	9-18	12	2500	2809	89	3000
RP30-1215SF ^(3,4)	9-18	15	2000	2809	89	2000
RP30-243.3SF ^(3,4)	18-36	3.3	8000	1264	87	20000
RP30-2405SF ^(3,4)	18-36	5	6000	1389	90	14400
RP30-2412SF ^(3,4)	18-36	12	2500	1374	91	3000
RP30-2415SF ^(3,4)	18-36	15	2000	1374	91	2000
RP30-483.3SF ^(3,4)	36-75	3.3	8000	632	87	20000
RP30-4805SF ^(3,4)	36-75	5	6000	694	90	14400
RP30-4812SF ^(3,4)	36-75	12	2500	687	91	3000
RP30-4815SF ^(3,4)	36-75	15	2000	687	91	2000
RP30-1205DF ^(3,4)	9-18	±5	±3000	2874	87	±3000
RP30-1212DF ^(3,4)	9-18	±12	±1250	2874	87	±2000
RP30-1215DF ^(3,4)	9-18	±15	±1000	2874	87	±1300
RP30-2405DF ^(3,4)	18-36	±5	±3000	1389	90	±3000
RP30-2412DF ^(3,4)	18-36	±12	±1250	1404	89	±2000
RP30-2415DF ^(3,4)	18-36	±15	±1000	1389	90	±1300
RP30-4805DF ^(3,4)	36-75	±5	±3000	694	90	±3000
RP30-4812DF ^(3,4)	36-75	±12	±1250	710	88	±2000
RP30-4815DF ^(3,4)	36-75	±15	±1000	702	89	±1300

Notes:

- Note1: Typical value at nominal input voltage and full load.
 Note2: Test by minimum Vin and constant resistor load.



Model Numbering

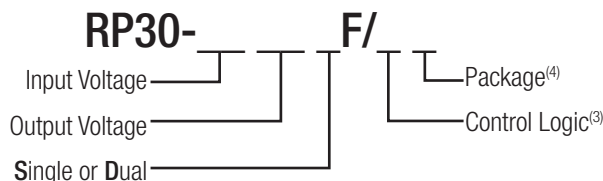

Ordering Examples

- RP30-2405SF = 24V Input, 5V Output, Positive Logic CTRL pin fitted
 RP30-4812DF/N-HC = 48V Input, ±12V Output, Negative Logic CTRL pin fitted, Heat-sink fitted

Notes:

- Note3: no suffix for CTRL function with Positive Logic (1=ON, 0=OFF)
 add "N" for CTRL function with Negative Logic (0=ON, 1=OFF)
 Note4: add suffix -HC for premounted Heat-sink and clips

UL60950-1 Certified

Specifications measured at Ta = 25°C, nominal input voltage, full load otherwise noted

BASIC CHARACTERISTICS

Parameter	Condition	Min.	Typ.	Max.
Input Voltage Range	nom. Vin = 12V nom. Vin = 24V nom. Vin = 48V	9VDC 18VDC 36VDC	12VDC 24VDC 48VDC	18VDC 36VDC 75VDC
Under Voltage Lockout (UVLO)	Vin = 12V DC-DC ON DC-DC OFF		8VDC	9VDC
	Vin = 24V DC-DC ON DC-DC OFF		16VDC	18VDC
	Vin = 48V DC-DC ON DC-DC OFF		32VDC	36VDC
Input Filter				Pi-Type
Input Reflected Ripple Current ⁽⁵⁾	nominal Vin and full load		20mA _{p-p}	
Input Surge Voltage	Vin = 12V, 100ms max. Vin = 24V, 100ms max. Vin = 48V, 100ms max.			25VDC 50VDC 100VDC
Start-up time	Power up Remote ON/OFF		30ms 30ms	
Operating Frequency Range		387kHz	430kHz	473kHz
Minimum Load		0%		
Ripple and Noise	measured by 20Mhz bandwidth with a 1µF/50V MLCC	3.3V _{out} , 5V _{out} 12V _{out} , 15V _{out}		100mV _{p-p} 150mV _{p-p}
Remote ON/OFF ⁽⁶⁾	Positive Logic	DC-DC ON DC-DC OFF		Open or 3.0V < Vr < 12V Short or 0V < Vr < 1.2V
	Negative Logic	DC-DC ON DC-DC OFF		Short or 0V < Vr < 1.2V Open or 3.0V < Vr < 12V
Input current of Remote pin (CTRL)		DC-DC OFF		3mA
		DC-DC ON	-0.5mA	0.5mA

Notes:

Note5: Simulated source impedance of 12µH. 12µH inductor in series with +Vin.

Note6: The ON/OFF control function can be positive or negative logic. The pin voltage is referenced to -Vin pin.

RP30-1205SF

Efficiency vs. Output Current

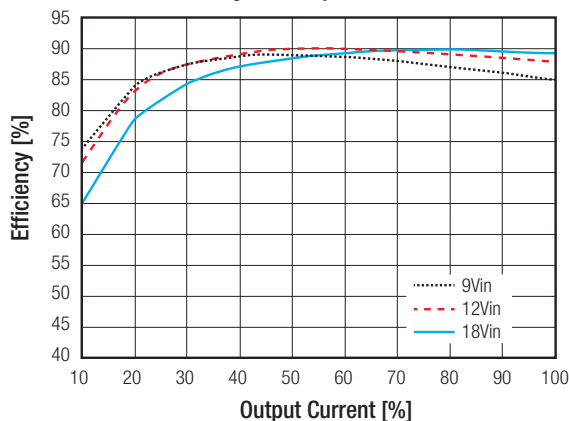

Efficiency vs. Input Voltage

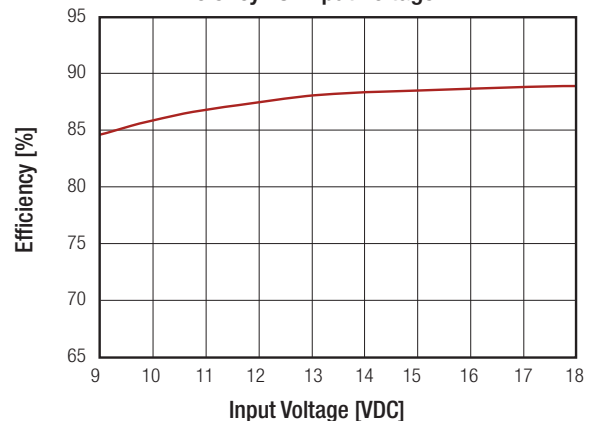

continued on next page

Specifications measured at Ta = 25°C, nominal input voltage, full load otherwise noted

RP30-2405SF

Efficiency vs. Output Current

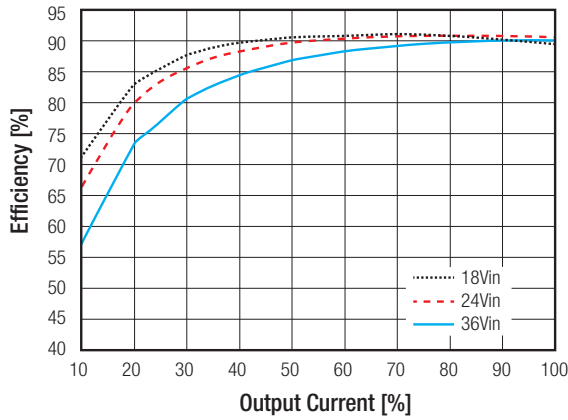

Efficiency vs. Input Voltage

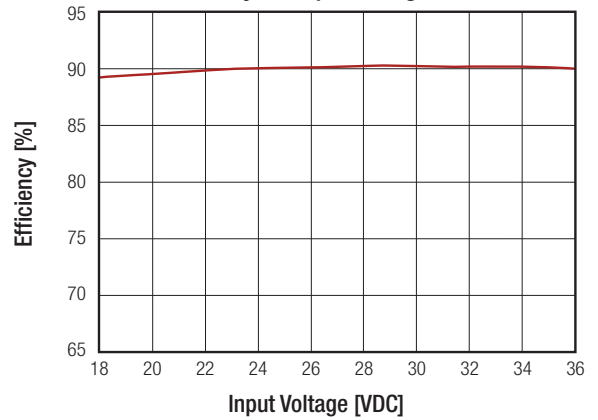

RP30-4805SF

Efficiency vs. Output Current

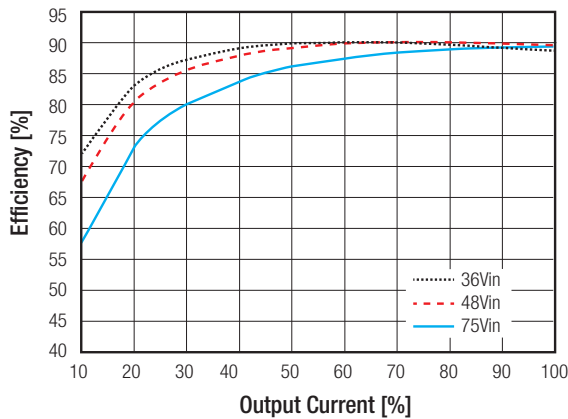

Efficiency vs. Input Voltage

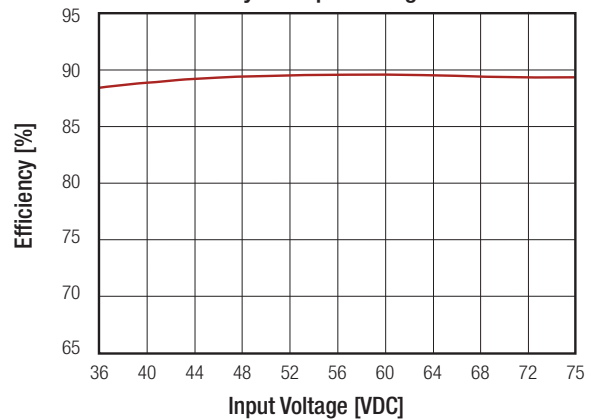

REGULATIONS

Parameter	Condition		Value
Output Voltage Accuracy			±1%
Voltage Adjustability	Single Output		±10%
Line Voltage Regulation	low line to high line at full load		±0.2%
Load Voltage Regulation	no load to full load	Single Dual	±0.5% ±1.0%
Cross Regulation	asymmetrical 25% <-> 100% load		±5%
Transient Response recovery time	25% load step change		250µs

External Output Trimming

Output Voltage Trimming

Single output Powerline converters offer the feature of trimming the output voltage over a certain range around the nominal value by using external trim resistors. No general equation can be given for calculating the trim resistors, but the following trimtables give typical values for choosing these trimming resistors. If voltages between the given trim points are required, extrapolate between the two nearest given values to work out the resistor required or use a variable resistor to set the output voltage.

Output can be externally trimmed by using the method shown below.

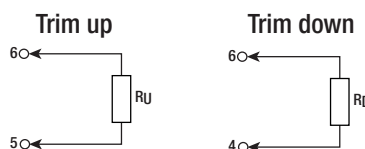

continued on next page

Specifications measured at Ta = 25°C, nominal input voltage, full load otherwise noted

RP30-xx3.3SF											
Trim up	1	2	3	4	5	6	7	8	9	10	%
Vout =	3.333	3.366	3.399	3.432	3.465	3.498	3.531	3.564	3.597	3.63	Volts
R _l =	57.93	26.16	15.58	10.28	7.11	4.99	3.48	2.34	1.46	0.75	kOhms
Trim down	1	2	3	4	5	6	7	8	9	10	%
Vout =	3.267	3.234	3.201	3.168	3.135	3.102	3.069	3.036	3.003	2.97	Volts
R _l =	69.47	31.23	18.49	12.12	8.29	5.74	3.92	2.56	1.50	0.65	kOhms
RP30-xx05SF											
Trim up	1	2	3	4	5	6	7	8	9	10	%
Vout =	5.05	5.10	5.15	5.20	5.25	5.30	5.35	5.4	5.45	5.50	Volts
R _l =	36.57	16.58	9.92	6.58	4.59	3.25	2.30	1.59	1.03	0.59	kOhms
Trim down	1	2	3	4	5	6	7	8	9	10	%
Vout =	4.95	4.90	4.85	4.80	4.75	4.70	4.65	4.60	4.55	4.50	Volts
R _l =	45.53	20.61	12.31	8.15	5.66	4.00	2.81	1.92	1.23	0.68	kOhms
RP30-xx12SF											
Trim up	1	2	3	4	5	6	7	8	9	10	%
Vout =	12.12	12.24	12.36	12.48	12.60	12.72	12.84	12.96	13.08	13.20	Volts
R _l =	367.91	165.95	98.64	64.98	44.78	31.32	21.70	14.49	8.88	4.39	kOhms
Trim down	1	2	3	4	5	6	7	8	9	10	%
Vout =	11.88	11.76	11.64	11.52	11.40	11.28	11.16	11.04	10.92	10.8	Volts
R _l =	460.99	207.95	123.60	81.42	56.12	39.25	27.20	18.16	11.13	5.51	kOhms
RP30-xx15SF											
Trim up	1	2	3	4	5	6	7	8	9	10	%
Vout =	15.15	15.3	15.45	15.60	15.75	15.90	16.05	16.20	16.35	16.50	Volts
R _l =	404.18	180.59	106.06	68.80	46.44	31.53	20.88	12.90	6.69	1.72	kOhms
Trim down	1	2	3	4	5	6	7	8	9	10	%
Vout =	14.85	14.70	14.55	14.40	14.25	14.10	13.95	13.80	13.65	13.50	Volts
R _l =	499.82	223.41	131.27	85.20	57.56	39.14	25.97	16.10	8.42	2.282	kOhms

PROTECTIONS			
Parameter	Condition	Value	
Short Circuit Protection (SCP)		Continuous, automatic recovery	
Over Voltage Protection (OVP)	Zener Diode Clamp	3.3Vout	3.9VDC
		5Vout	6.2VDC
		12Vout	15VDC
		15Vout	18VDC
Over Load Protection (OLP)	% of Iout rated	150% typ.	
Over Temperature Protection (OTP)		115°C typ.	
Isolation Voltage	I/P to O/P	1.6kVDC/1 minute	
	I/P to O/P to case	1.6kVDC/1 minute	
Isolation Resistance	500VDC	1GΩ min.	
Isolation Capacitance		1500pF max.	
Notes: Note8: This power module is not internally fused. An input line fuse must always be used.			

Specifications measured at Ta = 25°C, nominal input voltage, full load otherwise noted

ENVIRONMENTAL		
Parameter	Condition	Value
Operating Temperature Range	without derating	-40°C o +74°C
	with derating	-40°C to +97°C
Maximum Case Temperature		+105°C
Temperature Coefficient		±0.02%/°C max.
Thermal Impedance	Natural convection (20LFM)	12°C/Watt
	Natural convection (20LFM) with Heat-sink	10°C/Watt
Operating Humidity		5% - 95% RH
Thermal Shock		MIL-STD-810F
Vibration		MIL-STD-810F
MTBF	MIL-HDBK-217F	1453 x 10 ³ hours
	Bellcore TR-NWT-000332 ⁽⁹⁾	3173 x 10 ³ hours

Derating Graph⁽¹⁰⁾

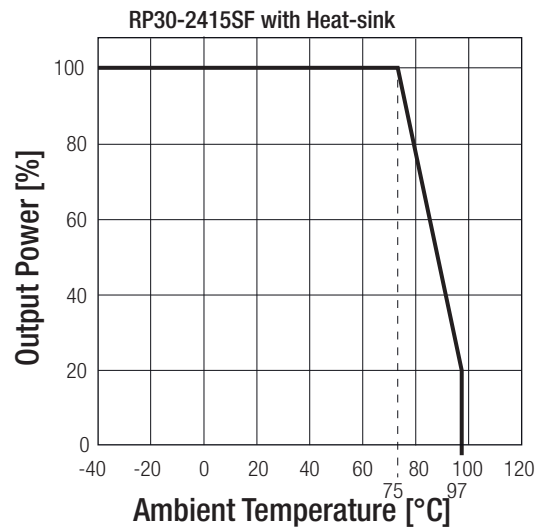
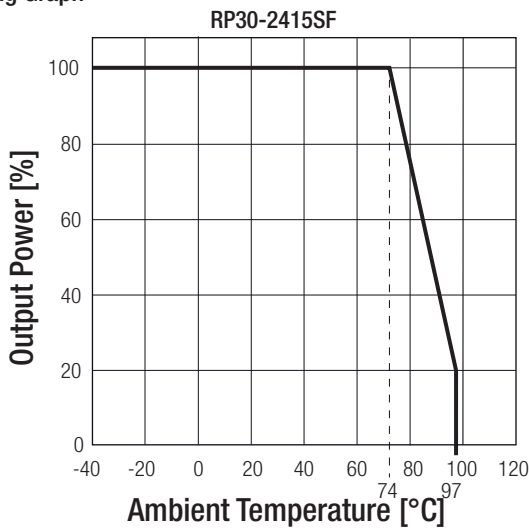

Notes:

Note9: BELLCORE TR-NWT-000332. Case I: 50% Stress, Temperature at 40°C (Ground fixed and controlled environment)
MIL-HDBK-217F Notice2 @ TA= 25°C, Full load (Ground, Benign, controlled environment)

Note10: Derating graphs are valid only for the shown part numbers. If you need detailed derating-information about a part-number not shown here please contact our technical support service at techsupportAT@recom-power.com

SAFETY AND CERTIFICATIONS

Certificate Type (Safety)	Report / File Number	Standard
UL General Safety	E196683	UL60950-1 1st. Ed.: 2003 C22.2 No. 60950 1st. Ed.: 2003
EMC Compliance	Condition	Standard / Criterion
EMI Standard ⁽¹¹⁾	with external filter	EN55022, Class A or B
ESD	Air ±8kV and Contact ±6kC	EN61000-4-2, Criteria A
Radiated Immunity	10 V/m	EN61000-4-3, Criteria A
Fast Transient ⁽¹²⁾	±2kV	EN61000-4-4, Criteria A
Surge ⁽¹²⁾	±1kV	EN61000-4-5, Criteria A
Conducted Immunity	10 Vr.m.s	EN61000-4-6, Criteria A

continued on next page

Specifications measured at Ta = 25°C, nominal input voltage, full load otherwise noted

Notes:

Note12: The standard modules meet EMI Class A or Class B with external components, see filter suggestions below.

Note13: An external input filter capacitor is required if the module has to meet EN61000-4-4, EN61000-4-5. The filter capacitor Recom suggests: 12VDC & 24VDC input Nippon chemi-con KY series, 330µF/50V
48VDC input Nippon chemi-con KY series, 220µF/100V

EMI Filtering Class A

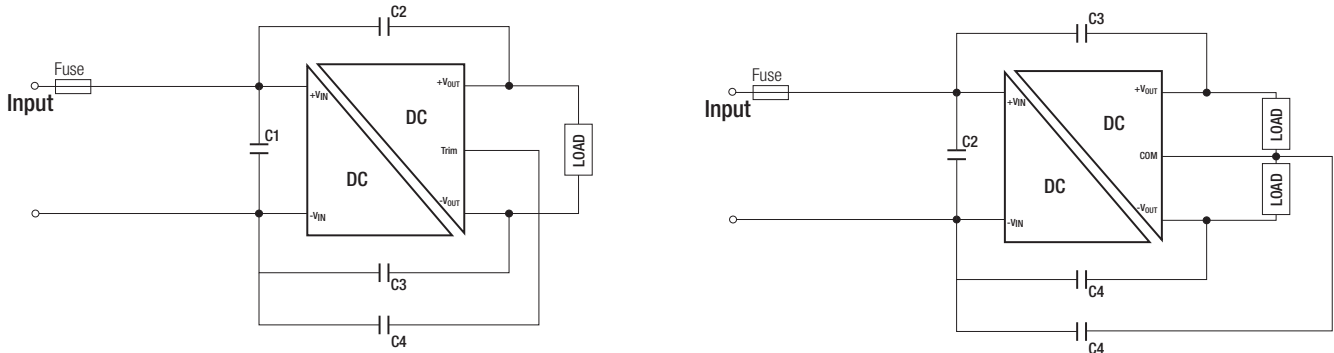

MODEL	C1	C2/C3/C4
RP30-12xxSF RP30-12xxDF	10µF/25V 1812 MLCC	1000pF/2kV 1808 MLCC
RP30-24xxSF RP30-24xxDF	4.7µF/50V 1812 MLCC	1000pF/2kV 1808 MLCC
RP30-48xxSF RP30-48xxDF	2.2µF/100V 1812 MLCC	1000pF/2kV 1808 MLCC

EMI Filtering Class B

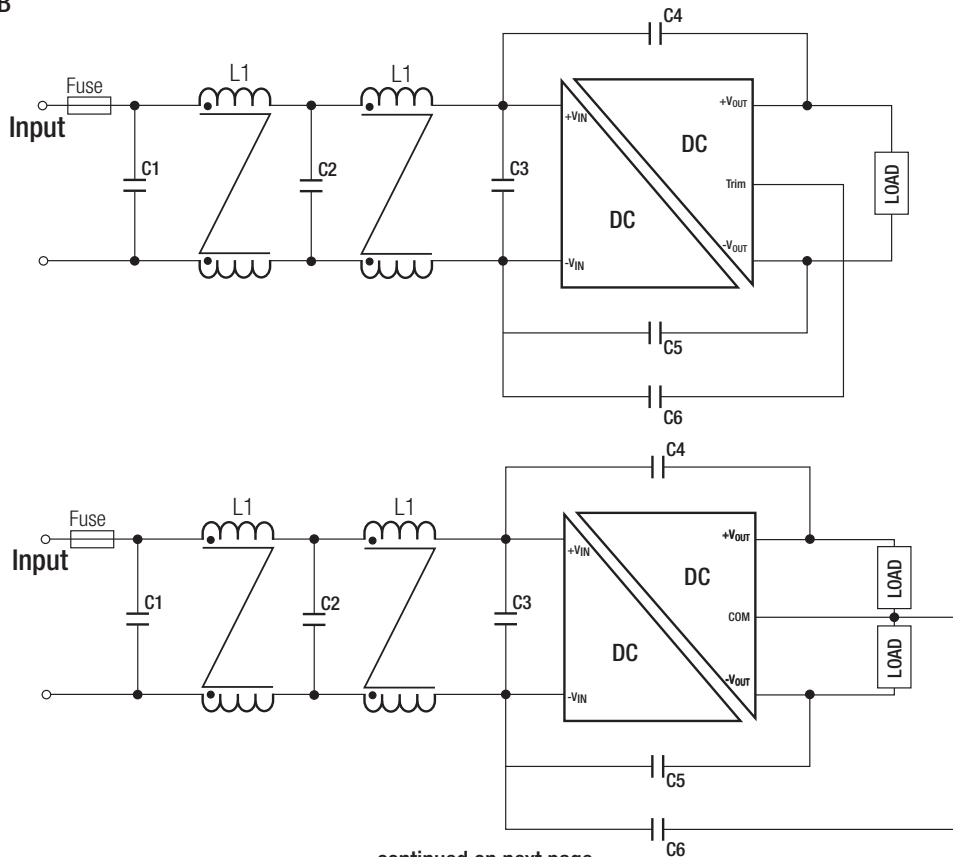

continued on next page

Specifications measured at Ta = 25°C, nominal input voltage, full load otherwise noted

MODEL	C1/C2/C3	C4/C5/C6	L1	L2
RP30-12xxSF RP30-12xxDF	10µF/25V 1812 MLCC	1000pF/2kV 1808 MLCC	CMC: 33.3µH ref.: WE 744842932 ref.: CMC-09	CMC: 55µH ref.: WE 744290560 ref.: CMC-10
RP30-24xxSF RP30-24xxDF	4.7µF/50V 1812 MLCC	1000pF/2kV 1808 MLCC	CMC: 33.3µH ref.: WE 744842932 ref.: CMC-09	CMC: 55µH ref.: WE 744290560 ref.: CMC-10
RP30-48xxSF RP30-48xxDF	2.2µF/100V 1812 MLCC	1000pF/2kV 1808 MLCC	CMC: 33.3µH ref.: WE 744842932 ref.: CMC-09	CMC: 55µH ref.: WE 744290560 ref.: CMC-10

DIMENSION and PHYSICAL CHARACTERISTICS

Parameter	Type	Value
Material	Case Base Potting	Nickel coated copper FR4 PCB Epoxy (UL94-V0)
Package Dimensions (LxWxH)	without Heat-sink with Heat-sink	50.8 x 25.4 x 10.2mm 56.8 x 25.4 x 16.8mm
Package Weight	without Heat-sink with Heat-sink	30.5g 41.39g

Dimension Drawing (mm)

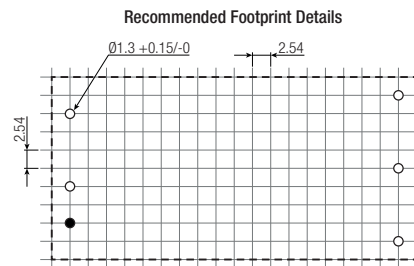
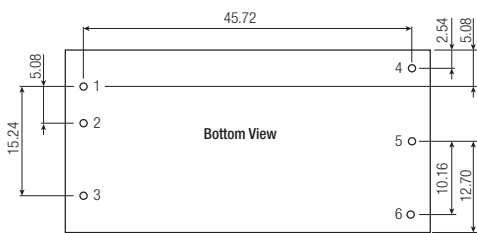
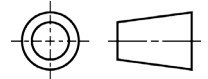
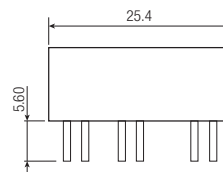
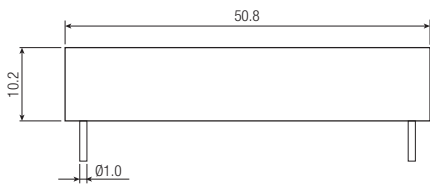

Pin Connections

Pin #	Single	Dual
1	+Vin	+Vin
2	-Vin	-Vin
3	CTRL	CTRL
4	+Vout	+Vout
5	-Vout	Com
6	Trim	-Vout

Pin Pitch Tolerance ±0.25 mm
Pin Dimension Tolerance ±0.1mm
Tolerance: X.X ±0.5mm
X.XX ±0.25mm

Dimension Drawing (mm) with Heat-sink

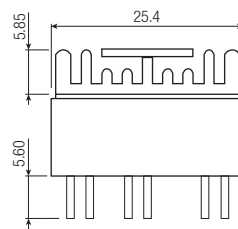
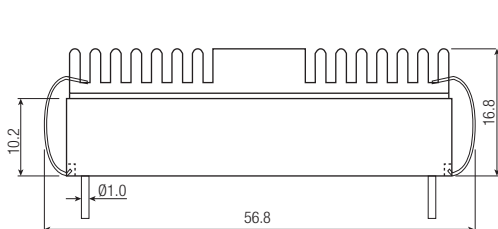
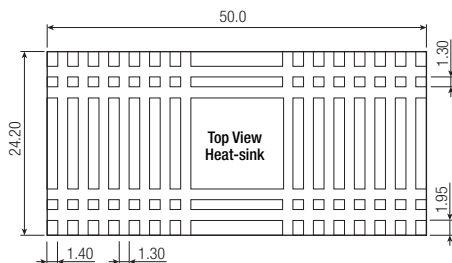

Specifications measured at Ta = 25°C, nominal input voltage, full load otherwise noted

PACKAGING INFORMATION		
Parameter	Type	Value
Packaging Quantity	without Heat-sink	9pcs.
	with Heat-sink	20pcs.
Storage Temperature Range		-55°C to +125°C
Storage Humidity		5% - 95% RH

The product information and specifications are subject to change without prior notice. RECOM products are not authorized for use in safety-critical applications (such as life support) without RECOM's explicit written consent. A safety-critical application is defined as an application where a failure of a RECOM product may reasonably be expected to endanger or cause loss of life, inflict bodily harm or damage property. The buyer shall indemnify and hold harmless RECOM, its affiliated companies and its representatives against any damage claims in connection with the unauthorized use of RECOM products in such safety-critical applications.