

Low Signal Relay G6A

Fully Sealed Relay with High Impulse Withstand

- High sensitivity — can be driven by digital circuits.
- Low-profile design allows use in 12.70 mm PC board rack.
- Surge withstand voltage meets FCC Part 68 regulation.
- Units can be mounted side by side due to low magnetic leakage.
- Special models available for low thermoelectromotive force.
- Unique moving loop (permanent magnet) armature reduces relay size, magnetic interference, and contact bounce time.
- Single or dual coil winding types available.
- RoHS Compliant

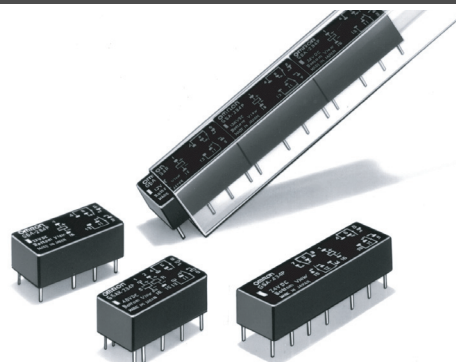

Ordering Information

To Order: Select the part number and add the desired coil voltage rating, (e.g., G6A-274P-ST-US-DC12).

■ Non-latching

| Type | Contact form | Model |
|-----------------|--------------|------------------|
| | | Ag (Au clad) |
| Standard | DPDT | G6A-274P-ST-US |
| Low-sensitivity | DPDT | G6A-274P-ST40-US |

■ Latching

Single Coil

| Type | Contact form | Model |
|----------|--------------|-----------------|
| | | Ag (Au clad) |
| Standard | DPDT | G6AU-274P-ST-US |

Dual Coil

| Type | Contact form | Model |
|-----------------|--------------|-------------------|
| | | Ag (Au clad) |
| Standard | DPDT | G6AK-274P-ST-US |
| Low-sensitivity | DPDT | G6AK-274P-ST40-US |

Specifications

■ Contact Data

| | | |
|----------------------------------|--|---|
| Type | G6A-274P-ST(40)-US G6AK-274P-ST(40)-US G6AU-274P-ST-US | |
| Load | Resistive load (p.f. = 1) | Inductive load (p.f. = 0.4) (L/R = 7 ms) |
| Rated load | 0.50 A at 125 VAC, 2 A at 30 VDC | 0.3 A* at 125 VAC, 1 A at 30 VDC |
| Contact material | Ag (Au clad) | |
| Carry current | 3 A | |
| Max. operating voltage | 250 VAC, 220 VDC | |
| Max. operating current | 2 A | 1 A |
| Max. switching capacity | 125 VA, 60 W | 62.50 VA, 30 W |
| Min. permissible load (See note) | 10 μA, 10 mVDC | |

* 0.25A at 125VAC for latching models

Note: P level: $\lambda_{60} = 0.1 \times 10^{-6}/\text{operation}$

This value was measured at a switching frequency of 60 operations/min and the criterion of contact resistance is 50 Ω. This value may vary depending on the switching frequency and operating environment. Always double-check relay suitability under actual operating conditions.

■ Coil Data

Standard Non-latching DPDT (G6A-274P-ST-US)

| Rated voltage (VDC) | Rated current (mA) | Coil resistance (Ω) | Coil inductance (ref. value) (H) | | Pick-up voltage | Dropout voltage | Maximum voltage | Power consumption (mW) |
|---------------------|--------------------|---------------------|----------------------------------|-------------|-----------------|-----------------|-----------------|------------------------|
| | | | Armature OFF | Armature ON | | | | |
| 3 | 66.70 | 45 | 0.07 | 0.065 | 70% max. | 10% min. | 200% at 23°C | Approx. 200 |
| 4.5 | 44.6 | 101 | 0.16 | 0.14 | | | | |
| 5 | 40 | 125 | 0.20 | 0.18 | | | | |
| 6 | 33.30 | 180 | 0.29 | 0.26 | | | | |
| 9 | 22.20 | 405 | 0.63 | 0.57 | | | | |
| 12 | 16.70 | 720 | 1.10 | 1.06 | | | | |
| 24 | 8.30 | 2,880 | 4.50 | 4.10 | | | | |
| 48 | 4.90 | 9,750 | 13.70 | 12.50 | | | | |
| | | | | | | | | Approx. 235 |

Low-sensitivity Non-latching DPDT (G6A-274P-ST40-US)

| Rated voltage (VDC) | Rated current (mA) | Coil resistance (Ω) | Coil inductance (ref. value) (H) | | Pick-up voltage | Dropout voltage | Maximum voltage | Power consumption (mW) |
|---------------------|--------------------|---------------------|----------------------------------|-------------|-----------------|-----------------|-----------------|------------------------|
| | | | Armature OFF | Armature ON | | | | |
| 3 | 133.30 | 22.50 | 0.03 | 0.02 | 70% max. | 10% min. | 150% at 23°C | Approx. 400 |
| 4.5 | 88.9 | 50.6 | 0.065 | 0.06 | | | | |
| 5 | 80 | 62.50 | 0.08 | 0.07 | | | | |
| 6 | 66.70 | 90 | 0.11 | 0.10 | | | | |
| 9 | 44.30 | 203 | 0.27 | 0.23 | | | | |
| 12 | 33.30 | 360 | 0.52 | 0.43 | | | | |
| 24 | 16.70 | 1,440 | 2.10 | 1.80 | | | | |
| 48 | 8.30 | 5,760 | 7.50 | 6.40 | | | | |

Note: 1. The rated current and coil resistance are measured at a coil temperature of 23°C with a tolerance of ±10%.

2. Operating characteristics are measured at a coil temperature of 23°C.

3. The maximum voltage is the highest voltage that can be imposed on the relay coil.

Standard Single Coil Latching DPDT (G6AU-274P-ST-US)

| Rated voltage (VDC) | Rated current (mA) | Coil resistance (Ω) | Coil inductance (ref. value) (H) | | Set pick-up voltage | Reset pick-up voltage | Maximum voltage | Power consumption (mW) |
|---------------------|--------------------|---------------------|----------------------------------|-------------|---------------------|-----------------------|-----------------|------------------------|
| | | | Armature OFF | Armature ON | | | | |
| 3 | 33.70 | 89 | 0.15 | 0.11 | 70% max. | 70% min. | 200% at 23°C | Approx. 100 |
| 4.5 | 22.2 | 202 | 0.34 | 0.25 | | | | |
| 5 | 20 | 250 | 0.44 | 0.35 | | | | |
| 6 | 16.70 | 360 | 0.64 | 0.48 | | | | |
| 9 | 11.10 | 810 | 1.38 | 1.07 | | | | |
| 12 | 8.30 | 1,440 | 2.50 | 2 | | | | |
| 24 | 4.20 | 5,760 | 9.20 | 7.20 | | | | |
| 48 | 2.50 | 19,000 | 28.50 | 22 | | | | |

Standard Dual Coil Latching DPDT (G6AK-274P-ST-US)

| Rated voltage (VDC) | Rated current (mA) | Coil resistance (Ω) | Coil inductance (ref. value) (H) | | | | Set pick-up voltage | Reset pick-up voltage | Maximum voltage | Power consumption (mW) |
|---------------------|--------------------|---------------------|----------------------------------|-------------|--------------|-------------|---------------------|-----------------------|-----------------|------------------------|
| | | | Set coil | | Reset coil | | | | | |
| | | | Armature OFF | Armature ON | Armature OFF | Armature ON | | | | |
| 3 | 66.70 | 45 | 0.037 | 0.027 | 0.027 | 0.037 | 70% max. | 70% min. | 200% at 23°C | Approx. 200 |
| 4.5 | 40.2 | 112 | 0.09 | 0.065 | 0.065 | 0.09 | | | | |
| 5 | 36 | 139 | 0.11 | 0.08 | 0.08 | 0.11 | | | | |
| 6 | 30 | 200 | 0.16 | 0.12 | 0.12 | 0.16 | | | | |
| 9 | 20 | 450 | 0.38 | 0.28 | 0.28 | 0.38 | | | | |
| 12 | 15 | 800 | 0.60 | 0.45 | 0.45 | 0.60 | | | | |
| 24 | 7.50 | 3,200 | 2.10 | 1.50 | 1.50 | 2.10 | | | | |
| 48 | 4.20 | 11,520 | 8.50 | 6.30 | 6.30 | 8.50 | | | | |

Low-sensitivity Dual Coil Latching DPDT (G6AK-274P-ST40-US)

| Rated voltage (VDC) | Rated current (mA) | Coil resistance (Ω) | Coil inductance (ref. value) (H) | | | | Set pick-up voltage | Reset pick-up voltage | Maximum voltage | Power consumption (mW) |
|---------------------|--------------------|---------------------|----------------------------------|-------------|--------------|-------------|---------------------|-----------------------|-----------------|------------------------|
| | | | Set coil | | Reset coil | | | | | |
| | | | Armature OFF | Armature ON | Armature OFF | Armature ON | | | | |
| 3 | 120 | 25 | 0.015 | 0.01 | 0.01 | 0.015 | 70% max. | 70% min. | 150% at 23°C | Approx. 360 |
| 4.5 | 79.9 | 56.3 | 0.04 | 0.025 | 0.025 | 0.04 | | | | |
| 5 | 72.50 | 69 | 0.05 | 0.035 | 0.035 | 0.05 | | | | |
| 6 | 60 | 100 | 0.07 | 0.05 | 0.05 | 0.07 | | | | |
| 9 | 40 | 225 | 0.16 | 0.12 | 0.12 | 0.16 | | | | |
| 12 | 30 | 400 | 0.28 | 0.20 | 0.20 | 0.28 | | | | |
| 24 | 15 | 1,600 | 1.10 | 0.75 | 0.75 | 1.10 | | | | |
| 48 | 7.50 | 6,400 | 4 | 2.90 | 2.9 | 4 | | | | |

- Note:**
1. The rated current and coil resistance are measured at a coil temperature of 23°C with a tolerance of ±10%.
 2. Operating characteristics are measured at a coil temperature of 23°C.
 3. The maximum voltage is the highest voltage that can be imposed on the relay coil.

■ Characteristics

| Type | | Non-latching | Latching |
|---|-------------------------------|--|--|
| Contact resistance (See note 1) | | 50 mΩ max. | |
| Operate (set) time (See note 2) | DPDT | 5 ms max. (mean value approx. 3 ms) | 5 ms max. (mean value approx. 2.50 ms) |
| Release (reset) time (See note 2) | DPDT | 3 ms max. (mean value approx. 1.20 ms) | 5 ms max. (mean value approx. 2.50 ms) |
| Min. set/reset signal width | DPDT | 7 ms min. | |
| Operating frequency | Mechanical | 36,000 operations/hour | |
| | Electrical | 1,800 operations/hour (under rated load) | |
| Insulation resistance (See note 3) | | 1,000 MΩ min. (at 500 VDC); except for set-reset | |
| Dielectric strength | | 1,000 VAC, 50/60 Hz for 1 minute between coil and contacts 1,000 VAC, 50/60 Hz for 1 minute between contacts of different poles 1,000 VAC, 50/60 Hz for 1 minute between contacts of same pole 250 VAC, 50/60 Hz for 1 minute between set and reset coils | |
| Surge withstand voltage | | 1,500 V (10 x 160 μs) (conforms to FCC Part 68) | |
| Vibration | Mechanical durability | 10 to 55 Hz; 5 mm double amplitude | |
| | Malfunction durability | 10 to 55 Hz; 3.3 mm double amplitude | |
| Shock | Mechanical durability | 1,000 m/s ² (Approx. 100G) | |
| | Malfunction durability | DPDT: 500 m/s ² (Approx. 50 G) | |
| Ambient temperature | | -40° to 70°C with no icing | |
| Humidity | | 5% to 85% RH | |
| Service life | Mechanical | 100 million operations min. (at 36,000 operations/hour) | |
| | Electrical | 500,000 operations min. (at 1,800 operations/hr) See "Characteristic Data" | |
| Weight | DPDT | Approx. 3.5 g | |
| | 4PDT | Approx. 6.0 g | |

- Note:**
- The contact resistance was measured with 10 mA at 1 VDC with a fall-of-potential method.
 - Values in parentheses are typical values unless otherwise stated.
 - The insulation resistance was measured with a 500-VDC megohmmeter applied to the same parts as those for checking the dielectric strength (except between the set and reset coil).
 - The above values are initial values.

■ Approvals

UL Recognized (File No. E41515) / CSA Certified (File No. LR31928) - - Ambient Temp. = 40°C

| Type | Contact form | Coil rating | Contact ratings | Number of test operations |
|----------------------|--------------|---------------|---|---------------------------|
| G6A()-274P-ST()-US | DPDT | 1.5 to 48 VDC | 1 A at 125 VAC (General Purpose) 2 A at 30 VDC (General Purpose) 0.6 A at 110 VDC (General Purpose) | 6,000 |

- Note:**
- The rated values approved by each of the safety standards (e.g., UL and CSA) may be different from the performance characteristics individually defined in this catalog.
 - In the general interest of product improvement, specifications are subject to change.

■ Characteristic Data

Maximum Switching Capacity DPDT

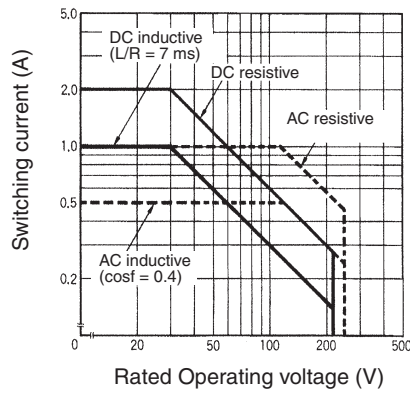

Ambient Temperature vs. Maximum Coil Voltage

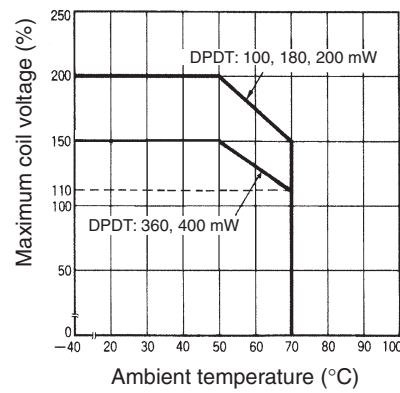

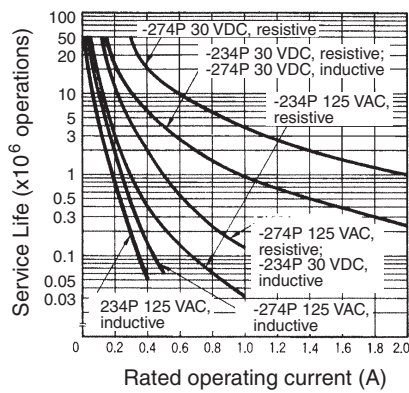

Note: The maximum coil voltage refers to the maximum value in a varying range of operating power voltage, not a continuous voltage.

Electrical Service Life DPDT



Dimensions

Note: 1. All units are in millimeters unless otherwise indicated.
 2. Orientation marks are indicated as follows:  

■ Non-latching

G6A-274P-ST(40)-US

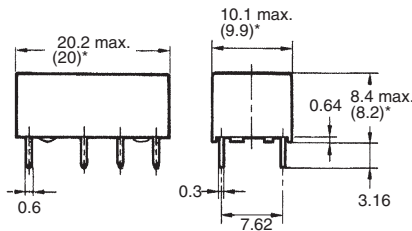
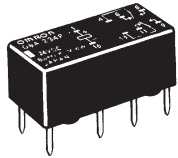

*Average value

Terminal Arrangement/
Internal Connections
(Bottom View)

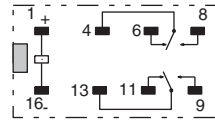

Mounting Holes
(Bottom View)

Tolerance: ± 0.1

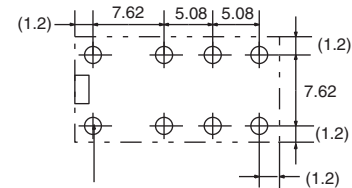

Eight, 1.0-dia. holes

■ Latching

G6AU-274P-ST-US

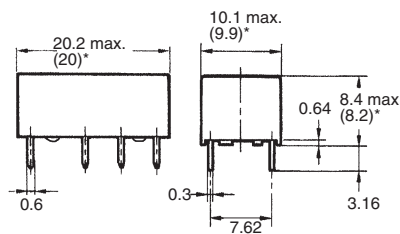
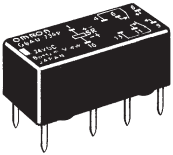

*Average value

Terminal Arrangement/
Internal Connections
(Bottom View)

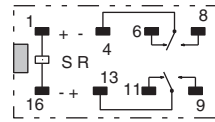

Mounting Holes
(Bottom View)

Tolerance: ± 0.1

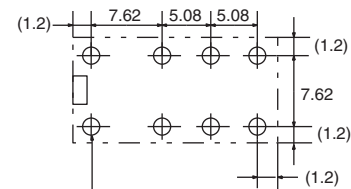

Eight, 1.0-dia. holes

G6AK-274P-ST(40)-US

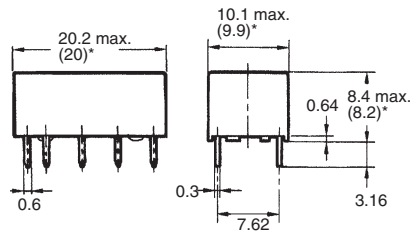
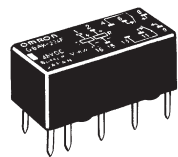

*Average value

Terminal Arrangement/
Internal Connections
(Bottom View)

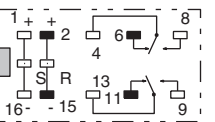

Mounting Holes
(Bottom View)

Tolerance: ± 0.1

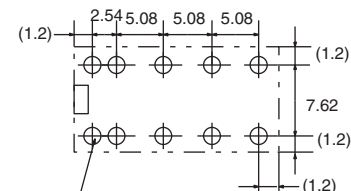

Ten, 1-dia. holes

Precautions

Long-term Continuously ON Contacts

Using the Relay in a circuit where the Relay will be ON continuously for long periods (without switching) can lead to unstable contacts because the heat generated by the coil itself will affect the insulation, causing a film to develop on the contact surfaces. Be sure to use a fail-safe circuit design that provides protection against contact failure or coil burnout. Otherwise, use a latching relay.

Relay Handling

When washing the product after soldering the Relay to a PCB, use a water-based solvent or alcohol-based solvent, and keep the solvent temperature to less than 40°C. Do not put the Relay in a cold cleaning bath immediately after soldering.



All sales are subject to Omron Electronic Components LLC standard terms and conditions of sale, which can be found at http://www.components.omron.com/components/web/webfiles.nsf/sales_terms.html

ALL DIMENSIONS SHOWN ARE IN MILLIMETERS.

To convert millimeters into inches, multiply by 0.03937. To convert grams into ounces, multiply by 0.03527.

OMRON[®]

**OMRON ELECTRONIC
COMPONENTS LLC**

55 E. Commerce Drive, Suite B
Schaumburg, IL 60173

847-882-2288

OMRON ON-LINE

Global - <http://www.omron.com>

USA - <http://www.components.omron.com>

Cat. No. X301-E-1b

09/11

Specifications subject to change without notice

Printed in USA

Mouser Electronics

Authorized Distributor

Click to View Pricing, Inventory, Delivery & Lifecycle Information:

Omron:

[G6A-234P-BS-DC5](#) [G6A-234P-ST-US-DC12](#) [G6A-234P-ST-US-DC5](#) [G6A-234P-ST-US-DC3](#) [G6A-234P-ST15-US-DC5](#) [G6A-234P-ST-US-DC6](#) [G6A-234P-ST-US-DC9](#) [G6A-234P-ST15-US-DC3](#) [G6A-234P-ST15-US-DC6](#) [G6A-234P-ST15-US-DC9](#) [G6A-234P-ST15-US-DC12](#) [G6A-234P-ST15-US-DC24](#) [G6A-234P-ST15-US-DC48](#) [G6A-234P-ST40-US-DC5](#) [G6A-234P-ST40-US-DC9](#) [G6A-234P-ST40-US-DC48](#) [G6AK-474P-ST-US-DC9](#) [G6A-234P-BS DC9](#) [G6A-234P-BS-DC12](#) [G6A-234P-ST10-US DC24](#) [G6A-234P-ST10-US DC9](#) [G6A-234P-ST10-US-DC48](#) [G6A-234P-ST31 DC12](#) [G6A-234P-ST-US DC4.5](#) [G6A-234P-ST-US-DC48](#) [G6A-234P-ST40-USDC12](#) [G6A-234P-ST-US-DC24](#) [G6A-234P-ST15-US DC4.5](#) [G6A-234P-ST-US-DC18](#) [G6AK-434P-ST-US DC12](#) [G6A-234P-ST40-US-DC24](#) [G6A-2-H-DC24](#) [G6A-234P-BS DC4.5](#) [G6A-234P-ST40-US-DC12](#) [G6A-234P-ST1-US DC12](#) [G6A-2-H-DC12](#) [G6A-234P-ST1-US DC5](#) [G6A-2-L-DC24](#) [G6AU-234P-BS DC5](#) [G6AK-2-H DC3](#)