

3rd. Over Tone Quartz Crystal Oscillator

GENERAL DESCRIPTION

The NJU6397 series that is a C-MOS IC for quartz crystal oscillator consists of an oscillation amplifier and 3-state output buffer.

The series has three types of A, B and C. The frequency range of the A type is from 75 to 90MHz, and the B type is from 90 to 110MHz, and the C type is from 110 to 135MHz.

The oscillation amplifier realizes very low oscillation stop current with NAND circuit.

The 3-state output buffer is C-MOS compatible.

FEATURES

- Operating Voltage 2.3 to 3.6V
- Maximum Oscillation Frequency (See Line-up Table)
- High Fan-out $I_{OH}/I_{OL} = 6mA @ V_{DD} = 2.5V$
 $I_{OH}/I_{OL} = 8mA @ V_{DD} = 3.3V$
- Oscillation Stop and Output Stand-by Function
- 3-State Output Buffer
- Oscillation Capacitors C_g and C_d on-Die
- Package Outline Thin-Die/Wafer
- C-MOS Technology

PACKAGE OUTLINE



NJU6397XC-X

PAD LOCATION

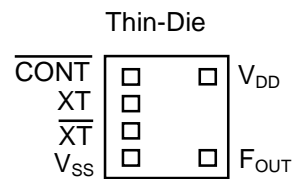

LINE-UP TABLE

Type No.	Recommended Oscillation Frequency	Output Frequency	C_g/C_d
NJU6397	A 75 to 90MHz	f_0	11/12pF
	B 90 to 110MHz		9/10pF
	C 110 to 135MHz		8/9pF

Note1) The oscillation frequency range has used NJRC's characteristics authentication crystal for measurement. However is not guaranteed.

COORDINATES

No	Pad Name	X	Y
1	CONT	-178	231
2	XT	-178	77
3	XT	-178	-77
4	V_{SS}	-178	-231
5	F_{OUT}	206	-231
8	V_{DD}	206	231

Starting Point: Die Center Unit[um]
 Die Size: 0.70x0.75mm
 Thin-Die Thickness(C-D): 200±20um
 Thin-Die Thickness(C-L): 140±10um
 Wafer Thickness(W-H): 200±20um
 Wafer Thickness(W-L): 140±10um
 Pad Size: 90x90um
 Die Substrate: V_{DD} Level

BLOCK DIAGRAM

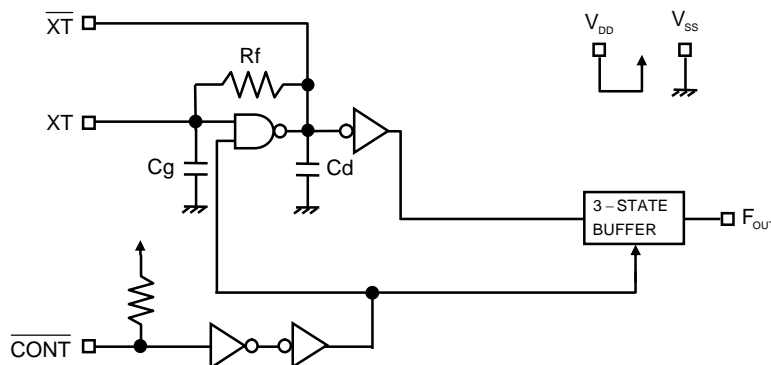

TERMINAL DESCRIPTION

SYMBOL	FUNCTION	
$\overline{\text{CONT}}$	Oscillation and 3-state Output Buffer Control	
	$\overline{\text{CONT}}$	F_{OUT}
	H or OPEN	Output frequency f_0
	L	Oscillation Stop and High impedance Output
$\overline{\text{XT}}$	Quartz Crystal Connecting Terminals	
$\overline{\text{XT}}$		
V_{SS}	$V_{\text{SS}}=0\text{V}$	
F_{OUT}	Frequency Output	
V_{DD}	$V_{\text{DD}}=2.5\text{V}/3.3\text{V}$	

ABSOLUTE MAXIMUM RATINGS

($T_a=25^\circ\text{C}$)

PARAMETER	SYMBOL	RATING	UNIT
Supply Voltage	V_{DD}	-0.5 to +7.0	V
Input Voltage	V_{IN}	$V_{\text{SS}}-0.5$ to $V_{\text{DD}}+0.5$	V
Output Voltage	V_{O}	-0.5 to $V_{\text{DD}}+0.5$	V
Input Current	I_{IN}	± 10	mA
Output Current	I_{O}	± 25	mA
Operating Temperature Range	T_{opr}	-40 to +85	$^\circ\text{C}$
Storage Temperature Range	T_{stg}	-55 to +125	$^\circ\text{C}$

Note2) If the supply voltage(V_{DD}) is less than 7.0V, the input voltage must not over the V_{DD} level though 7.0V is limit specified.

Note3) Decoupling capacitor should be connected between V_{DD} and V_{SS} due to the stabilized operation for the circuit.

ELECTRICAL CHARACTERISTICS

(Ta=25°C)

PARAMETER	SYMBOL	CONDITIONS	MIN	TYP	MAX	UNIT
Operating Voltage	V _{DD}		2.3		3.6	V
Recommended Oscillation Frequency	f	A type Note4)	75		90	MHz
		B type Note4)	90		110	
		C type Note4)	110		135	

Note4) The oscillation frequency range has used NJRC's characteristics authentication crystal for measurement. However it is not guaranteed.

A,B,C and E type

(V_{DD}=2.5V, Ta=25°C)

PARAMETER	SYMBOL	CONDITIONS	MIN	TYP	MAX	UNIT
Operating Current	I _{DD1}	A type, fosc=90MHz, C _L =15pF		10	20	mA
		B type, fosc=110MHz, C _L =15pF		10	20	
		C type, fosc=135MHz, C _L =15pF		15	30	
Oscillation Stopping Current	I _{DD2}	CONT=V _{SS} , No load		2	5	uA
Stand-by Current	I _{st}	CONT=XT=V _{SS} , No load Note5)			1	uA
Input Voltage	V _{IH}		2.0		2.5	V
	V _{IL}		0		0.5	V
Output Current	I _{OH}	V _{OH} =2.2V	6			mA
	I _{OL}	V _{OL} =0.3V	6			mA
Input Current	I _{IN}	CONT=0.8V _{DD}		7.5	12.0	uA
		CONT=0.2V _{DD}		1.2	2.0	uA
3-state Off Leakage Current	I _{OZ}	CONT=V _{SS} , F _{OUT} = V _{DD} or V _{SS}			±0.1	uA
Feedback Resistance	R _f	A type		3.8		kΩ
		B type		3.8		
		C type		2.9		
Internal Capacitor	C _g /C _d	A type, fosc=90MHz		11/12		pF
		B type, fosc=110MHz		9/10		
		C type, fosc=135MHz		8/9		
Oscillation Frequency	f	A type Note6)			90	MHz
		B type Note6)			110	
		C type Note6)			135	
Output Signal Symmetry	SYM	C _L =15pF, @V _{DD} /2	45	50	55	%
Output Signal Rise Time	t _r	C _L =15pF, 10% to 90%		3	4	ns
Output Signal Fall Time	t _f	C _L =15pF, 90% to 10%		3	4	ns
Output Disable time	t _{PLZ}	C _L =15pF, R _{UP} =10kΩ			200	ns
Output Enable Time	t _{PZL}	C _L =15pF, R _{UP} =10kΩ			200	ns

Note5) Excluding input current on CONT Terminal.

Note6) The oscillation frequency has used NJRC's characteristics authentication crystal for measurement. However it is not guaranteed.

($V_{DD}=3.3V, T_a=25^{\circ}C$)

PARAMETER	SYMBOL	CONDITIONS	MIN	TYP	MAX	UNIT
Operating Current	I_{DD1}	A type, $f_{osc}=90MHz, C_L=15pF$		13	25	mA
		B type, $f_{osc}=110MHz, C_L=15pF$		13	28	
		C type, $f_{osc}=135MHz, C_L=15pF$		18	35	
Oscillation Stopping Current	I_{DD2}	CONT= V_{SS} , No load		5	10	μA
Stand-by Current	I_{st}	CONT=XT= V_{SS} , No load Note5)			1	μA
Input Voltage	V_{IH}		2.3		3.3	V
	V_{IL}		0		1.0	V
Output Current	I_{OH}	$V_{OH}=2.97V$	8			mA
	I_{OL}	$V_{OL}=0.33V$	8			mA
Input Current	I_{IN}	CONT= $0.8V_{DD}$		12.5	18.0	μA
		CONT= $0.2V_{DD}$		2.5	3.5	μA
3-state Off Leakage Current	I_{OZ}	CONT= V_{SS} , $F_{OUT}=V_{DD}$ or V_{SS}			± 0.1	μA
Feedback Resistance	R_f	A type		3.8		k Ω
		B type		3.8		
		C type		2.9		
Internal Capacitor	C_g/C_d	A type, $f_{osc}=90MHz$		11/12		pF
		B type, $f_{osc}=110MHz$		9/10		
		C type, $f_{osc}=135MHz$		8/9		
Oscillation Frequency	f	A type Note6)			90	MHz
		B type Note6)			110	
		C type Note6)			135	
Output Signal Symmetry	SYM	$C_L=15pF, @V_{DD}/2$	45	50	55	%
Output Signal Rise Time	t_r	$C_L=15pF, 10\%$ to 90%		2	3	ns
Output Signal Fall Time	t_f	$C_L=15pF, 90\%$ to 10%		2	3	ns
Output Disable time	t_{PLZ}	$C_L=15pF, R_{UP}=10k\Omega$			150	ns
Output Enable Time	t_{PZL}	$C_L=15pF, R_{UP}=10k\Omega$			150	ns

Note5) Excluding input current on CONT Terminal.

Note6) The oscillation frequency has used NJRC's characteristics authentication crystal for measurement. However it is not guaranteed.

MEASUREMENT CIRCUITS

(1) Output Signal Symmetry ($C_L=15\text{pF}$)

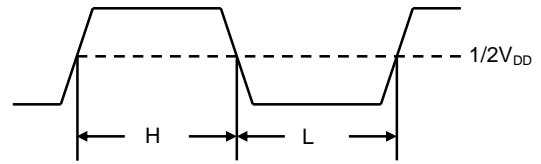
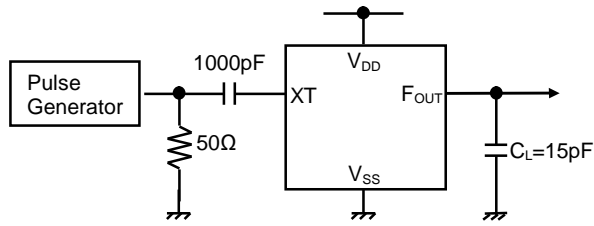

(2) Output Signal Rise/Fall Time ($C_L=15\text{pF}$)

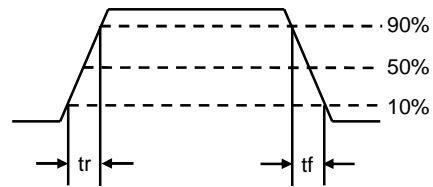
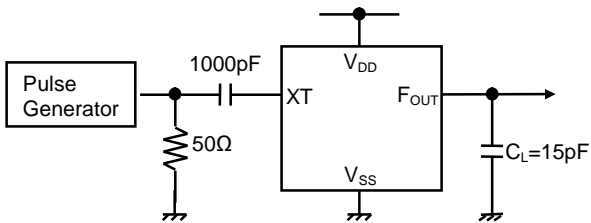

(3) Output Disable/Enable Time ($C_L=15\text{pF}, R_{UP}=10\text{k}\Omega$)

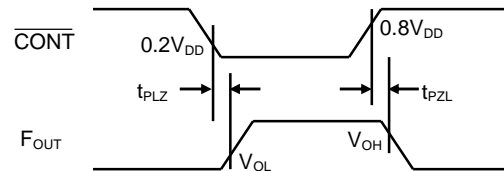
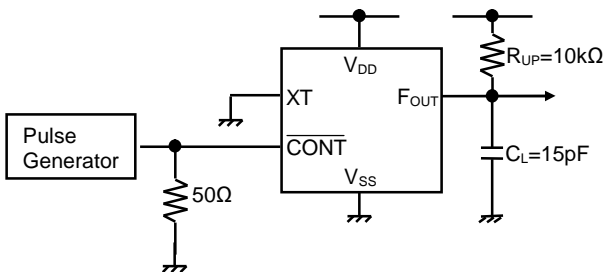

[CAUTION]
 The specifications on this data book are only given for information, without any guarantee as regards either mistakes or omissions. The application circuits in this data book are described only to show representative usages of the product and not intended for the guarantee or permission of any right including the industrial rights.

Mouser Electronics

Authorized Distributor

Click to View Pricing, Inventory, Delivery & Lifecycle Information:

[NJR:](#)

[NJU6397BC](#) [NJU6397BC-D](#) [NJU6397CC](#) [NJU6397AC](#) [NJU6397CC-D](#) [NJU6397AC-D](#)