

Circular Connectors Conforming to JIS C 5432

JR Series



■ Features

1. These round connectors conform to JIS C 5432 "Circular connectors for electric appliances."

■ Product Specifications

Ratings	Rated current	Shell size	Number of contacts	Rated current
		13	3	10A
16	7	5	5A	
		10, 14	10A	
21	10	16	5A (Crimp type : 3A)	
		26	5A (Contact numbers A and B only : 10A)	
		4	30A	
25	5, 16	24	10A	
		24	5A (Crimp type : 3A)	

Ratings	Rated voltage	Shell size	Number of contacts	Rated voltage
		13	3, 5	AC250, DC350V
16	7, 10, 14			
21	10, 16, 26			
25	4, 5	16, 24	AC1000V, DC1400V	
		16, 24	AC250, DC350V	

Ratings	Operating temperature range	-25 to +85°C
	Storage temperature range	-10 to +60°C

Items	Specifications	Conditions
1. Contac resistance	5mΩ max. JR 21-16 contact crimping type : 10mΩ max. JR 25-24 contact crimping type : 10mΩ max.	Measured at DC 1A
2. Insulation resistance	1,000MΩ min. JR 25-4 and 5 contacts : 10,000MΩ min.	Measured at DC 500V
3. Withstanding voltage	No flashover or dielectric breakdown.	AC 1,000V for 1 minute JR 25-4, 5 contacts : AC 3,000V for 1 minute
4. Vibration resistance	No electrical discontinuity for 10μs or greater	10 to 55Hz/cycle, amplitude : 0.75mm, 3 directions, 2 hours each
5. Shock resistance	No electrical discontinuity for 10μs or greater	Acceleration : 490m/s ² , duration : 11ms, 6 axis directions, 3 cycles each
6. Mating cycles	Contact resistance : 10mΩ max.	500 times
7. Temperature cycle	Insulation resistance : 1,000MΩ min. JR 25-4 and 5 contacts : Insulation resistance : 10,000MΩ min.	-40°C : 30 minutes → Normal temperature : 10 to 15 minutes → 100°C : 30 minutes → Normal temperature : 10 to 15 minutes, left for 5 cycles
8. Moisture resistance	Insulation resistance (when dry) 100MΩ min. 5,000MΩ min. : JR 25-4 , 5 contacts	Temperature : 40°C, relative humidity: 90 to 95%, left for 96 hours

■ Materials / Finish

Part	Material	Finish	Remarks
Shell	Aluminum alloy	Nickel plating	————
Insulator	Phenol resin PPS resin	————	UL94V-0
Contact	Copper alloy	Silver plating	————

Product Number Structure

Refer to the chart below when determining the product specifications from the product number.
Please select from the product numbers listed in this catalog when placing orders.

JR 16 P A - 10 S C ()**
 ① ② ③ ④ ⑤ ⑥ ⑦ ⑧

① Model name : JR Series	⑤ Number of contacts
② Shell size : The shell size is the outer shell diameter of the mating end of the plug.	⑥ Contact form P : Male contact S : Female contact
③ Shell type P : Threaded lock plug J : Threaded lock jack R : Threaded lock receptacle BP : Bayonet-lock plug RC : Threaded lock receptacle cap BR : Bayonet-lock receptacle	⑦ Contact termination method: None : Solder termination C : Crimp termination
④ Shell variation : Letters such as A, B, C, etc. indicate variations in the shell.	⑧ Other specifications : A two-digit number is added to indicate other specifications.

Solder Type

● Threaded lock plug

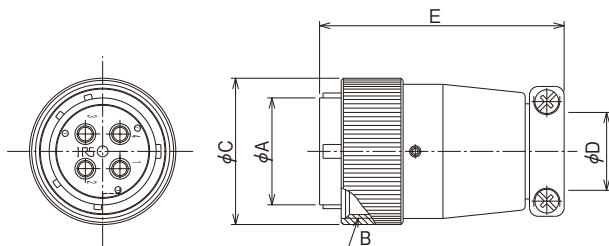

Part No.	HRS No.	No. of contacts	φA	B	φC	φD	E	JIS No.
JR13PK-3P(71)	114-0501-7 71	3	12.7	M18×1	21.8	8.5	45.5	CNR01SPM013003
JR13PK-5P(71)	114-0502-0 71	5						CNR01SPM013005
JR16PK-7P(71)	114-0503-2 71	7	16.3	M22×1	25.8	11.5	49.5	CNR01SPM016007
JR16PK-10P(71)	114-0504-5 71	10						CNR01SPM016010
JR21PK-10P(71)	114-0505-8 71	10	20.5	M26×1	29.8	15	53.5	CNR01SPM021010
JR21PK-16P(71)	114-0506-0 71							CNR01SPM021016
JR25PK-16P(71)	114-0507-3 71	16	24.7	M30×1	33.8	18	56.5	CNR01SPM025016
JR25PK-24P(71)	114-0508-6 71							CNR01SPM025024
JR25PH-4P	114-0626-2	4	24.7	M30×1	33.8	18	56.5	—————
JR25PH-5P	114-0624-7	5						—————
JR13PK-3S(71)	114-0509-9 71	3	12.7	M18×1	21.8	8.5	45.5	CNR01SPF013003
JR13PK-5S(71)	114-0510-8 71	5						CNR01SPF013005
JR16PK-7S(71)	114-0511-0 71	7	16.3	M22×1	25.8	11.5	49.5	CNR01SPF016007
JR16PK-10S(71)	114-0512-3 71	10						CNR01SPF016010
JR21PK-10S(71)	114-0513-6 71	10	20.5	M26×1	29.8	15	53.5	CNR01SPF021010
JR21PK-16S(71)	114-0514-9 71							CNR01SPF021016
JR25PK-16S(71)	114-0515-1 71	16	24.7	M30×1	33.8	18	56.5	CNR01SPF025016
JR25PK-24S(71)	114-0516-4 71							CNR01SPF025024
JR25PH-4S	114-0627-5	4	24.7	M30×1	33.8	18	56.5	—————
								—————

● Threaded lock receptacle

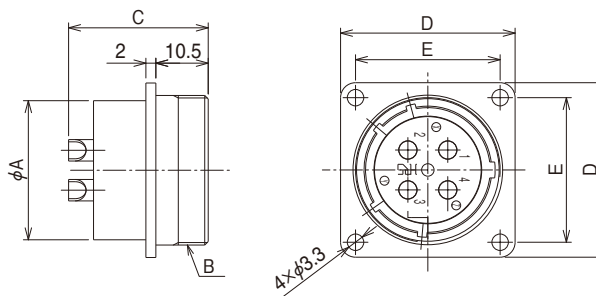

Part No.	HRS No.	No. of contacts	ϕA	B	C	D	E	JIS No.
JR13RK-3P	114-0517-7	3	15.9	M18x1	26.6	26	20	CNR01SRM013003
JR13RK-5P	114-0518-0	5			26.1			CNR01SRM013005
JR16RK-7P	114-0519-2	7	19.9	M22x1	26.6	29	23	CNR01SRM016007
JR16RK-10P	114-0520-1	10			26.1			CNR01SRM016010
JR21RK-10P	114-0521-4		16	23.9	M26x1	26.6	32	26
JR21RK-16P	114-0522-7	26.1				CNR01SRM021016		
JR25RK-16P	114-0523-0	24	27.9	M30x1	26.6	35	29	CNR01SRM025016
JR25RK-24P	114-0524-2				26.1			CNR01SRM025024
JR25RH-4P	114-0628-8	4	15.9	M18x1	28	26	20	—————
JR13RK-3S	114-0525-5	3			27			CNR01SRF013003
JR13RK-5S	114-0526-8	5	19.9	M22x1	28	29	23	CNR01SRF016007
JR16RK-7S	114-0527-0	7			27			CNR01SRF016010
JR16RK-10S	114-0528-3	10	23.9	M26x1	28	32	26	CNR01SRF021010
JR21RK-10S	114-0529-6				27			CNR01SRF021016
JR21RK-16S	114-0530-5	16	27.9	M30x1	28	35	29	CNR01SRF025016
JR25RK-16S	114-0531-8				27			CNR01SRF025016
JR25RK-24S	114-0532-0	24	27.9	M30x1	27	35	29	CNR01SRF025024
JR25RH-4S	114-0629-0	4			28			—————
JR25RH-5S	114-0625-0	5			27.8			—————

● Threaded lock jack

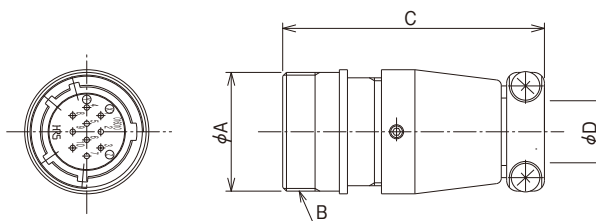

Part No.	HRS No.	No. of contacts	ϕA	B	C	ϕD
JR13JK-3P	114-0533-3	3	19	M18x1	44.5	8.5
JR13JK-5P	114-0534-6	5				
JR16JK-7P	114-0535-9	7	23	M22x1	48.5	11.5
JR16JK-10P	114-0536-1	10				
JR21JK-10P	114-0537-4		16	27	M26x1	52.5
JR21JK-16P	114-0538-7					
JR25JK-16P	114-0539-0	24	31	M30x1	55.5	18
JR25JK-24P	114-0540-9					
JR13JK-3S	114-0541-1	3	19	M18x1	44.5	8.5
JR13JK-5S	114-0542-4	5				
JR16JK-7S	114-0543-7	7	23	M22x1	48.5	11.5
JR16JK-10S	114-0544-0	10				
JR21JK-10S	114-0545-2		16	27	M26x1	52.5
JR21JK-16S	114-0546-5					
JR25JK-24S	114-0548-0	24	31	M30x1	55.5	18

Dec.1.2018 Copyright 2018 HIROSE ELECTRIC CO., LTD. All Rights Reserved.

■ Crimp Type

● Threaded lock plug

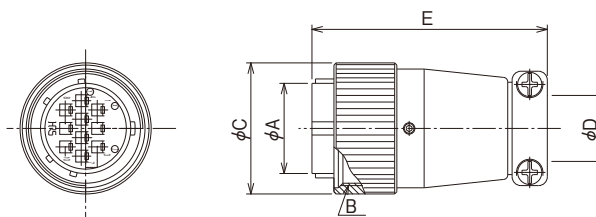

Part No.	HRS No.	No. of contacts	ϕA	B	ϕC	ϕD	E	Remarks
JR21PK-10PC(71)	114-0570-0 71	10	20.5	M26×1	29.8	15	53.5	Contact $\phi 1.6$
JR21PK-10SC(71)	114-0571-2 71							
JR21PK-16PC(71)	114-0572-5 71	16	20.5	M26×1	29.8	15	53.5	Contact $\phi 1$
JR21PK-16SC(71)	114-0573-8 71							
JR25PK-24PC(71)	114-0574-0 71	24	24.7	M30×1	33.8	18	56.5	
JR25PK-24SC(71)	114-0575-3 71							

● Threaded lock receptacle

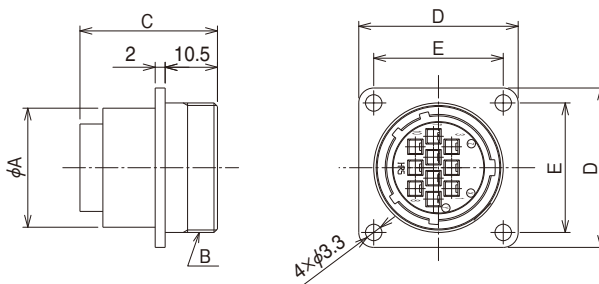

Part No.	HRS No.	No. of contacts	ϕA	B	C	D	E	Remarks
JR21RK-10SC	114-0577-9	10	23.9	M26×1	27.6	32	26	Contact $\phi 1.6$
JR21RK-16PC	114-0578-1	16			25.4			
JR21RK-16SC	114-0579-4	24	27.9	M30×1	23	35	29	Contact $\phi 1$
JR25RK-24SC	114-0581-6							

● Threaded lock receptacle cap

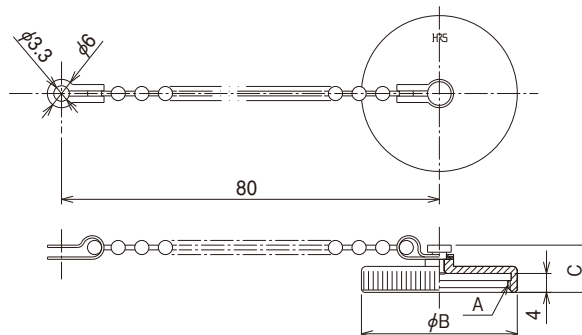

Part No.	HRS No.	A	ϕB	C	JIS No.
JRC13RC(71)	114-0053-8 71	M18×1	21	10	CNR01RC013
JRC16RC(71)	114-0054-0 71	M22×1	25		CNR01RC016
JRC21RC(71)	114-0055-3 71	M26×1	29		CNR01RC021
JRC25RC(71)	114-0056-6 71	M30×1	33		CNR01RC025

Dec.1.2018 Copyright 2018 HIROSE ELECTRIC CO., LTD. All Rights Reserved.

■ Solder Type

● Bayonet - lock plug

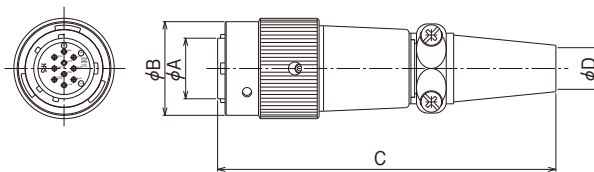

Part No.	HRS No.	No. of contacts	φA	φB	C	φD	Remarks
JRC16BP-14P(71)	114-0251-1 71	14	16.3	27	91	11.2	
JRC21BPA-26P(31)	114-0268-4 31	26	20.5	31	98	12.2	
JRC16BP-14S(71)	114-0254-0 71	14	16.3	27	91	11.2	
JRC21BP-26S(31)	114-0267-1 31	26	20.5	31	98	12.2	

● Bayonet - lock receptacle

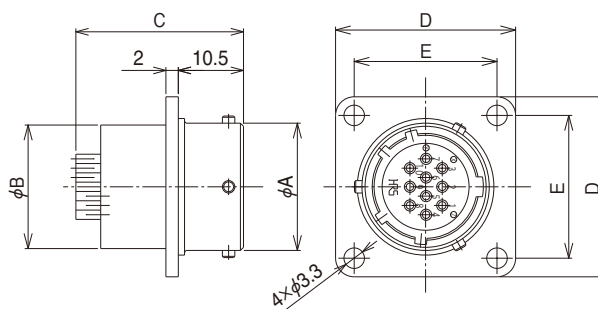

Part No.	HRS No.	No. of contacts	φA	φB	C	D	E	Remarks
JRC16BR-14P(71)	114-0257-8 71	14	20.5	19.9	26.6	29	23	
JRC21BR-26P(71)	114-0269-7 71	26	25.8	23.9	26.8	32	26	
JRC16BR-14S(71)	114-0260-2 71	14	20.5	19.9	25.8	29	23	
JRC21BRA-26S	114-0270-6	26	25.8	23.9	28	32	26	

◆ Crimp Contacts

Contact diameter $\phi 1.0\text{mm}$

Male contact

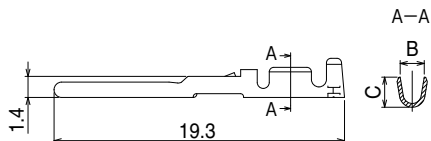

Type	Part No.	HRS No.	B	C	Applicable wire
Loose contact	JRC-PC2-112	114-0243-3	1.6	2.0	20 to 24 AWG
	JRC-PC2-122	114-0244-6	1.45	1.5	24 to 28 AWG
Reel contact	JRC-PC2-212	114-0245-9	1.6	2.0	20 to 24 AWG
	JRC-PC2-222	114-0246-1	1.45	1.5	24 to 28 AWG

Female contact

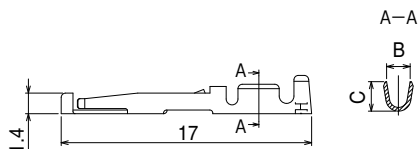

Type	Part No.	HRS No.	B	C	Applicable wire
Loose contact	JRC-SC2-112	114-0247-4	1.6	2.0	20 to 24 AWG
	JRC-SC2-122	114-0248-7	1.45	1.5	24 to 28 AWG
Reel contact	JRC-SC2-212	114-0249-0	1.6	2.0	20 to 24 AWG
	JRC-SC2-222	114-0250-9	1.45	1.5	24 to 28 AWG

Note : Loose contact in pack of 100 pcs. Reel contact contains 8,000 pcs.

Contact diameter $\phi 1.6\text{mm}$

Male contact

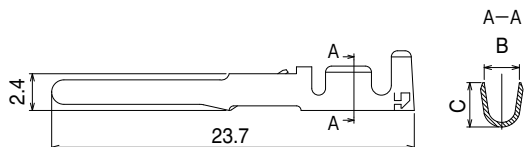

Type	Part No.	HRS No.	B	C	Applicable wire
Loose contact	JRC-PC-112	114-0239-6	2.3	2.9	16 to 20 AWG
Reel contact	JRC-PC-212	114-0240-5			

Female contact

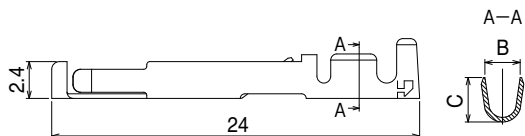

Type	Part No.	HRS No.	B	C	Applicable wire
Loose contact	JRC-SC-112	114-0241-8	2.3	2.9	16 to 20 AWG
Reel contact	JRC-SC-212	114-0242-0			

Note : Loose contact in pack of 100 pcs. Reel contact contains 5,000 pcs.

◆ **Applicable Tools**

Contact dia.	Type	Item	Part No.	HRS No.	Applicable terminal	Applicable wire
φ1	Manual	Manual crimping tool	HT802/RM-11	150-0401-6	JRC-PC2-112 JRC-SC2-112	20 to 24 AWG
			HT802/RM-12	150-0402-9	JRC-PC2-122 JRC-SC2-122	24 to 28 AWG
	Automatic	Automatic crimping press	CM-105C	901-0001-0	—————	—————
			Applicator	AP105-JRC2-1	901-2037-1	JRC-PC2-212 JRC-SC2-212
		AP105-JRC2-2		901-2038-4	JRC-PC2-222 JRC-SC2-222	24 to 28 AWG
	Extraction tool		RM-TP	150-0008-7	—————	—————
φ1.6	Manual	Manual crimping tool	JRC-TC-11	150-0033-4	JRC-PC-112 JRC-SC-112	16 AWG
			JRC-TC-12	150-0034-7	JRC-PC-112 JRC-SC-112	18 to 20 AWG
	Automatic	Automatic crimping press	CM-105C	901-0001-0	—————	—————
			Applicator	AP105-JRC-1	901-2039-7	JRC-PC-212 JRC-SC-212
	Extraction tool		JRC-TP	150-0035-0	—————	—————

Hand Tool Crimp



(For Contact Diameter φ1.0mm)



(For Contact Diameter φ1.6mm)

Extraction Tool



(For Contact Diameter φ1.0mm)



(For Contact Diameter φ1.6mm)



Automatic Crimping Machine CM-105C

◆ **Precautions**

This product series uses silver plated contacts. Silver reacts easily to exposure to sulfur gas so the below conditions may cause tarnishing.

- Dusty environments
- Area with a high concentration area of gases such as sulfur dioxide gas, hydrogen sulfide gas, nitrogen dioxide gas and so on. Example; In close proximity to factory exhaust, automotive emissions, etc.
- Close to heaters, or in other areas marked by extreme temperature differences or high humidity.
- Close to rubber products includes rubber adhesives.

The Electrical connection is not affected by tarnishing on a silver surface due to the wiping effect of the contact pins.

Storage

Packing state; Packed in original packing or equivalent container

Temperature -10 to +60°C

Humidity 85% Max

(It is recommended that the product be stored in an area of normal level of temperature and humidity, and free of any temperature fluctuation)

Please use this products within 6 months of delivery.

(After 6 month, please check the solderbility before use)

“Storage” means long-term storage of the unused products in sealed packaging, prior to assembly to PCB.

◆ Contact Position Arrangement

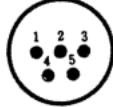
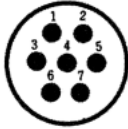
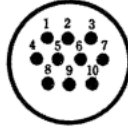
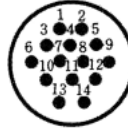
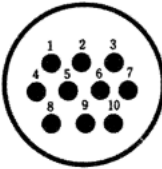
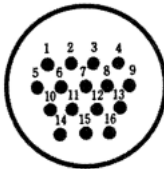
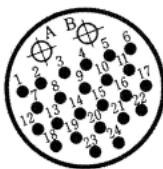
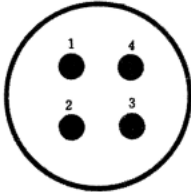
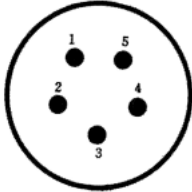
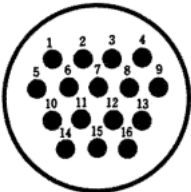
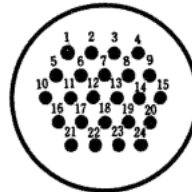
Shell size					
No. of contacts	3		5		
Withstanding voltage	AC1000V a minute				
Current rating	10A		5A		
Insulation resistance	1000MΩ MIN.				
Contact resistance	5mΩ MAX.				
Solderpot inner diameter	1.7mm dia.		1.1mm dia.		
Shell size					
No. of contacts	7		10		14
Withstanding voltage	AC1000V a minute				
Current rating	10A		5A		
Insulation resistance	1000MΩ MIN.				
Contact resistance	5mΩ MAX.				
Solderpot inner diameter	1.7mm dia.		1.1mm dia.		
Shell size					
No. of contacts	10		16		26
Withstanding voltage	AC1000V a minute				
Current rating	10A		5A (crimp type 3A)	5A	10A (only A, B)
Insulation resistance	1000MΩ MIN.				
Contact resistance	5mΩ MAX.		5mΩ MAX. (crimp type 10mΩ)	5mΩ MAX.	
Solderpot inner diameter	1.7mm dia.		1.1mm dia.		1.7mm dia. (only A, B)
Shell size					
No. of contacts	4	5	16	24	
Withstanding voltage	AC3000V a minute		AC1000V a minute		
Current rating	30A	10A		5A (crimp type 3A)	
Insulation resistance	10,000MΩ MIN.		1000MΩ MIN.		
Contact resistance	5mΩ MAX.			5mΩ MAX. (crimp type 10mΩ)	
Solderpot inner diameter	3.4mm dia.	1.7mm dia.		1.1mm dia.	

Remarks : 1. Viewed from mating face.
2. The withstand voltage is the test value.



HIROSE ELECTRIC CO.,LTD.

2-6-3,Nakagawa Chuoh,Tsuzuki-Ku,Yokohama-Shi 224-8540,JAPAN
 TEL: +81-45-620-3526 Fax: +81-45-591-3726
<http://www.hirose.com>
<http://www.hirose-connectors.com>

Mouser Electronics

Authorized Distributor

Click to View Pricing, Inventory, Delivery & Lifecycle Information:

Hirose Electric:

[JRC25PC\(71\)](#) [JRC13RC\(71\)](#) [JRC16RC\(71\)](#) [JRC21RC\(71\)](#) [JRC25RC\(71\)](#) [JR-S](#) [JRC-PC-112](#) [JRC-PC-212](#) [JRC-SC-112](#) [JRC-PC2-112](#) [JRC-PC2-122](#) [JRC-PC2-212](#) [JRC-PC2-222](#) [JRC-SC2-112](#) [JRC-SC2-122](#) [JRC-SC2-212](#) [JRC-SC2-222](#) [JRC16BP-14P\(71\)](#) [JRC16BP-14S\(71\)](#) [JRC16BR-14P\(71\)](#) [JRC16BR-14S\(71\)](#) [JRC21BP-26S\(71\)](#) [JRC21BPA-26P\(71\)](#) [JRC21BR-26P\(71\)](#) [JRC21BRA-26S](#) [JRC21BA-26PS\(71\)](#) [JR13PK-3P\(71\)](#) [JR13PK-5P\(71\)](#) [JR16PK-7P\(71\)](#) [JR16PK-10P\(71\)](#) [JR21PK-10P\(71\)](#) [JR21PK-16P\(71\)](#) [JR25PK-16P\(71\)](#) [JR25PK-24P\(71\)](#) [JR13PK-3S\(71\)](#) [JR13PK-5S\(71\)](#) [JR16PK-7S\(71\)](#) [JR16PK-10S\(71\)](#) [JR21PK-10S\(71\)](#) [JR21PK-16S\(71\)](#) [JR25PK-16S\(71\)](#) [JR25PK-24S\(71\)](#) [JR13RK-3P](#) [JR13RK-5P](#) [JR16RK-7P](#) [JR16RK-10P](#) [JR21RK-10P](#) [JR21RK-16P](#) [JR25RK-16P](#) [JR25RK-24P](#) [JR13RK-3S](#) [JR13RK-5S](#) [JR16RK-7S](#) [JR16RK-10S](#) [JR21RK-10S](#) [JR21RK-16S](#) [JR25RK-16S](#) [JR25RK-24S](#) [JR13JK-3P](#) [JR13JK-5P](#) [JR16JK-7P](#) [JR16JK-10P](#) [JR21JK-10P](#) [JR21JK-16P](#) [JR25JK-16P](#) [JR25JK-24P](#) [JR13JK-3S](#) [JR13JK-5S](#) [JR16JK-7S](#) [JR16JK-10S](#) [JR21JK-10S](#) [JR21JK-16S](#) [JR25JK-24S](#) [JR25PK-4S\(71\)](#) [JR25PK-5P\(71\)](#) [JR25RK-4P\(71\)](#) [JR25RK-5S](#) [JR25RK-8S](#) [JR25JK-4P\(71\)](#) [JR25JK-4S](#) [JR21PK-10PC\(71\)](#) [JR21PK-10SC\(71\)](#) [JR21PK-16PC\(71\)](#) [JR21PK-16SC\(71\)](#) [JR25PK-24PC\(71\)](#) [JR25PK-24SC\(71\)](#) [JR21RK-10SC](#) [JR21RK-16PC](#) [JR21RK-16SC](#) [JR25RK-24PC](#) [JR25RK-24SC](#) [JR25RC\(71\)](#) [JRC16WPQ-CP10\(71\)](#) [JRC16WPQ-7S\(71\)](#) [JRC-TC-11](#) [JRC-TC-12](#) [JRC-TP](#) [JR25RH-4S](#) [JR25RH-4P](#) [JR25PH-4S](#)