

---

## 11.3-Gbps RATE-SELECTABLE LIMITING AMPLIFIER

---

### FEATURES

- Up to 11.3-Gbps Operation
- 2-Wire Digital Interface
- Digitally Selectable Input Bandwidth
- Adjustable LOS Threshold
- Digitally Selectable Output Voltage
- Digitally Selectable Output Pre-Emphasis
- Adjustable Input Threshold Voltage
- Low Power Consumption
- Input Offset Cancellation
- CML Data Outputs with On-Chip 50-Ω Back-Termination to VCC
- Single +3.3-V Supply

- Output Disable
- Surface Mount Small Footprint 3 mm × 3 mm 16-Pin RoHS compliant QFN Package

### APPLICATIONS

- 10-Gigabit Ethernet Optical Receivers
- 8x and 10x Fiber Channel Optical Receivers
- SONET OC-192/SDH-64 Optical Receivers
- SFP+ and XFP Transceiver Modules
- XENPAK, XPAK, X2 and 300-pin MSA Transponder Modules
- Cable Driver and Receiver

### DESCRIPTION

The ONET8501P is a high-speed, 3.3-V limiting amplifier for multiple fiber optic and copper cable applications with data rates from 2 Gbps up to 11.3 Gbps.

The device provides a two-wire serial interface which allows digital control of the bandwidth, output amplitude, output pre-emphasis, input threshold voltage (slice level) and the loss of signal assert level. Predetermined settings for bandwidth and LOS assert levels can also be selected with external rate selection pins.

The ONET8501P provides a gain of about 40dB which ensures a fully differential output swing for input signals as low as 10 mV<sub>pp</sub>. The output amplitude can be adjusted to 300 mV<sub>pp</sub>, 600 mV<sub>pp</sub>, or 900 mV<sub>pp</sub>. To compensate for frequency dependent loss of microstrips or striplines connected to the output of the device, programmable pre-emphasis is included in the output stage. A settable loss of signal detection and output disable are also provided.

The part, available in RoHS compliant small footprint 3 mm × 3 mm 16-pin QFN package, typically dissipates less than 160 mW and is characterized for operation from –40°C to 100°C.



Please be aware that an important notice concerning availability, standard warranty, and use in critical applications of Texas Instruments semiconductor products and disclaimers thereto appears at the end of this data sheet.



These devices have limited built-in ESD protection. The leads should be shorted together or the device placed in conductive foam during storage or handling to prevent electrostatic damage to the MOS gates.

### BLOCK DIAGRAM

A simplified block diagram of the ONET8501P is shown in Figure 1.

This compact, low power 11.3 Gbps limiting amplifier consists of a high-speed data path with offset cancellation block (DC feedback) combined with an analog settable input threshold adjust, a loss of signal detection block using 2 peak detectors, a two-wire interface with a control-logic block and a bandgap voltage reference and bias current generation block.

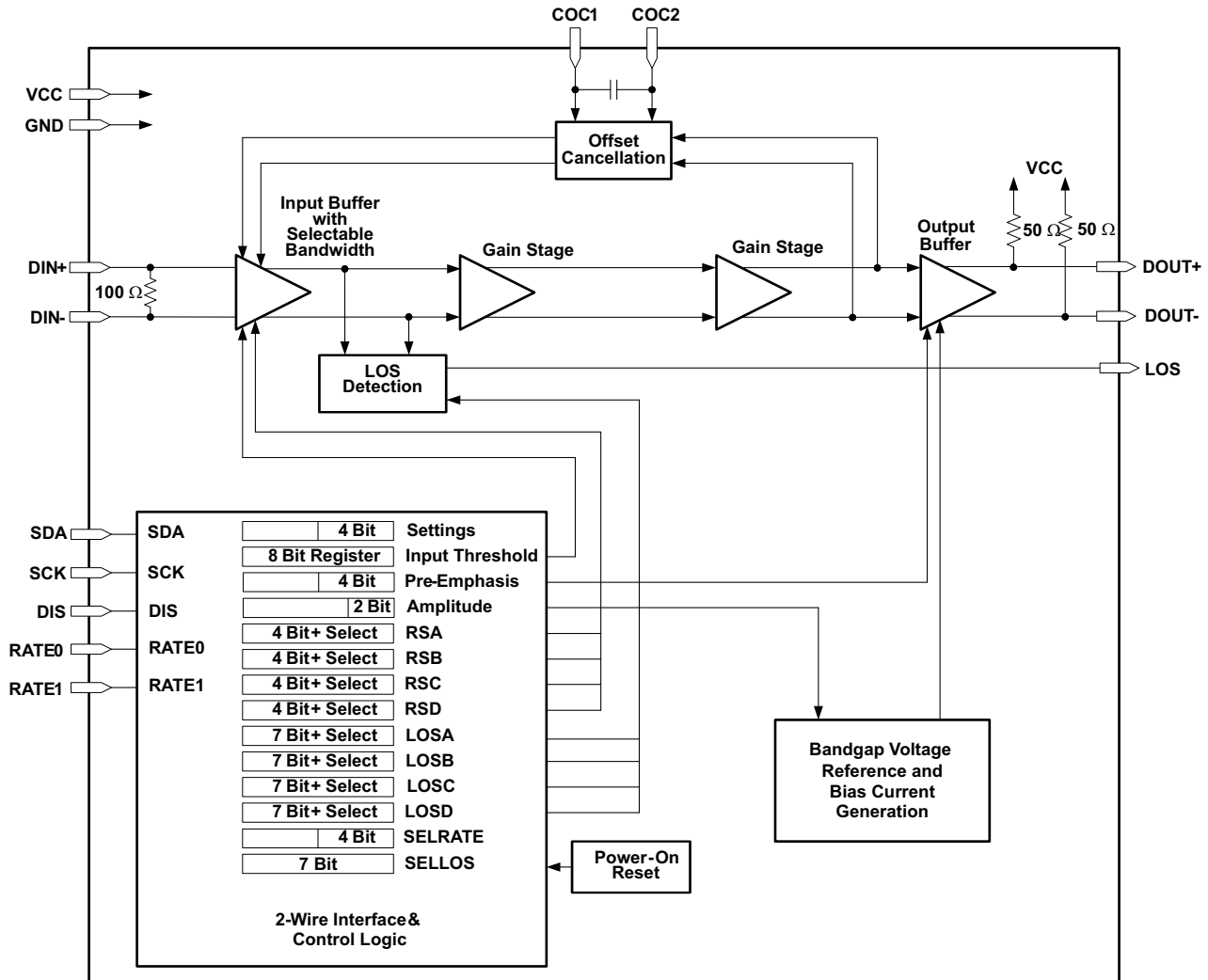
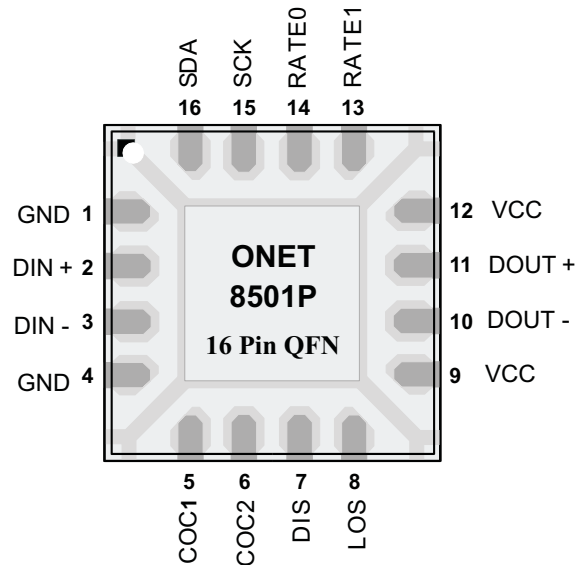

Figure 1. Simplified Block Diagram of the ONET8501P

## PACKAGE

The ONET8501P is available in a small footprint 3 mm × 3 mm 16-pin RoHS compliant QFN package with a lead pitch of 0,5 mm. The pin out is shown in Figure 2.



**Figure 2. Pinout of ONET8501P in a 3mm × 3mm 16-Pin QFN package (top view)**

## PIN DESCRIPTION

NO.	NAME	TYPE	DESCRIPTION
1,4, EP	GND	Supply	Circuit ground. Exposed die pad (EP) must be grounded.
2	DIN+	Analog-input	Non-inverted data input. Differentially 100 Ω terminated to DIN–.
3	DIN–	Analog-input	Inverted data input. Differentially 100 Ω terminated to DIN+.
5	COC1	Analog	Offset cancellation filter capacitor plus terminal. An external capacitor can be connected between this pin and COC2 to reduce the low frequency cutoff. To disable the offset cancellation loop, connect COC1 and COC2 together.
6	COC2	Analog	Offset cancellation filter capacitor minus terminal. An external capacitor can be connected between this pin and COC1 to reduce the low frequency cutoff. To disable the offset cancellation loop, connect COC1 and COC2 together.
7	DIS	Digital-input	Disables the output stage when set to a high level.
8	LOS	Open drain MOS	High level indicates that the input signal amplitude is below the programmed threshold level. Open drain output. Requires an external 10-kΩ pull-up resistor to VCC for proper operation.
9, 12	VCC	Supply	3.3-V ± 10% supply voltage.
10	DOUT–	CML-out	Inverted data output. On-chip 50 Ω back-terminated to VCC.
11	DOUT+	CML-out	Non-inverted data output. On-chip 50 Ω back-terminated to VCC.
13	RATE1	Digital-input	Bandwidth selection for noise suppression.
14	RATE0	Digital-input	Bandwidth selection for noise suppression.
15	SCK	Digital-input	Serial interface clock input. Connect a pull-up resistor (10 kΩ typical) to VCC.
16	SDA	Digital-input	Serial interface data input. Connect a pull-up resistor (10 kΩ typical) to VCC.

### ABSOLUTE MAXIMUM RATINGS<sup>(1)</sup>

over operating free-air temperature range (unless otherwise noted)

		VALUE	UNIT
$V_{CC}$	Supply voltage <sup>(2)</sup>	-0.3 to 4.0	V
$V_{DIN+}$ , $V_{DIN-}$	Voltage at DIN+, DIN- <sup>(2)</sup>	0.5 to 4.0	V
$V_{LOS}$ , $V_{COC1}$ , $V_{COC2}$ , $V_{DOUT+}$ , $V_{DOUT-}$ , $V_{DIS}$ , $V_{RATE0}$ , $V_{RATE1}$ , $V_{SDA}$ , $V_{SCK}$	Voltage at LOS, COC1, COC2, DOUT+, DOUT-, DIS, RATE0, RATE1, SDA, SCK <sup>(2)</sup>	-0.3 to 4.0	V
$V_{DIN,DIFF}$	Differential voltage between DIN+ and DIN-	±2.5	V
$I_{DIN+}$ , $I_{DIN-}$ , $I_{DOUT+}$ , $I_{DOUT-}$	Continuous current at inputs and outputs	25	mA
ESD	ESD rating at all pins	2	kV (HBM)
$T_{J,max}$	Maximum junction temperature	125	°C
$T_A$	Characterized free-air operating temperature range	-40 to 100	°C
$T_{STG}$	Storage temperature range	-65 to 150	°C
$T_{LEAD}$	Lead temperature 1.6mm (1/16 inch) from case for 10 seconds	260	°C

- (1) Stresses beyond those listed under *absolute maximum ratings* may cause permanent damage to the device. These are stress ratings only, and functional operation of the device at these or any other conditions beyond those indicated under *recommended operating conditions* is not implied. Device exposure to conditions outside the Absolute Maximum Ratings ranges for an extended duration can affect device reliability.
- (2) All voltage values are with respect to network ground terminal.

### RECOMMENDED OPERATING CONDITIONS

		MIN	TYP	MAX	UNIT
$V_{CC}$	Supply voltage	2.95	3.3	3.6	V
$T_A$	Operating free-air temperature	-40		100	°C
	DIGITAL input high voltage	2.0			V
	DIGITAL input low voltage			0.8	V

### DC ELECTRICAL CHARACTERISTICS

Over recommended operating conditions, outputs connected to a 50-Ω load, AMP1 = 0, AMP0 = 1 (Register 3) unless otherwise noted. Typical operating condition is at  $V_{CC} = 3.3$  V and  $T_A = 25$ °C

PARAMETER	TEST CONDITIONS	MIN	TYP	MAX	UNIT
$V_{CC}$	Supply voltage	2.95	3.3	3.6	V
$I_{VCC}$	Supply current DIS = 0, CML currents included		48	61	mA
$R_{IN}$	Data input resistance Differential		100		Ω
$R_{OUT}$	Data output resistance Single-ended, referenced to $V_{CC}$		50		Ω
	LOS HIGH voltage $I_{SOURCE} = 50$ μA with 10 kΩ pull-up to $V_{CC}$	2.4			
	LOS LOW voltage $I_{SINK} = 10$ mA with 10 kΩ pull-up to $V_{CC}$			0.4	V

## AC ELECTRICAL CHARACTERISTICS

Over recommended operating conditions, outputs connected to a 50-Ω load, AMP1 = 0, AMP0 = 1 (Register 3) and maximum bandwidth unless otherwise noted. Typical operating condition is at  $V_{CC} = 3.3\text{ V}$  and  $T_A = +25^\circ\text{C}$

PARAMETER		TEST CONDITION	MIN	TYP	MAX	UNIT
$f_{3dB-H}$	High frequency -3dB bandwidth		8.5	12.0		GHz
$f_{3dB-H}$	-3dB bandwidth default settings	RATE1 = 1, RATE0 = 0		11.0		GHz
		RATE1 = 1, RATE0 = 1		6.5		
		RATE1 = 0, RATE0 = 1		4.0		
		RATE1 = 0, RATE0 = 0		2.2		
$f_{3dB-L}$	Low frequency -3dB bandwidth	With 330-pF COC capacitor		20	45	kHz
$V_{IN,MIN}$	Data input sensitivity	K28.5 pattern at 11.3 Gbps, BER < $10^{-12}$		6	9	mV <sub>pp</sub>
		VOD-min $\geq 0.95 \cdot \text{VOD}$ (output limited)		8	20	
		K28.5 pattern at 8.5 Gbps, BER < $10^{-12}$ , RATE1 = 1, RATE0 = 0		5.5		
		K28.5 pattern at 4.25 Gbps, BER < $10^{-12}$ , RATE1 = 1, RATE0 = 1		5		
		K28.5 pattern at 2.125 Gbps, BER < $10^{-12}$ , RATE1 = 0, RATE0 = 1		5		
SDD11	Differential input return gain	0.01 GHz < f < 3.9 GHz		-16		dB
		3.9 GHz < f < 12.1 GHz		See <sup>(1)</sup>		
SDD22	Differential output return gain	0.01 GHz < f < 3.9 GHz		-16		dB
		3.9 GHz < f < 12.1 GHz		See <sup>(1)</sup>		
SCD11	Differential to common mode conversion gain	0.01 GHz < f < 12.1 GHz		-40		dB
SCC22	Common mode output return gain	0.01 GHz < f < 7.5 GHz		-13		dB
		7.5 GHz < f < 12.1 GHz		-9		
A	Small signal gain		35	40		dB
$V_{IN,MAX}$	Data input overload		2000			mV <sub>pp</sub>
DJ	Deterministic jitter at 11.3 Gbps	$V_{IN} = 5\text{ mV}_{pp}$ , K28.5 pattern		5	10	pS <sub>pp</sub>
		$V_{IN} = 20\text{ mV}_{pp}$ , K28.5 pattern		4	10	
		$V_{IN} = 2000\text{ mV}_{pp}$ , K28.5 pattern		5	15	
	Deterministic jitter at 8.5 Gbps	$V_{IN} = 20\text{ mV}_{pp}$ , K28.5 pattern, RATE1 = 1, RATE0 = 0		5		pS <sub>pp</sub>
	Deterministic jitter at 4.25 Gbps	$V_{IN} = 20\text{ mV}_{pp}$ , K28.5 pattern, RATE1 = 1, RATE0 = 1		6		pS <sub>pp</sub>
	Deterministic jitter at 2.125 Gbps	$V_{IN} = 20\text{ mV}_{pp}$ , K28.5 pattern, RATE1 = 0, RATE0 = 1		10		pS <sub>pp</sub>
RJ	Random jitter	$V_{IN} = 20\text{ mV}_{pp}$		1		pS <sub>rms</sub>
$V_{OD}$	Differential data output voltage	$V_{IN} > 20\text{ mV}_{pp}$ , DIS = 0, AMP1 = 0, AMP0 = 0	250	300	350	mV <sub>pp</sub>
		$V_{IN} > 20\text{ mV}_{pp}$ , DIS = 0, AMP1 = 0, AMP0 = 1	500	600	700	
		$V_{IN} > 20\text{ mV}_{pp}$ , DIS = 0, AMP1 = 1, AMP0 = 1	700	900	1100	
		DIS = 1			5	mV <sub>rms</sub>
$V_{PREEM}$	Output pre-emphasis step size			1		dB
$t_R$	Output rise time	20% to 80%, $V_{IN} > 20\text{mV}_{pp}$		25	35	ps
$t_F$	Output fall time	20% to 80%, $V_{IN} > 20\text{mV}_{pp}$		25	35	ps
$V_{TH}$	LOW LOS assert threshold range min	K28.5 pattern at 11.3 Gbps, LOSRNG = 0		15		mV <sub>pp</sub>
	LOW LOS assert threshold range max	K28.5 pattern at 11.3 Gbps, LOSRNG = 0		35		
$V_{TH}$	HIGH LOS assert threshold range min	K28.5 pattern at 11.3 Gbps, LOSRNG = 1		35		mV <sub>pp</sub>
	HIGH LOS assert threshold range max	K28.5 pattern at 11.3 Gbps, LOSRNG = 1		80		
	LOS threshold variation	Versus temperature at 11.3 Gbps		1.5		dB
		Versus supply voltage $V_{CC}$ at 11.3 Gbps		1		dB
		Versus data rate		1.5		dB
	LOS hysteresis (electrical)	K28.5 pattern at 11.3 Gbps	2	4	6	dB
$T_{LOS\_AST}$	LOS assert time		2.5	10	80	us
$T_{LOS\_DEA}$	LOS deassert time		2.5	10	80	us

(1) Differential return gain given by SDD11, SDD22 =  $-11.6 + 13.33 \log_{10}(f/8.25)$ , f expressed in GHz.

## AC ELECTRICAL CHARACTERISTICS (continued)

Over recommended operating conditions, outputs connected to a 50-Ω load, AMP1 = 0, AMP0 = 1 (Register 3) and maximum bandwidth unless otherwise noted. Typical operating condition is at  $V_{CC} = 3.3\text{ V}$  and  $T_A = +25^\circ\text{C}$

PARAMETER		TEST CONDITION	MIN	TYP	MAX	UNIT
$T_{Dis}$	Disable response time			20		ns

## DETAILED DESCRIPTION

### HIGH-SPEED DATA PATH

The high-speed data signal is applied to the data path by means of input signal pins DIN+/DIN-. The data path consists of a 100-Ω differential on-chip line termination resistor followed by a digitally controlled bandwidth switch input buffer for rate select. The RATE1 and RATE0 pins can be used to control the bandwidth of the filter. Default bandwidth settings are used; however, these can be changed using registers 4 through 7 via the serial interface. For details regarding the rate selection, see [Table 19](#). A gain stage and an output buffer stage follow the input buffer, which together provide a gain of 40dB. The device can accept input amplitude levels from 5 mV<sub>pp</sub> up to 2000 mV<sub>pp</sub>. The amplified data output signal is available at the output pins DOUT+/DOUT- which include on-chip 2 × 50-Ω back-termination to VCC.

Offset cancellation compensates for internal offset voltages and thus ensures proper operation even for very small input data signals. The offset cancellation can be disabled so that the input threshold voltage can be adjusted to optimize the bit error rate or change the eye crossing to compensate for input signal pulse width distortion. The offset cancellation can be disabled by setting OCDIS = 1 (bit 1 of register 0). The input threshold level can be adjusted using register settings THADJ[0..7] (register 1). For details regarding input threshold adjust, see [Table 19](#).

The low frequency cutoff is as low as 80 kHz with the built-in filter capacitor. For applications, which require even lower cutoff frequencies, an additional external filter capacitor may be connected to the COC1 and COC2 pins. A value of 330 pF results in a low frequency cutoff of 20 kHz.

### BANDGAP VOLTAGE AND BIAS GENERATION

The ONET8501P limiting amplifier is supplied by a single +3.3-V supply voltage connected to the VCC pins. This voltage is referred to ground (GND).

On-chip bandgap voltage circuitry generates a reference voltage, independent of supply voltage, from which all other internally required voltages and bias currents are derived.

### HIGH-SPEED OUTPUT BUFFER

The output amplitude of the buffer can be set to 300 mV<sub>pp</sub>, 600 mV<sub>pp</sub> or 900 mV<sub>pp</sub> using register settings AMP[0..1] (register 3) via the serial interface. To compensate for frequency dependant losses of transmission lines connected to the output, the ONET8501P has adjustable pre-emphasis of the output stage. The pre-emphasis can be set from 0 to 8 dB in 1 dB steps using register settings PEADJ[0..3] (register 2).

### RATE SELECT

There are 16 possible internal filter settings (4 bit) to adjust the small signal bandwidth to the data rate. For fast rate selection, 4 default values can be selected with the RATE1 and RATE0 pins. Using the serial interface, the bandwidth settings can be customized instead of using the default values. The default bandwidths and the registers used to change the bandwidth settings are shown in [Table 1](#).

**Table 1. Rate Selection Default Settings and Registers Used for Adjustment**

RATE1	RATE0	DEFAULT BANDWIDTH (GHz)	REGISTER USED FOR ADJUSTMENT
0	0	2.2	RSA (Register 4)
0	1	4.0	RSB (Register 5)
1	1	6.5	RSC (Register 6)
1	0	11.0	RSD (Register 7)

If the rate select register selection bit is set LOW, for example RSASEL = 0 (bit 7 of register 4), then the default bandwidth for that register is used. If the register selection bit is set HIGH, for example RSASEL = 1 (bit 7 of register 4), then the content of RSA[0..3] (register 4) is used to set the input filter bandwidth when RATE0 = 0 and RATE1 = 0. The settings of the rate selection registers RSA, RSB, RSC and RSD and the corresponding filter bandwidths are shown in [Table 2](#).

**Table 2. Available Bandwidth Settings**

RSX3	RSX2	RSX1	RSX0	TYPICAL BANDWIDTH (GHz)
0	0	0	0	12.0
0	0	0	1	11.5
0	0	1	0	11.0
0	0	1	1	10.0
0	1	0	0	8.6
0	1	0	1	6.5
0	1	1	0	5.2
0	1	1	1	4.3
1	0	0	0	4.0
1	0	0	1	3.7
1	0	1	0	3.3
1	0	1	1	2.9
1	1	0	0	2.7
1	1	0	1	2.5
1	1	1	0	2.3
1	1	1	1	2.2

The RATE1 and RATE0 pins do not have to be used if the serial interface is being used. If RATE1 is not connected it is internally pulled HIGH and if RATE0 is not connected it is internally pulled LOW, thus selecting register 7. Therefore, changing the contents of RSD[0..3] (register 7) through the serial interface can be used to adjust the bandwidth.

### LOSS OF SIGNAL DETECTION

The loss of signal detection is done by 2 separate level detectors to cover a wide dynamic range. The peak values of the input signal and the output signal of the gain stage are monitored by the peak detectors. The peak values are compared to a pre-defined loss of signal threshold voltage inside the loss of signal detection block. As a result of the comparison, the LOS signal, which indicates that the input signal amplitude is below the defined threshold level, is generated. The LOS assert level is settable through the serial interface. There are 2 LOS ranges settable with the LOSRNG bit (bit 2, register 0) via the serial interface. By setting the bit LOSRNG = 1, the high range of the LOS assert values are used (35 mV<sub>pp</sub> to 80 mV<sub>pp</sub>) and by setting the bit LOSRNG = 0, the low range of the LOS assert values are used (15 mV<sub>pp</sub> to 35 mV<sub>pp</sub>).

There are 128 possible internal LOS settings (7 bit) for each LOS range to adjust the LOS assert level. For fast LOS selection, 4 default values can be selected with the RATE1 and RATE0 pins; however, the LOS settings can be customized instead of using the default values. The default LOS assert levels and the registers used to change the LOS settings are shown in [Table 3](#).

**Table 3. LOS Assert Level Default Settings and Registers Used for Adjustment**

RATE1	RATE0	DEFAULT LOS ASSERT LEVEL (mV <sub>pp</sub> )	REGISTER USED FOR ADJUSTMENT
0	0	15	LOSA (Register 8)
0	1	18	LOSB (Register 9)
1	1	26	LOSC (Register 10)
1	0	26	LOSD (Register 11)

If the LOS register selection bit is set LOW, for example LOSASEL = 0 (bit 7, register 8), then the default LOS assert level for that register is used. If the register selection bit is set HIGH, for example LOSASEL = 1 (bit 7, register 8), then the content of LOSA[0..6] (register 8) is used to set the LOS assert level when RATE1 = 0 and RATE0 = 0. The RATE1 and RATE0 pins do not have to be used if the serial interface is being used. If RATE1 is not connected it is internally pulled HIGH and if RATE0 is not connected it is internally pulled LOW, thus selecting register 11. Therefore, changing the contents of LOSD[0..6] (register 11) through the serial interface can be used to adjust the LOS assert level.

## 2-WIRE INTERFACE AND CONTROL LOGIC

The ONET8501P uses a 2-wire serial interface for digital control. The two circuit inputs, SDA and SCK, are driven, respectively, by the serial data and serial clock from a microcontroller, for example. Both inputs include 100-k $\Omega$  pull-up resistors to VCC. For driving these inputs, an open drain output is recommended.

The 2-wire interface allows write access to the internal memory map to modify control registers and read access to read out control and status signals. The ONET8501P is a slave device only which means that it can not initiate a transmission itself; it always relies on the availability of the SCK signal for the duration of the transmission. The master device provides the clock signal as well as the START and STOP commands. The protocol for a data transmission is as follows:

1. START command
2. 7-bit slave address (1000100) followed by an eighth bit which is the data direction bit (R/W). A zero indicates a WRITE and a 1 indicates a READ.
3. 8-bit register address
4. 8-bit register data word
5. STOP command

Regarding timing, the ONET8501P is I<sup>2</sup>C compatible. The typical timing is shown in [Figure 3](#) and a complete data transfer is shown in [Figure 4](#). Parameters for [Figure 3](#) are defined in [Table 4](#).

**Bus Idle:** Both SDA and SCK lines remain HIGH

**Start Data Transfer:** A change in the state of the SDA line, from HIGH to LOW, while the SCK line is HIGH, defines a START condition (S). Each data transfer begins with a START condition.

**Stop Data Transfer:** A change in the state of the SDA line from LOW to HIGH while the SCK line is HIGH defines a STOP condition (P). Each data transfer ends with a STOP condition; however, if the master still wishes to communicate on the bus, it can generate a repeated START condition and address another slave without first generating a STOP condition.

**Data Transfer:** Only one data byte can be transferred between a START and a STOP condition. The receiver acknowledges the transfer of data.

**Acknowledge:** Each receiving device, when addressed, is obliged to generate an acknowledgment bit. The transmitter releases the SDA line and a device that acknowledges, must pull down the SDA line during the acknowledge clock pulse simultaneously so the SDA line is stable LOW during the HIGH period of the acknowledge clock pulse. Set-up and hold times must be taken into account. When a slave-receiver fails to acknowledge the slave address, the data line must be left HIGH by the slave. The master can generate a STOP condition to prevent the transfer. If the slave-receiver does acknowledge the slave address but some time later in the transfer cannot receive any more data bytes, the master must cancel the transfer. This is indicated by the slave generating the not acknowledge on the first following byte. The slave leaves the data line HIGH and the master generates the STOP condition.



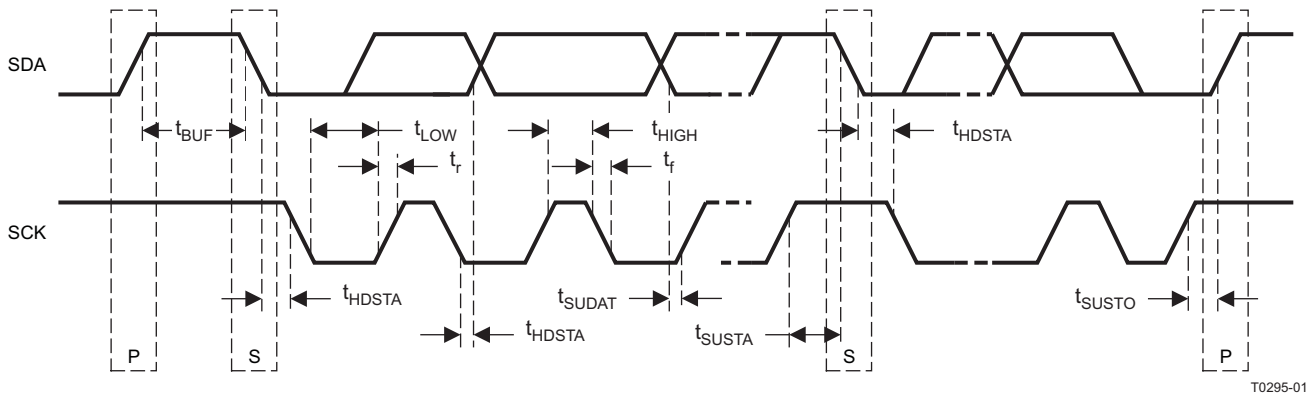

Figure 3. I<sup>2</sup>C Timing Diagram

Table 4. Timing Diagram Definitions

PARAMETER		MIN	MAX	UNIT
$f_{SCK}$	SCK clock frequency		400	kHz
$t_{BUF}$	Bus free time between START and STOP conditions	1.3		$\mu$ s
$t_{HDSTA}$	Hold time after repeated START condition. After this period, the first clock pulse is generated	0.6		$\mu$ s
$t_{LOW}$	Low period of the SCK clock	1.3		$\mu$ s
$t_{HIGH}$	High period of the SCK clock	0.6		$\mu$ s
$t_{SUSTA}$	Setup time for a repeated START condition	0.6		$\mu$ s
$t_{HDDAT}$	Data HOLD time	0		$\mu$ s
$t_{SUDAT}$	Data setup time	100		ns
$t_R$	Rise time of both SDA and SCK signals		300	ns
$t_F$	Fall time of both SDA and SCK signals		300	ns
$t_{SUSTO}$	Setup time for STOP condition	0.6		$\mu$ s

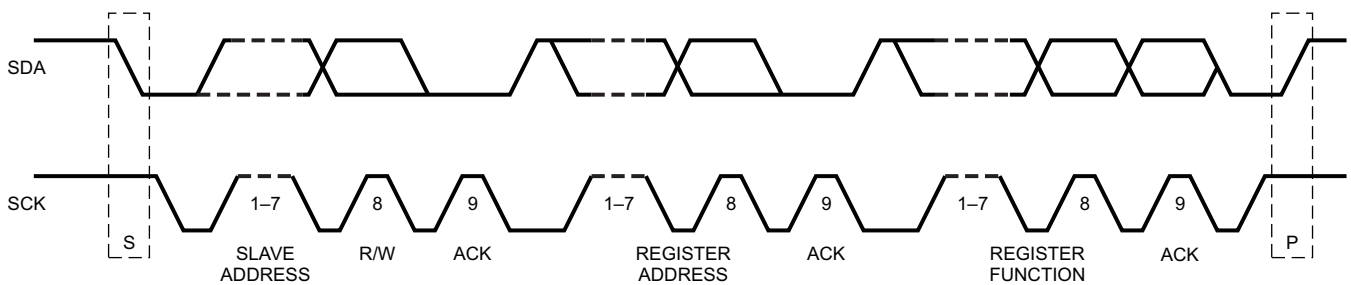

Figure 4. I<sup>2</sup>C Data Transfer

## REGISTER MAPPING

The register mapping for read/write register addresses 0 (0x00) through 11 (0x0B) are shown in [Table 5](#) through [Table 16](#). The register mapping for the read only register addresses 14 (0x0E) and 15 (0x0F) are shown in [Table 17](#) and [Table 18](#).

[Table 19](#) describes the circuit functionality based on the register settings.

**Table 5. Register 0 (0x00) Mapping – Control Settings**

register address 0 (0x00)							
bit 7	bit 6	bit 5	bit4	bit 3	bit 2	bit 1	bit 0
–	–	–	–	DIS	LOSRNG	OCDIS	I2CDIS

**Table 6. Register 1 (0x01) Mapping – Input Threshold Adjust**

register address 1 (0x01)							
bit 7	bit 6	bit 5	bit4	bit 3	bit 2	bit 1	bit 0
THADJ7	THADJ6	THADJ5	THADJ4	THADJ3	THADJ2	THADJ1	THADJ0

**Table 7. Register 2 (0x02) Mapping – Pre-emphasis Adjust**

register address 2 (0x02)							
bit 7	bit 6	bit 5	bit4	bit 3	bit 2	bit 1	bit 0
–	–	–	–	PEADJ3	PEADJ2	PEADJ1	PEADJ0

**Table 8. Register 3 (0x03) Mapping – Output Amplitude Adjust**

register address 3 (0x03)							
bit 7	bit 6	bit 5	bit4	bit 3	bit 2	bit 1	bit 0
–	–	–	–	–	–	AMP1	AMP0

**Table 9. Register 4 (0x04) Mapping – Rate Selection Register A**

register address 4 (0x04)							
bit 7	bit 6	bit 5	bit4	bit 3	bit 2	bit 1	bit 0
RSASEL	–	–	–	RSA3	RSA2	RSA1	RSA0

**Table 10. Register 5 (0x05) Mapping – Rate Selection Register B**

register address 5 (0x05)							
bit 7	bit 6	bit 5	bit4	bit 3	bit 2	bit 1	bit 0
RSBSEL	–	–	–	RSB3	RSB2	RSB1	RSB0

**Table 11. Register 6 (0x06) Mapping – Rate Selection Register C**

register address 6 (0x06)							
bit 7	bit 6	bit 5	bit4	bit 3	bit 2	bit 1	bit 0
RSCSEL	–	–	–	RSC3	RSC2	RSC1	RSC0

**Table 12. Register 7 (0x07) Mapping – Rate Selection Register D**

register address 7 (0x07)							
bit 7	bit 6	bit 5	bit4	bit 3	bit 2	bit 1	bit 0
RSDSEL	–	–	–	RSD3	RSD2	RSD1	RSD0

**Table 13. Register 8 (0x08) Mapping – LOS Assert Level Register A**

register address 8 (0x08)							
bit 7	bit 6	bit 5	bit4	bit 3	bit 2	bit 1	bit 0
LOSASEL	LOSA6	LOSA5	LOSA4	LOSA3	LOSA2	LOSA1	LOSA0

**Table 14. Register 9 (0x09) Mapping – LOS Assert Level Register B**

register address 9 (0x09)							
bit 7	bit 6	bit 5	bit4	bit 3	bit 2	bit 1	bit 0
LOSBSSEL	LOS6	LOS5	LOS4	LOS3	LOS2	LOS1	LOS0

**Table 15. Register 10 (0x0A) Mapping – LOS Assert Level Register C**

register address 10 (0x0A)							
bit 7	bit 6	bit 5	bit4	bit 3	bit 2	bit 1	bit 0
LOSCSEL	LOSC6	LOSC5	LOSC4	LOSC3	LOSC2	LOSC1	LOSC0

**Table 16. Register 11 (0x0B) Mapping – LOS Assert Level Register D**

register address 11 (0x0B)							
bit 7	bit 6	bit 5	bit4	bit 3	bit 2	bit 1	bit 0
LODSEL	LOD6	LOD5	LOD4	LOD3	LOD2	LOD1	LOD0

**Table 17. Register 14 (0x0E) Mapping – Selected Rate Setting (Read Only)**

register address 14 (0x0E)							
bit 7	bit 6	bit 5	bit4	bit 3	bit 2	bit 1	bit 0
–	–	–	–	SELRATE3	SELRATE2	SELRATE1	SELRATE0

**Table 18. Register 15 (0x0F) Mapping – Selected LOS Level (Read Only)**

register address 15 (0x0F)							
bit 7	bit 6	bit 5	bit4	bit 3	bit 2	bit 1	bit 0
–	SELLOS6	SELLOS5	SELLOS4	SELLOS3	SELLOS2	SELLOS1	SELLOS0

**Table 19. Register Functionality**

SYMBOL	REGISTER BIT	FUNCTION
DIS	Output disable bit 3	<b>Output disable bit:</b> 1 = output disabled 0 = output enabled
LOSRNG	LOS Range bit 2	<b>LOS range bit:</b> 1 = high LOS assert voltage range 0 = low LOS assert voltage range
OCDIS	Offset cancellation disable bit 1	<b>Offset cancellation disable bit:</b> 1 = offset cancellation is disabled 0 = offset cancellation is enabled
I2CDIS	I <sup>2</sup> C disable bit 0	<b>I<sup>2</sup>C disable bit:</b> 1 = I <sup>2</sup> C is disabled. 0 = I <sup>2</sup> C is enabled. This is the default setting.
THADJ7	Input threshold adjust bit 7 (MSB)	<b>Input threshold adjustment setting:</b> Maximum positive shift for 00000001 (1) Minimum positive shift for 01111111 (127) Zero shift for 10000000 (128) Minimum negative shift for 10000001 (129) Maximum negative shift for 11111111 (255)
THADJ6	Input threshold adjust bit 6	
THADJ5	Input threshold adjust bit 5	
THADJ4	Input threshold adjust bit 4	
THADJ3	Input threshold adjust bit 3	
THADJ2	Input threshold adjust bit 2	
THADJ1	Input threshold adjust bit 1	
THADJ0	Input threshold adjust bit 0 (LSB)	

**Table 19. Register Functionality (continued)**

SYMBOL	REGISTER BIT	FUNCTION																					
PEADJ3	Pre-emphasis adjust bit 3 (MSB)	<b>Pre-emphasis setting:</b> <table border="1"> <thead> <tr> <th>Pre-emphasis (dB)</th> <th>Register Setting</th> </tr> </thead> <tbody> <tr><td>0</td><td>0000</td></tr> <tr><td>1</td><td>0001</td></tr> <tr><td>2</td><td>0011</td></tr> <tr><td>3</td><td>0100</td></tr> <tr><td>4</td><td>0101</td></tr> <tr><td>5</td><td>0111</td></tr> <tr><td>6</td><td>1100</td></tr> <tr><td>7</td><td>1101</td></tr> <tr><td>8</td><td>1111</td></tr> </tbody> </table>		Pre-emphasis (dB)	Register Setting	0	0000	1	0001	2	0011	3	0100	4	0101	5	0111	6	1100	7	1101	8	1111
Pre-emphasis (dB)	Register Setting																						
0	0000																						
1	0001																						
2	0011																						
3	0100																						
4	0101																						
5	0111																						
6	1100																						
7	1101																						
8	1111																						
PEADJ2	Pre-emphasis adjust bit 2																						
PEADJ1	Pre-emphasis adjust bit 1																						
PEADJ0	Pre-emphasis adjust bit 0 (LSB)																						
AMP1	Output amplitude adjustment bit 1	<b>Output amplitude adjustment:</b> 00 = 300 mV <sub>pp</sub> 01 = 600 mV <sub>pp</sub> 10 = 600 mV <sub>pp</sub> 11 = 900 mV <sub>pp</sub>																					
AMP0	Output amplitude adjustment bit 0																						
RSASEL	Register RSA select bit 7 (MSB)	<b>Rate selection register A</b> RSASEL = 1 Content of register A bits 3 to 0 is used to select the input filter BW RSASEL = 0 Default BW of 2.2 GHz is used Register RSA is used when RATE1 = 0 and RATE0 = 0																					
–																							
–																							
–																							
RSA3	Rate select register A bit 3																						
RSA2	Rate select register A bit 2																						
RSA1	Rate select register A bit 1																						
RSA0	Rate select register A bit 0 (LSB)																						
RSBSEL	Register RSA select bit 7 (MSB)	<b>Rate selection register B</b> RSBSEL = 1 Content of register B bits 3 to 0 is used to select the input filter BW RSBSEL = 0 Default BW of 4.0 GHz is used Register RSB is used when RATE1 = 0 and RATE0 = 1																					
–																							
–																							
–																							
RSB3	Rate select register B bit 3																						
RSB2	Rate select register B bit 2																						
RSB1	Rate select register B bit 1																						
RSB0	Rate select register B bit 0 (LSB)																						
RSCSEL	Register RSA select bit 7 (MSB)	<b>Rate selection register C</b> RSCSEL = 1 Content of register C bits 3 to 0 is used to select the input filter BW RSCSEL = 0 Default BW of 6.5GHz is used Register RSC is used when RATE1 = 1 and RATE0 = 1																					
–																							
–																							
–																							
RSC3	Rate select register C bit 3																						
RSC2	Rate select register C bit 2																						
RSC1	Rate select register C bit 1																						
RSC0	Rate select register C bit 0 (LSB)																						

**Table 19. Register Functionality (continued)**

SYMBOL	REGISTER BIT	FUNCTION
RSDSEL	Register RSD select bit 7 (MSB)	<b>Rate selection register D</b> RSDSEL = 1 Content of register D bits 3 to 0 is used to select the input filter BW RSDSEL = 0 Default BW of 11.0 GHz is used
–		
–		
–		
RSD3	Rate select register D bit 3	
RSD2	Rate select register D bit 2	
RSD1	Rate select register D bit 1	
RSD0	Rate select register D bit 0 (LSB)	Register RSD is used when RATE1 = 1 and RATE0 = 0 or RATE1 and RATE0 are not connected
LOSASEL	Register LOSA select bit 7 (MSB)	<b>LOS assert level register A</b> LOSASEL = 1 Content of register A bits 6 to 0 is used to select the LOS assert level Minimum LOS assert level for 0000000 Maximum LOS assert level for 1111111 LOSASEL = 0 Default LOS assert level of 15 mVpp is used Register LOSA is used when RATE1 = 0 and RATE0 = 0
LOSA6	LOS assert level register A bit 6	
LOSA5	LOS assert level register A bit 5	
LOSA4	LOS assert level register A bit 4	
LOSA3	LOS assert level register A bit 3	
LOSA2	LOS assert level register A bit 2	
LOSA1	LOS assert level register A bit 1	
LOSA0	LOS assert level register A bit 0 (LSB)	
LOSBSEL	Register LOSB select bit 7 (MSB)	<b>LOS assert level register B</b> LOSBSEL = 1 Content of register B bits 6 to 0 is used to select the LOS assert level Minimum LOS assert level for 0000000 Maximum LOS assert level for 1111111 LOSBSEL = 0 Default LOS assert level of 18 mVpp is used Register LOSB is used when RATE1 = 0 and RATE0 = 1
LOSB6	LOS assert level register B bit 6	
LOSB5	LOS assert level register B bit 5	
LOSB4	LOS assert level register B bit 4	
LOSB3	LOS assert level register B bit 3	
LOSB2	LOS assert level register B bit 2	
LOSB1	LOS assert level register B bit 1	
LOSB0	LOS assert level register B bit 0 (LSB)	
LOSCSEL	Register LOSC select bit 7 (MSB)	<b>LOS assert level register C</b> LOSCSEL = 1 Content of register C bits 6 to 0 is used to select the LOS assert level Minimum LOS assert level for 0000000 Maximum LOS assert level for 1111111 LOSCSEL = 0 Default LOS assert level of 26 mVpp is used Register LOSC is used when RATE1 = 1 and RATE0 = 1
LOSC6	LOS assert level register C bit 6	
LOSC5	LOS assert level register C bit 5	
LOSC4	LOS assert level register C bit 4	
LOSC3	LOS assert level register C bit 3	
LOSC2	LOS assert level register C bit 2	
LOSC1	LOS assert level register C bit 1	
LOSC0	LOS assert level register C bit 0 (LSB)	
LODSEL	Register LODS select bit 7 (MSB)	<b>LOS assert level register D</b> LODSEL = 1 Content of register D bits 6 to 0 is used to select the LOS assert level Minimum LOS assert level for 0000000 Maximum LOS assert level for 1111111 LODSEL = 0 Default LOS assert level of 26 mVpp is used Register LODS is used when RATE1 = 1 and RATE0 = 0 or RATE1 and RATE0 are not connected
LOD6	LOS assert level register D bit 6	
LOD5	LOS assert level register D bit 5	
LOD4	LOS assert level register D bit 4	
LOD3	LOS assert level register D bit 3	
LOD2	LOS assert level register D bit 2	
LOD1	LOS assert level register D bit 1	
LOD0	LOS assert level register D bit 0 (LSB)	
SELRATE3	Selected rate setting bit 3	<b>Selected rate setting (read only)</b>
SELRATE2	Selected rate setting bit 2	
SELRATE1	Selected rate setting bit 1	
SELRATE0	Selected rate setting bit 0	

**Table 19. Register Functionality (continued)**

SYMBOL	REGISTER BIT	FUNCTION
SELLOS6	Selected LOS assert level bit 6 (MSB)	Selected LOS assert level (read only)
SELLOS5	Selected LOS assert level bit 5	
SELLOS4	Selected LOS assert level bit 4	
SELLOS3	Selected LOS assert level bit 3	
SELLOS2	Selected LOS assert level bit 2	
SELLOS1	Selected LOS assert level bit 1	
SELLOS0	Selected LOS assert level bit 0 (LSB)	

**TYPICAL OPERATION CHARACTERISTICS**

Typical operating condition is at  $V_{CC} = 3.3\text{ V}$ ,  $T_A = 25^\circ\text{C}$ , AMP1 = 0, AMP0 = 1 (Register 3) and maximum bandwidth unless otherwise noted.

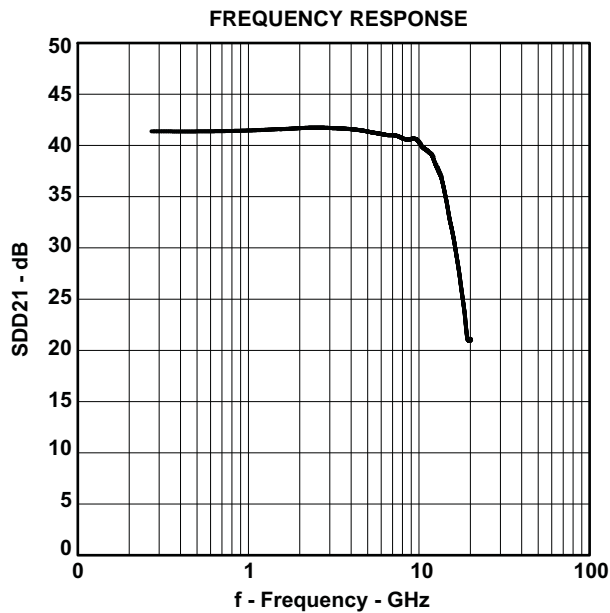

Figure 5.

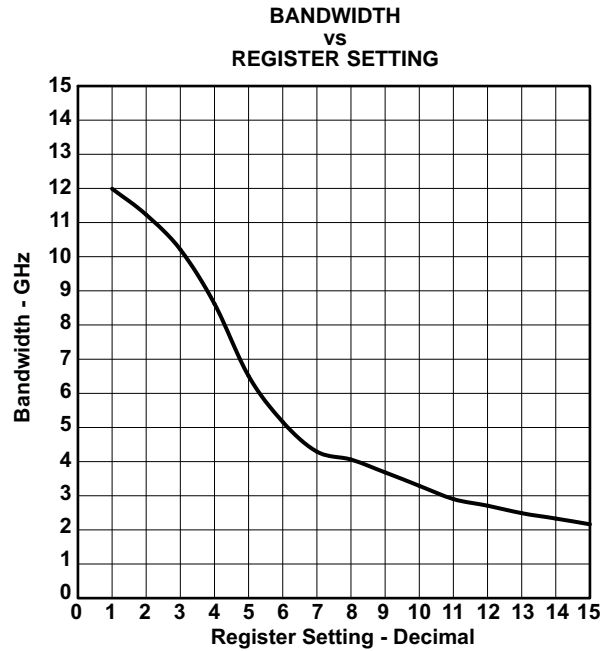

Figure 6.

**TYPICAL OPERATION CHARACTERISTICS (continued)**

Typical operating condition is at  $V_{CC} = 3.3\text{ V}$ ,  $T_A = 25^\circ\text{C}$ , AMP1 = 0, AMP0 = 1 (Register 3) and maximum bandwidth unless otherwise noted.

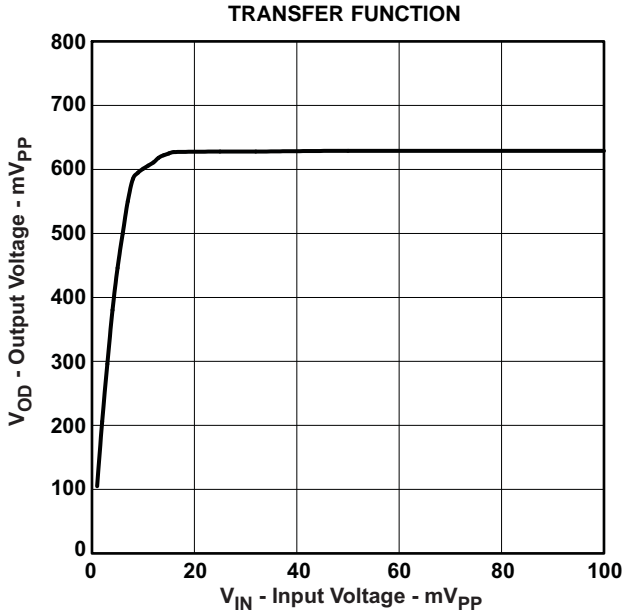

Figure 7.

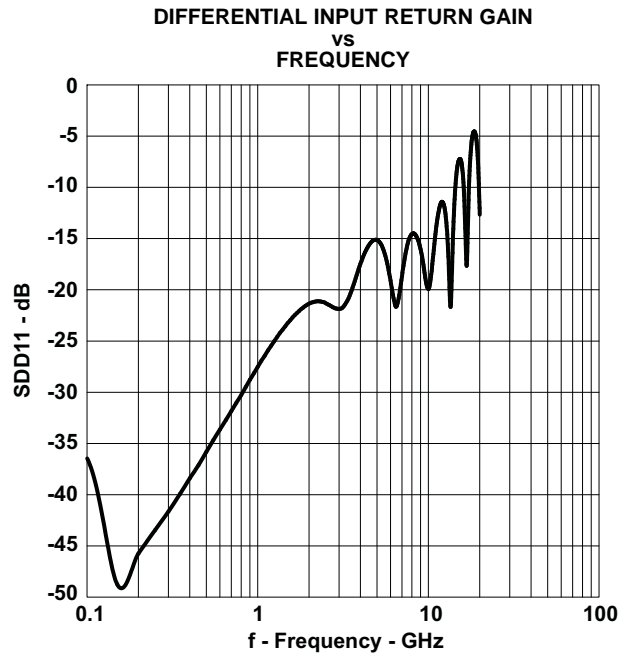

Figure 8.

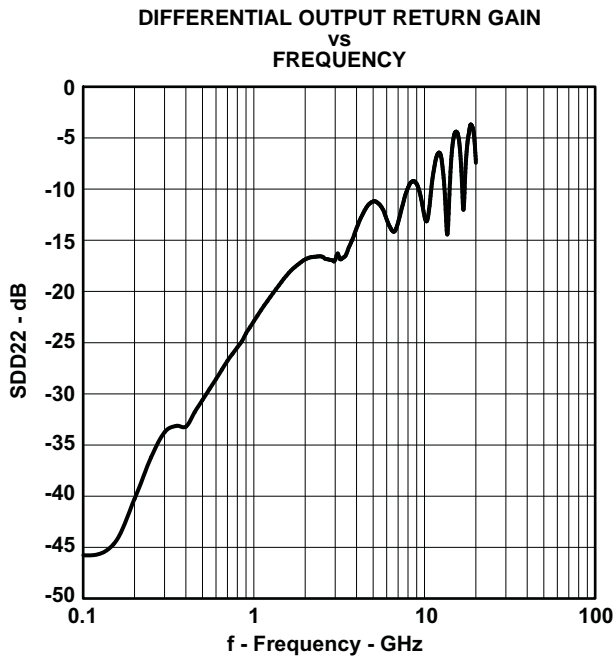

Figure 9.

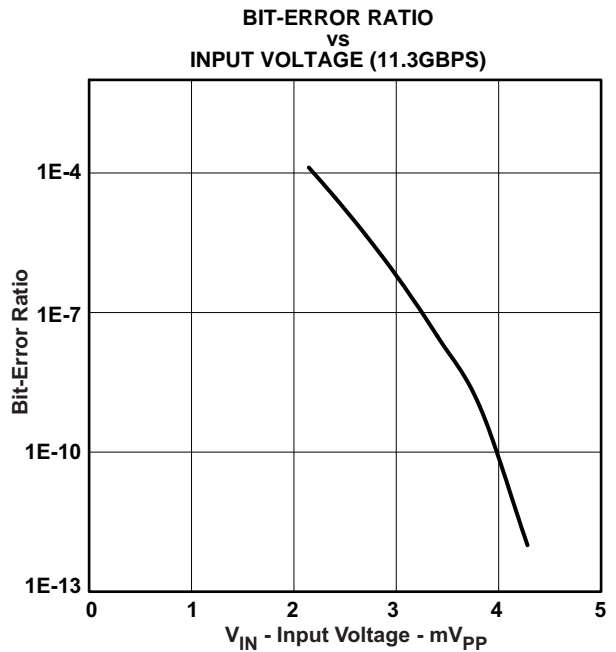

Figure 10.

TYPICAL OPERATION CHARACTERISTICS (continued)

Typical operating condition is at  $V_{CC} = 3.3\text{ V}$ ,  $T_A = 25^\circ\text{C}$ , AMP1 = 0, AMP0 = 1 (Register 3) and maximum bandwidth unless otherwise noted.

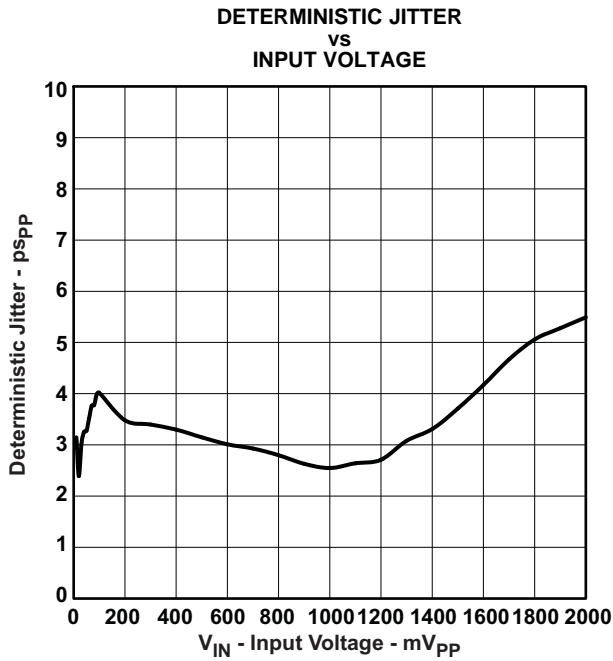

Figure 11.

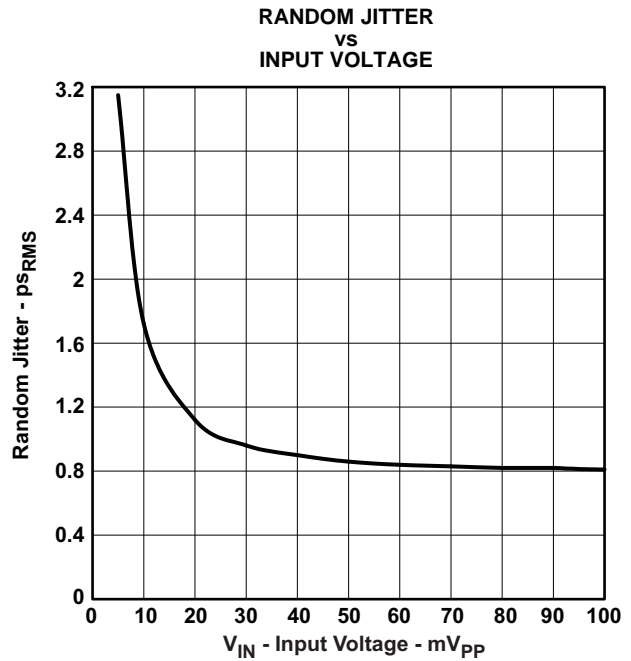

Figure 12.

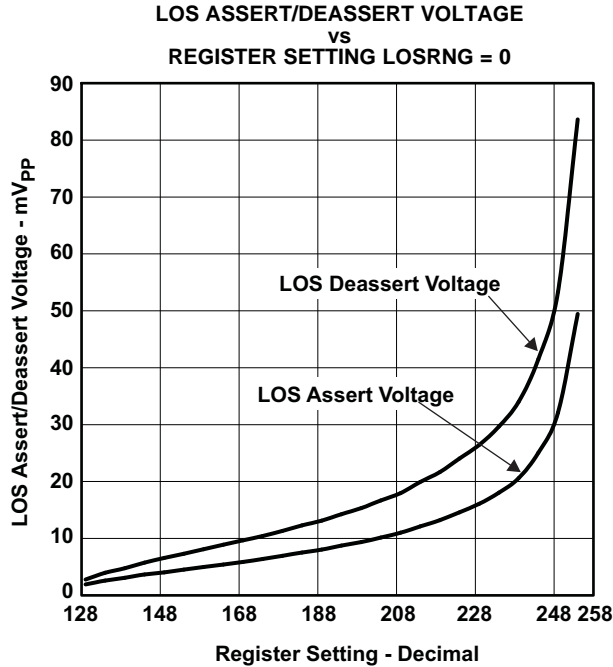

Figure 13.

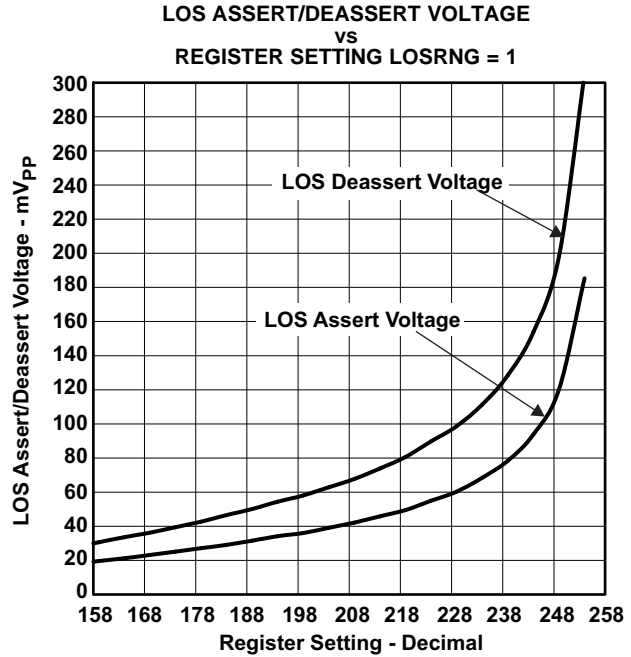

Figure 14.



**TYPICAL OPERATION CHARACTERISTICS (continued)**

Typical operating condition is at  $V_{CC} = 3.3\text{ V}$ ,  $T_A = 25^\circ\text{C}$ , AMP1 = 0, AMP0 = 1 (Register 3) and maximum bandwidth unless otherwise noted.

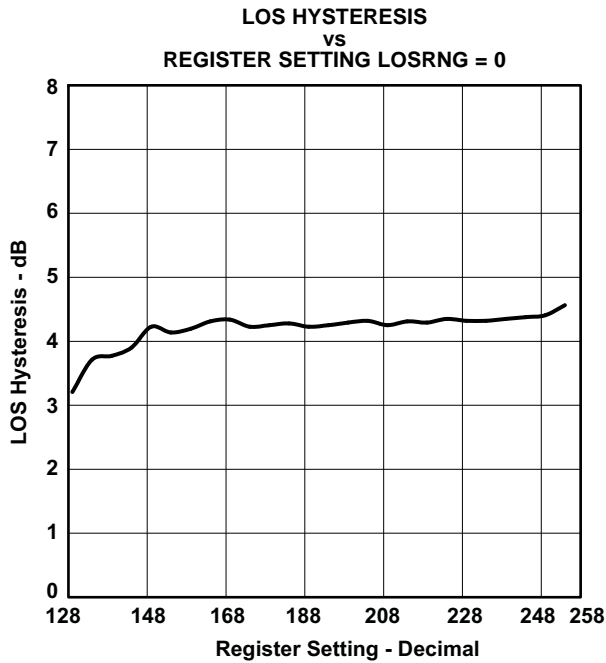

Figure 15.

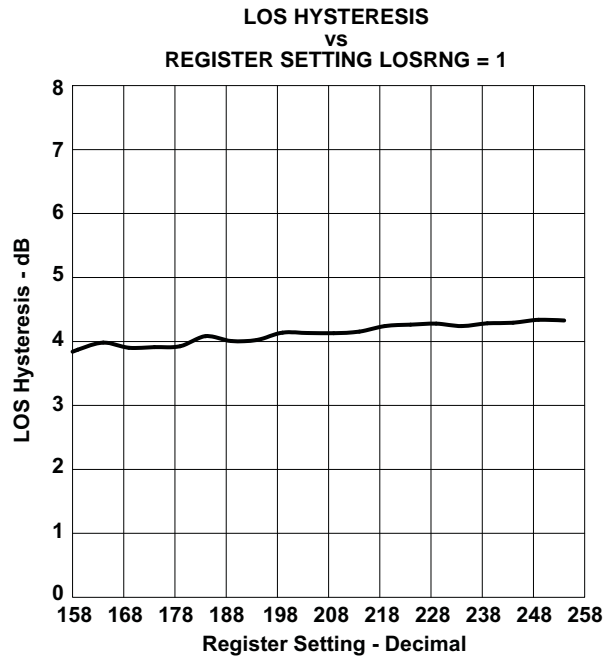

Figure 16.

**OUTPUT EYE-DIAGRAM AT 10.3 GBPS  
AND MINIMUM INPUT VOLTAGE (10 mV<sub>PP</sub>)**

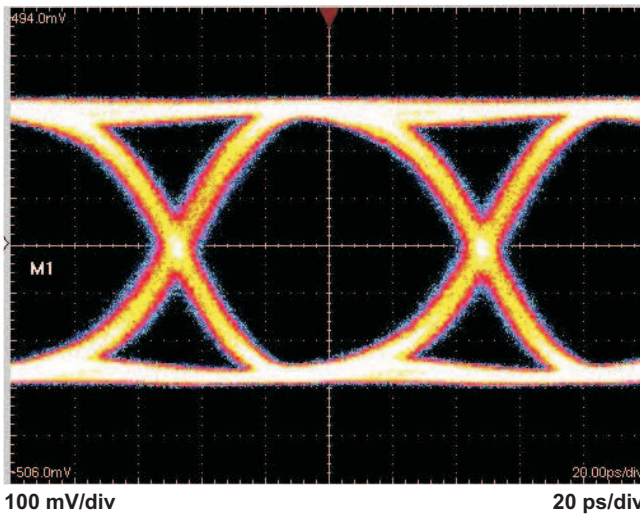

Figure 17.

**OUTPUT EYE-DIAGRAM AT 10.3 GBPS  
AND MAXIMUM INPUT VOLTAGE (2000 mV<sub>PP</sub>)**

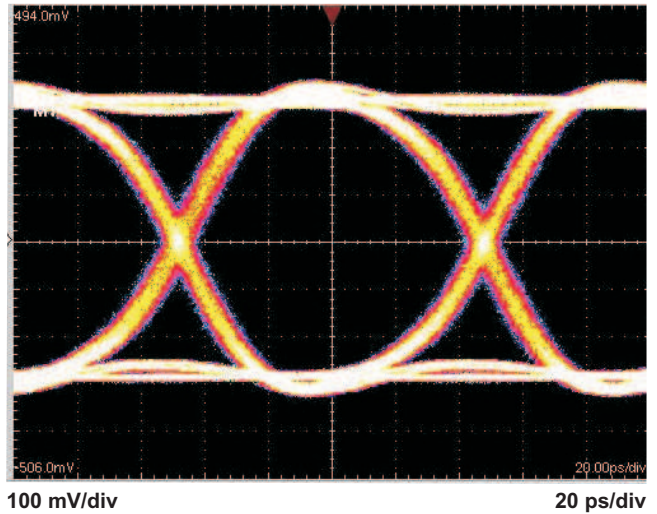

Figure 18.

**TYPICAL OPERATION CHARACTERISTICS (continued)**

Typical operating condition is at  $V_{CC} = 3.3\text{ V}$ ,  $T_A = 25^\circ\text{C}$ , AMP1 = 0, AMP0 = 1 (Register 3) and maximum bandwidth unless otherwise noted.

**OUTPUT EYE-DIAGRAM AT 8.5 GBPS  
AND MINIMUM INPUT VOLTAGE (10 mV<sub>PP</sub>)**

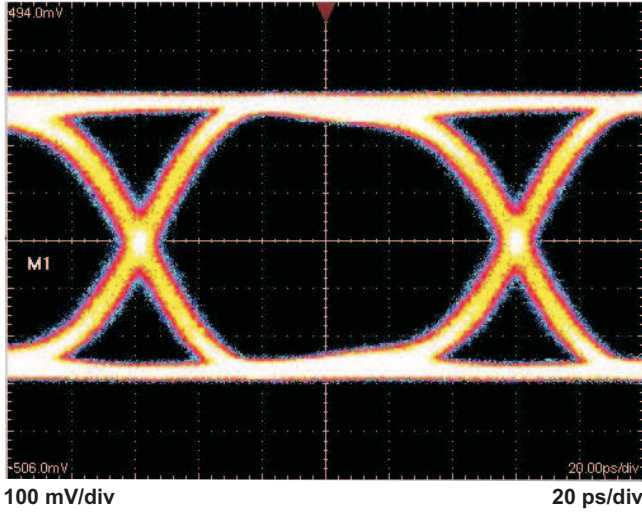

Figure 19.

**OUTPUT EYE-DIAGRAM AT 8.5 GBPS  
AND MAXIMUM INPUT VOLTAGE (2000 mV<sub>PP</sub>)**

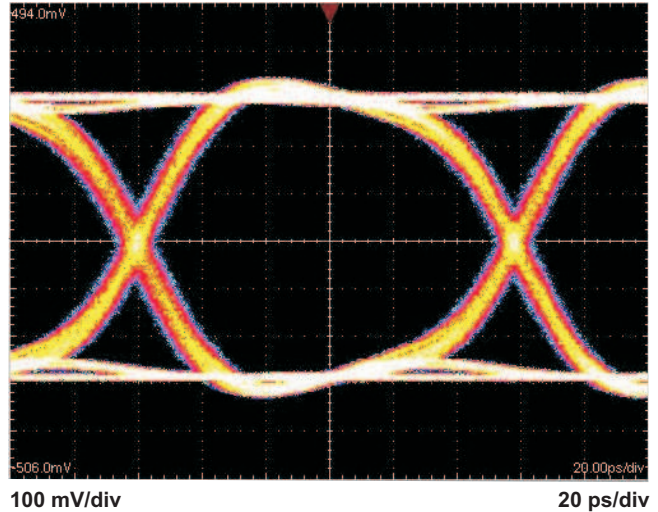

Figure 20.

### APPLICATION INFORMATION

Figure 21 shows a typical application circuit using the ONET8501P.

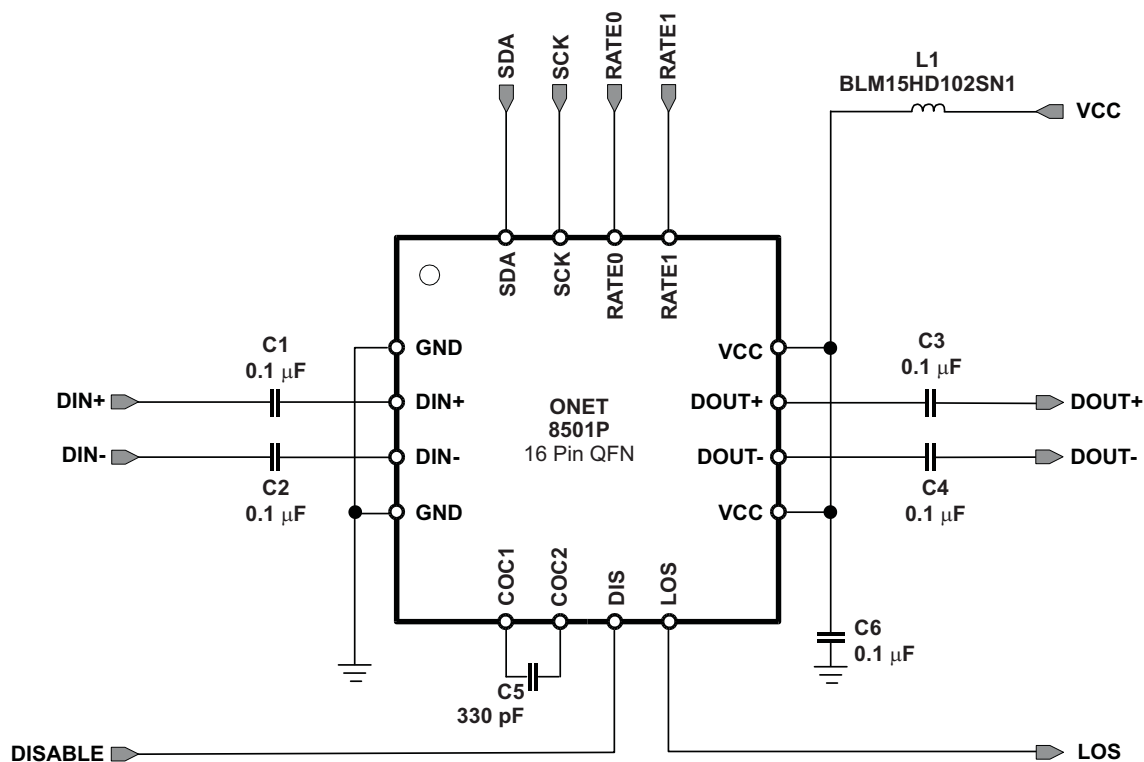

Figure 21. AC Coupled Differential Drive

**PACKAGING INFORMATION**

Orderable Device	Status (1)	Package Type	Package Drawing	Pins	Package Qty	Eco Plan (2)	Lead/Ball Finish (6)	MSL Peak Temp (3)	Op Temp (°C)	Device Marking (4/5)	Samples
ONET8501PRGTR	ACTIVE	VQFN	RGT	16	3000	Green (RoHS & no Sb/Br)	NIPDAU	Level-2-260C-1 YEAR	-40 to 100	850P	<a href="#">Samples</a>
ONET8501PRGTT	ACTIVE	VQFN	RGT	16	250	Green (RoHS & no Sb/Br)	NIPDAU	Level-2-260C-1 YEAR	-40 to 100	850P	<a href="#">Samples</a>

(1) The marketing status values are defined as follows:

**ACTIVE:** Product device recommended for new designs.

**LIFEBUY:** TI has announced that the device will be discontinued, and a lifetime-buy period is in effect.

**NRND:** Not recommended for new designs. Device is in production to support existing customers, but TI does not recommend using this part in a new design.

**PREVIEW:** Device has been announced but is not in production. Samples may or may not be available.

**OBSOLETE:** TI has discontinued the production of the device.

(2) **RoHS:** TI defines "RoHS" to mean semiconductor products that are compliant with the current EU RoHS requirements for all 10 RoHS substances, including the requirement that RoHS substance do not exceed 0.1% by weight in homogeneous materials. Where designed to be soldered at high temperatures, "RoHS" products are suitable for use in specified lead-free processes. TI may reference these types of products as "Pb-Free".

**RoHS Exempt:** TI defines "RoHS Exempt" to mean products that contain lead but are compliant with EU RoHS pursuant to a specific EU RoHS exemption.

**Green:** TI defines "Green" to mean the content of Chlorine (Cl) and Bromine (Br) based flame retardants meet JS709B low halogen requirements of <=1000ppm threshold. Antimony trioxide based flame retardants must also meet the <=1000ppm threshold requirement.

(3) MSL, Peak Temp. - The Moisture Sensitivity Level rating according to the JEDEC industry standard classifications, and peak solder temperature.

(4) There may be additional marking, which relates to the logo, the lot trace code information, or the environmental category on the device.

(5) Multiple Device Markings will be inside parentheses. Only one Device Marking contained in parentheses and separated by a "~" will appear on a device. If a line is indented then it is a continuation of the previous line and the two combined represent the entire Device Marking for that device.

(6) Lead/Ball Finish - Orderable Devices may have multiple material finish options. Finish options are separated by a vertical ruled line. Lead/Ball Finish values may wrap to two lines if the finish value exceeds the maximum column width.

**Important Information and Disclaimer:**The information provided on this page represents TI's knowledge and belief as of the date that it is provided. TI bases its knowledge and belief on information provided by third parties, and makes no representation or warranty as to the accuracy of such information. Efforts are underway to better integrate information from third parties. TI has taken and continues to take reasonable steps to provide representative and accurate information but may not have conducted destructive testing or chemical analysis on incoming materials and chemicals. TI and TI suppliers consider certain information to be proprietary, and thus CAS numbers and other limited information may not be available for release.

In no event shall TI's liability arising out of such information exceed the total purchase price of the TI part(s) at issue in this document sold by TI to Customer on an annual basis.



**TAPE AND REEL INFORMATION**

**QUADRANT ASSIGNMENTS FOR PIN 1 ORIENTATION IN TAPE**

\*All dimensions are nominal

Device	Package Type	Package Drawing	Pins	SPQ	Reel Diameter (mm)	Reel Width W1 (mm)	A0 (mm)	B0 (mm)	K0 (mm)	P1 (mm)	W (mm)	Pin1 Quadrant
ONET8501PRGTR	VQFN	RGT	16	3000	330.0	12.4	3.3	3.3	1.1	8.0	12.0	Q2
ONET8501PRGTT	VQFN	RGT	16	250	180.0	12.4	3.3	3.3	1.1	8.0	12.0	Q2

**TAPE AND REEL BOX DIMENSIONS**

\*All dimensions are nominal

Device	Package Type	Package Drawing	Pins	SPQ	Length (mm)	Width (mm)	Height (mm)
ONET8501PRGTR	VQFN	RGT	16	3000	367.0	367.0	35.0
ONET8501PRGTT	VQFN	RGT	16	250	210.0	185.0	35.0

**RGT 16**

**GENERIC PACKAGE VIEW**

**VQFN - 1 mm max height**

PLASTIC QUAD FLATPACK - NO LEAD

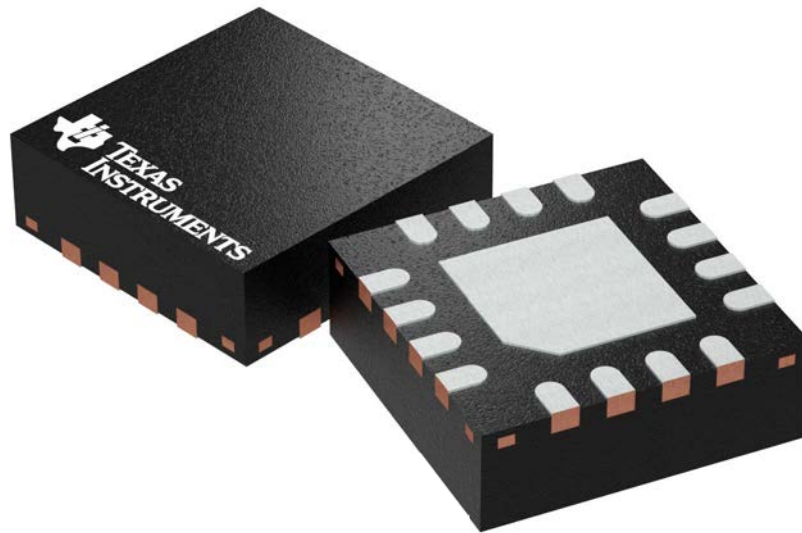

Images above are just a representation of the package family, actual package may vary.  
Refer to the product data sheet for package details.

4203495/1



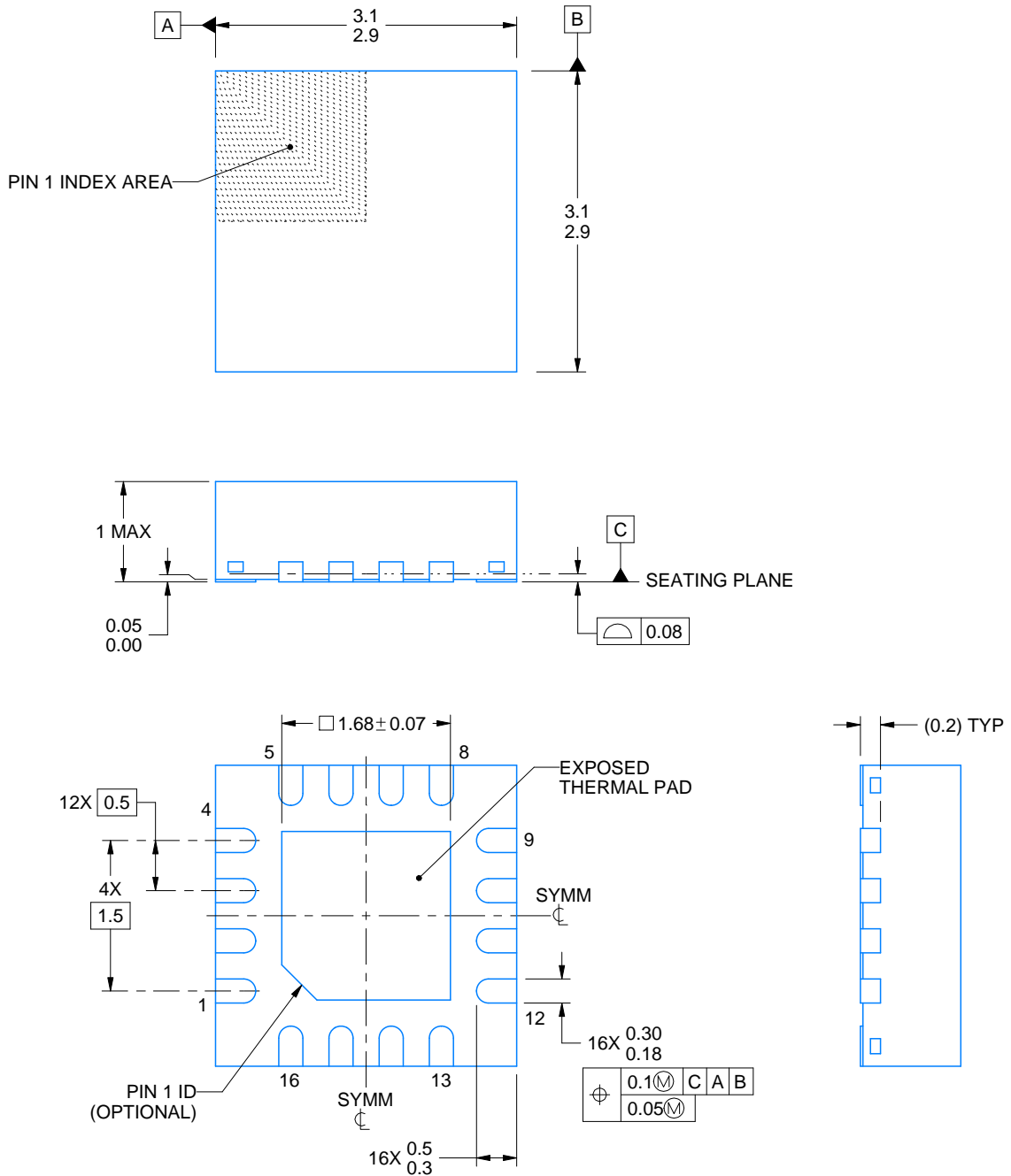
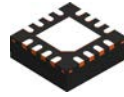

4222419/B 11/2016

NOTES:

1. All linear dimensions are in millimeters. Any dimensions in parenthesis are for reference only. Dimensioning and tolerancing per ASME Y14.5M.
2. This drawing is subject to change without notice.
3. The package thermal pad must be soldered to the printed circuit board for thermal and mechanical performance.

# EXAMPLE BOARD LAYOUT

RGT0016C

VQFN - 1 mm max height

PLASTIC QUAD FLATPACK - NO LEAD

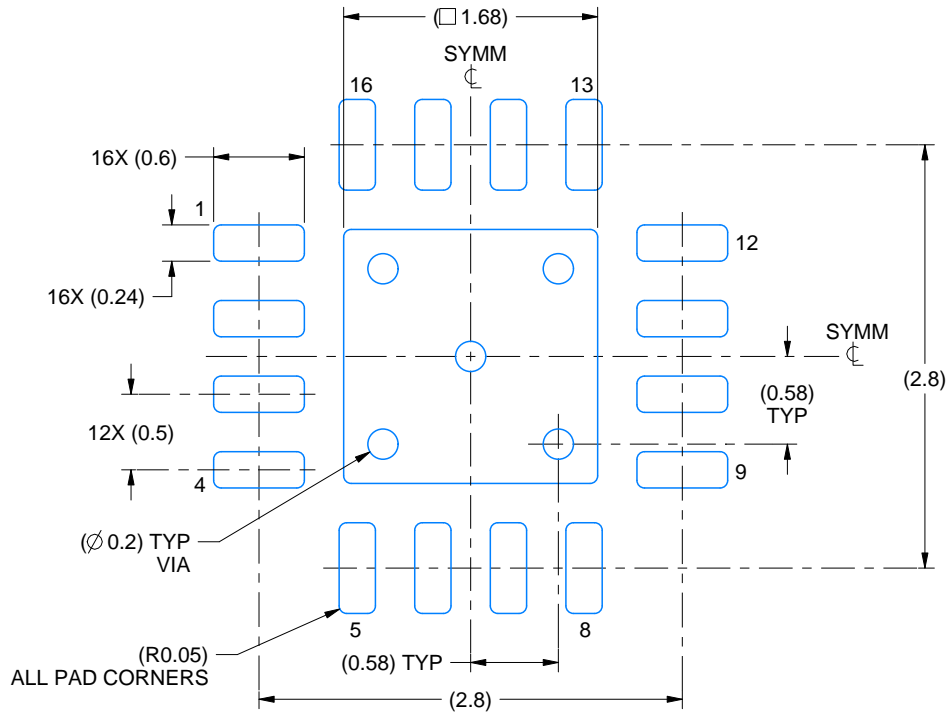

LAND PATTERN EXAMPLE  
SCALE:20X

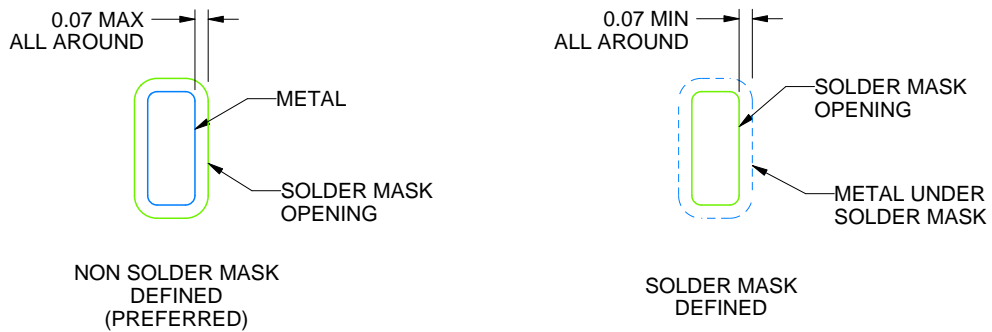

SOLDER MASK DETAILS

4222419/B 11/2016

NOTES: (continued)

4. This package is designed to be soldered to a thermal pad on the board. For more information, see Texas Instruments literature number SLUA271 ([www.ti.com/lit/sluea271](http://www.ti.com/lit/sluea271)).
5. Vias are optional depending on application, refer to device data sheet. If any vias are implemented, refer to their locations shown on this view. It is recommended that vias under paste be filled, plugged or tented.

# EXAMPLE STENCIL DESIGN

RGT0016C

VQFN - 1 mm max height

PLASTIC QUAD FLATPACK - NO LEAD

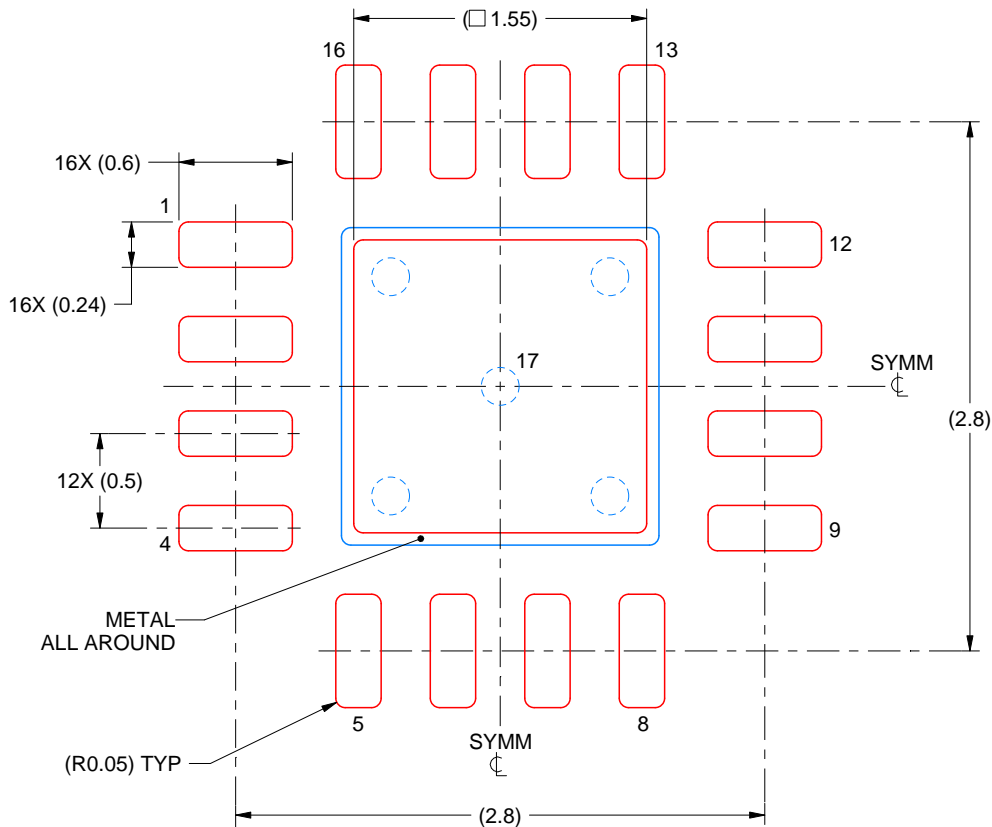

**SOLDER PASTE EXAMPLE**  
BASED ON 0.125 mm THICK STENCIL

EXPOSED PAD 17:  
85% PRINTED SOLDER COVERAGE BY AREA UNDER PACKAGE  
SCALE:25X

4222419/B 11/2016

NOTES: (continued)

6. Laser cutting apertures with trapezoidal walls and rounded corners may offer better paste release. IPC-7525 may have alternate design recommendations.

## IMPORTANT NOTICE AND DISCLAIMER

TI PROVIDES TECHNICAL AND RELIABILITY DATA (INCLUDING DATASHEETS), DESIGN RESOURCES (INCLUDING REFERENCE DESIGNS), APPLICATION OR OTHER DESIGN ADVICE, WEB TOOLS, SAFETY INFORMATION, AND OTHER RESOURCES "AS IS" AND WITH ALL FAULTS, AND DISCLAIMS ALL WARRANTIES, EXPRESS AND IMPLIED, INCLUDING WITHOUT LIMITATION ANY IMPLIED WARRANTIES OF MERCHANTABILITY, FITNESS FOR A PARTICULAR PURPOSE OR NON-INFRINGEMENT OF THIRD PARTY INTELLECTUAL PROPERTY RIGHTS.

These resources are intended for skilled developers designing with TI products. You are solely responsible for (1) selecting the appropriate TI products for your application, (2) designing, validating and testing your application, and (3) ensuring your application meets applicable standards, and any other safety, security, or other requirements. These resources are subject to change without notice. TI grants you permission to use these resources only for development of an application that uses the TI products described in the resource. Other reproduction and display of these resources is prohibited. No license is granted to any other TI intellectual property right or to any third party intellectual property right. TI disclaims responsibility for, and you will fully indemnify TI and its representatives against, any claims, damages, costs, losses, and liabilities arising out of your use of these resources.

TI's products are provided subject to TI's Terms of Sale ([www.ti.com/legal/termsofsale.html](http://www.ti.com/legal/termsofsale.html)) or other applicable terms available either on [ti.com](http://ti.com) or provided in conjunction with such TI products. TI's provision of these resources does not expand or otherwise alter TI's applicable warranties or warranty disclaimers for TI products.

Mailing Address: Texas Instruments, Post Office Box 655303, Dallas, Texas 75265  
Copyright © 2020, Texas Instruments Incorporated