

FIG. 1

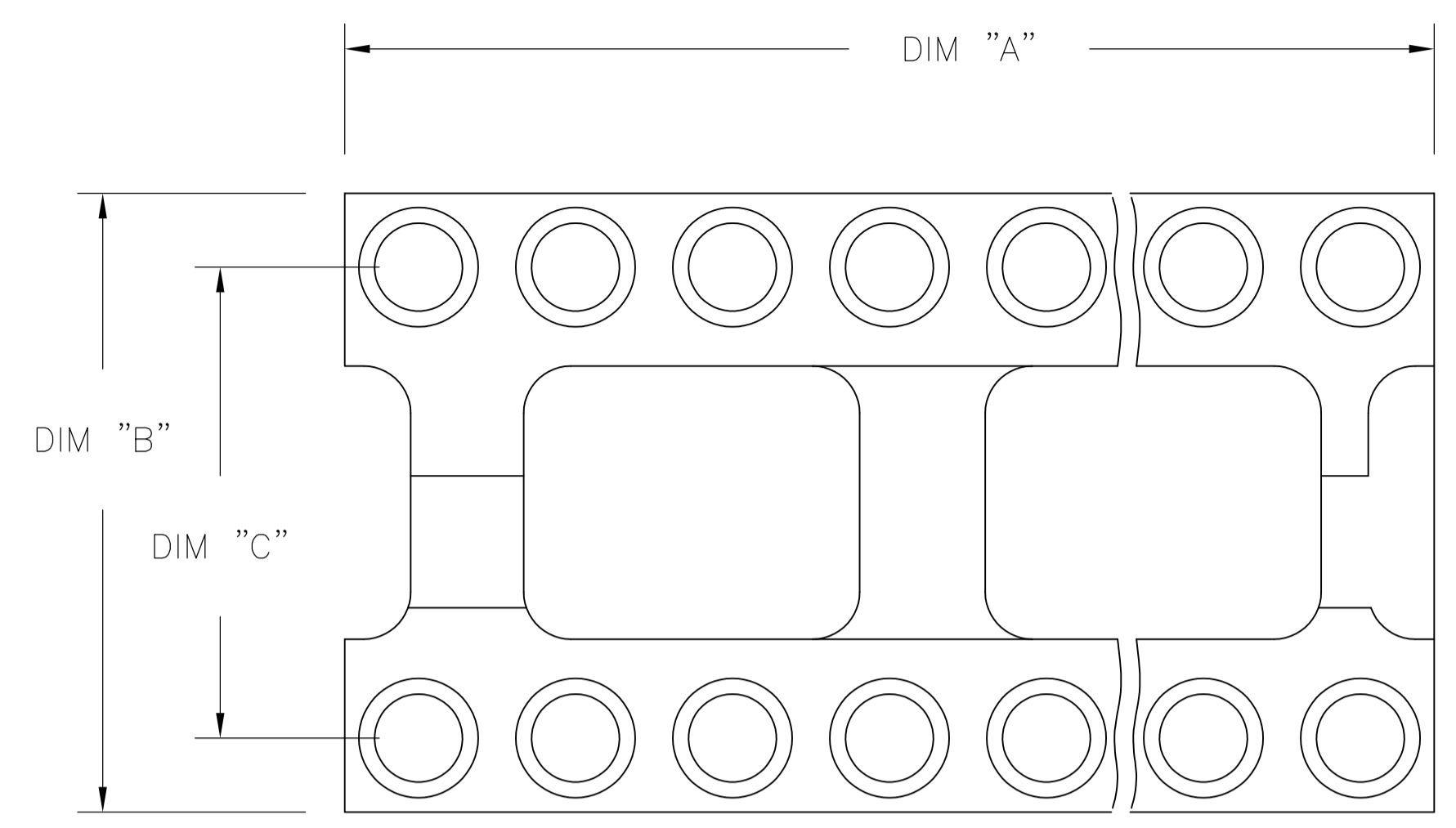

FIG. 2

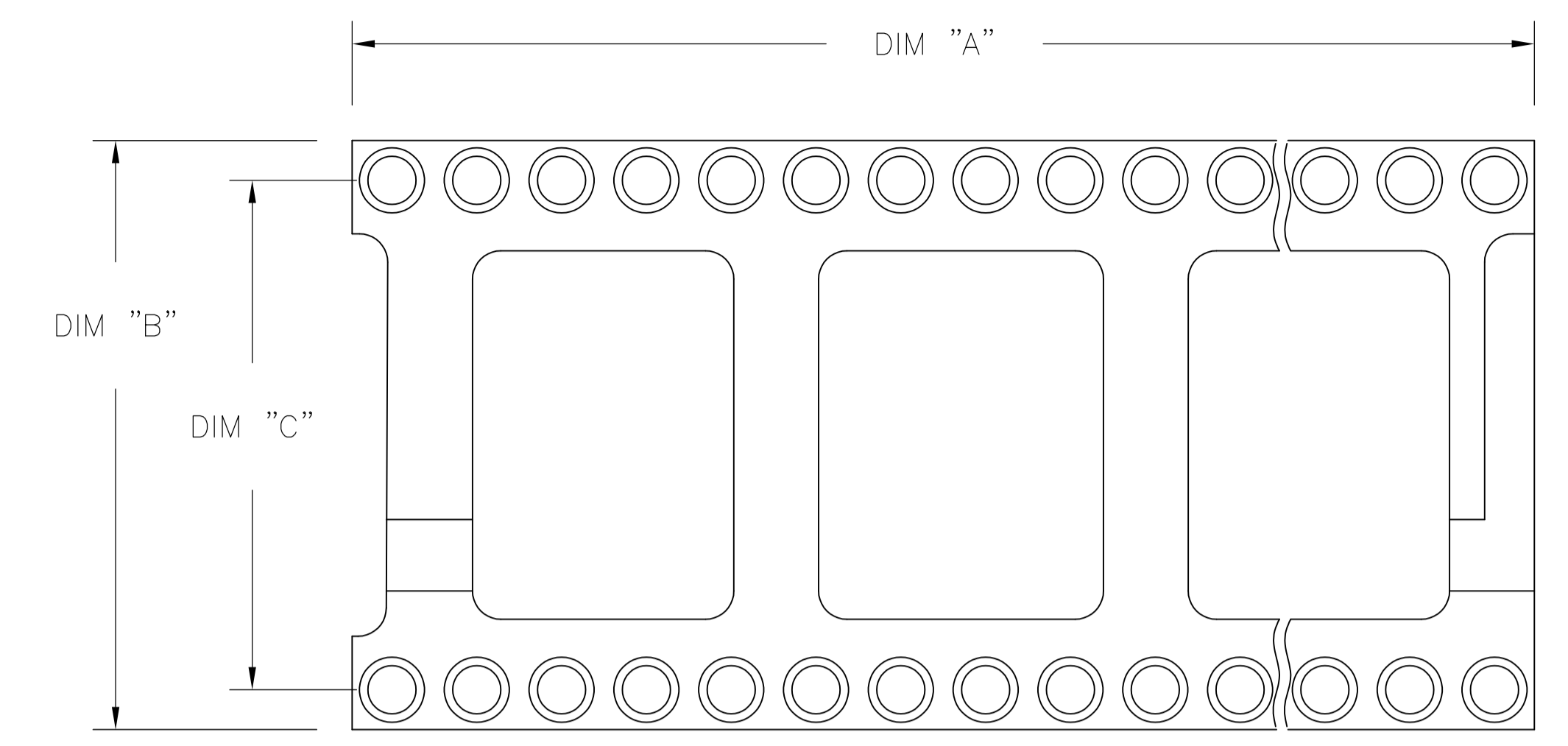
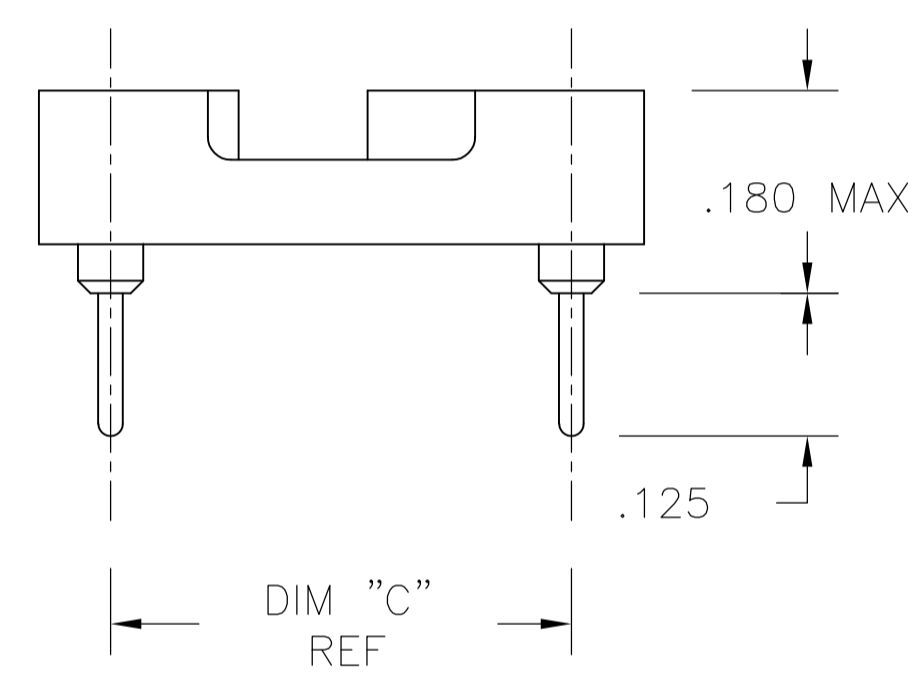
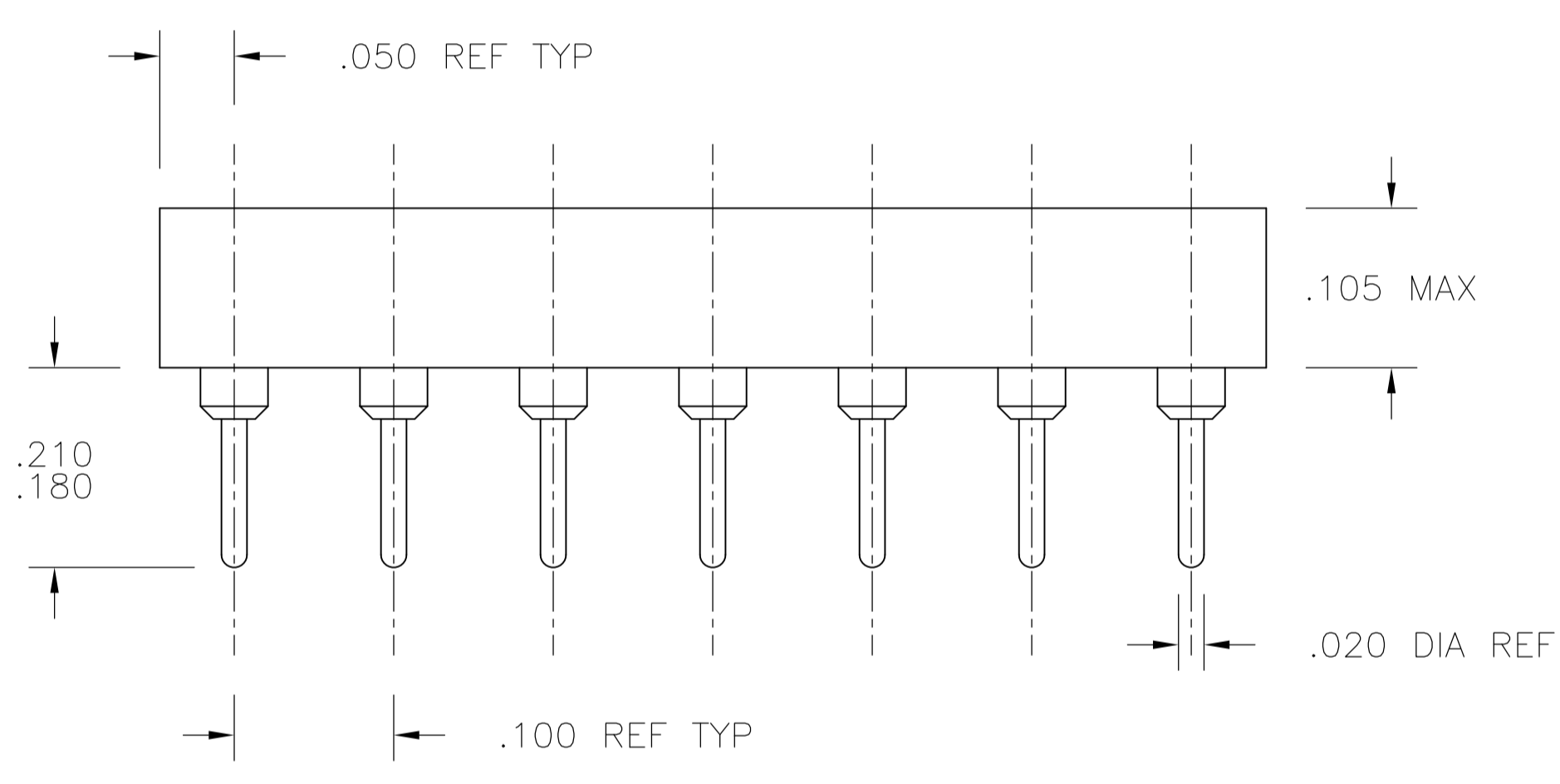
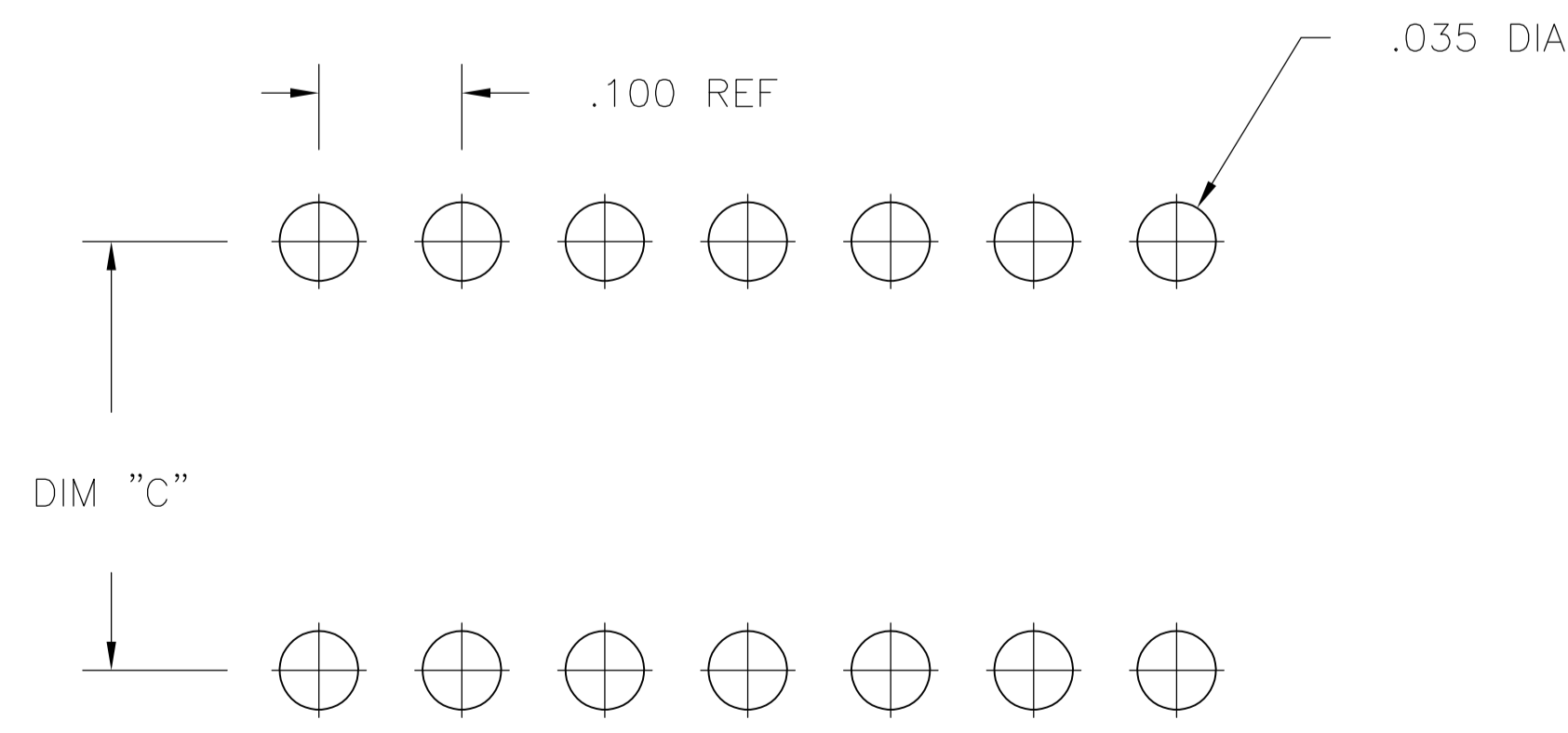

FIG. 3



1. INSULATOR MATERIAL - THERMOPLASTIC POLYESTER, PCT, BLACK, UL94 V-0
2. MACHINED CONTACT - BECU, PLATED WITH 80-200μ" TIN (LEAD FREE) OVER 75-100μ" COPPER.
3. SLEEVE - COPPER, PLATED WITH 180-340μ" THK TIN (LEAD FREE) OVER 75-125 MIN NICKEL.
4. MACHINED CONTACT - BECU, PLATED WITH 25μ" MIN. GOLD OVER 30-100μ" NICKEL.
5. ELECTRICAL:
 CONTACT RESISTANCE: 10 MILLIOHMS MAX
 CONTACT RATING: 3 AMPS
 CAPACITANCE: 1.0 pF PER MIL-STD-202, METHOD 305
 INSULATION RESISTANCE: 5000 OHMS MIN @ 500 VDC PER MIL-STD-1344, METHOD 3003.1
 DIELECTRIC WITHSTANDING VOLTAGE: 1000 VOLTS (RMS) PER MIL-STD-1344, METHOD 3001.1
6. MECHANICAL:
 INSERTION FORCE: 134 GRAMS AVG
 WITHDRAWAL FORCE: 63 GRAMS AVG
 "ACCEPTS IC PIN - .009"X.015" THROUGH .011"X.020", OR .016" TO .021" DIAMETER, .150/.105 LONG"
7. ENVIRONMENTAL:
 OPERATING TEMPERATURE: -55°C TO -105°C
8. OBSOLETE PARTS: OBSOLETE CIS STREAMLINING PER D.RENAUD/D.SINISI



P.C.B. HOLE LAYOUT
 TOLERANCE ±.003

THIS DRAWING IS A CONTROLLED DOCUMENT.		DIN T.KRAYBILL 07NOV03	TE Connectivity	
DIMENSIONS: INCHES		CHK K.WRIGHT	NAME: OPEN FRAME DIP, PREMIUM (MACHINE CONTACT), LEAD FREE (REF AUGAT 800 SERIES)	
TOLERANCES UNLESS OTHERWISE SPECIFIED:		APVD K.WRIGHT	PRODUCT SPEC	
0. PLC ± -		APPLICATION SPEC		
1. PLC ± -		SIZE: A1		
2. PLC ± -		CAGE CODE: 00779		
3. PLC ± .005		DRAWING NO: 1571586		
4. PLC ± -		RESTRICTED TO: -		
ANGLES ± -		WEIGHT: -		
MATERIAL: -		CUSTOMER DRAWING		
FINISH: -		SCALE: 4:1 SHEET 1 OF 2 REV B2		

$\triangle\triangle\triangle$	OBSOLETE	GOLD	TIN	.400±.005	.500	1.200	2	24	3-1571586-7
$\triangle\triangle\triangle$		GOLD	TIN	.300±.005	.400	1.200	2	24	3-1571586-6
$\triangle\triangle\triangle$		GOLD	TIN	.900±.005	1.000	3.200	3	64	3-1571586-5
$\triangle\triangle\triangle$		GOLD	TIN	.600±.005	.700	2.400	3	48	3-1571586-4
$\triangle\triangle\triangle$		GOLD	TIN	.600±.005	.700	2.100	3	42	3-1571586-3
$\triangle\triangle\triangle$		GOLD	TIN	.600±.005	.700	2.000	3	40	3-1571586-2
$\triangle\triangle\triangle$		GOLD	TIN	.600±.005	.700	1.800	3	36	3-1571586-1
$\triangle\triangle\triangle$		GOLD	TIN	.600±.005	.700	1.600	3	32	3-1571586-0
$\triangle\triangle\triangle$		GOLD	TIN	.600±.005	.700	1.400	2	28	2-1571586-9
$\triangle\triangle\triangle$		GOLD	TIN	.600±.005	.700	1.200	2	24	2-1571586-8
$\triangle\triangle\triangle$		GOLD	TIN	.400±.005	.500	1.100	2	22	2-1571586-7
$\triangle\triangle\triangle$		GOLD	TIN	.300±.005	.400	1.000	2	20	2-1571586-6
$\triangle\triangle\triangle$		GOLD	TIN	.300±.005	.400	.900	2	18	2-1571586-5
$\triangle\triangle\triangle$		GOLD	TIN	.300±.005	.400	.800	2	16	2-1571586-4
$\triangle\triangle\triangle$		GOLD	TIN	.300±.005	.400	.700	2	14	2-1571586-3
$\triangle\triangle\triangle$		GOLD	TIN	.300±.005	.400	.400	1	8	2-1571586-2
$\triangle\triangle\triangle$		TIN	TIN	.400±.005	.500	1.200	2	24	1-1571586-7
$\triangle\triangle\triangle$		TIN	TIN	.300±.005	.400	1.200	2	24	1-1571586-6
$\triangle\triangle\triangle$	OBSOLETE	TIN	TIN	.900±.005	1.000	3.200	3	64	1-1571586-5
$\triangle\triangle\triangle$	OBSOLETE	TIN	TIN	.600±.005	.700	2.400	3	48	1-1571586-4
$\triangle\triangle\triangle$	OBSOLETE	TIN	TIN	.600±.005	.700	2.100	3	42	1-1571586-3
$\triangle\triangle\triangle$	OBSOLETE	TIN	TIN	.600±.005	.700	2.000	3	40	1-1571586-2
$\triangle\triangle\triangle$	OBSOLETE	TIN	TIN	.600±.005	.700	1.800	3	36	1-1571586-1
$\triangle\triangle\triangle$		TIN	TIN	.600±.005	.700	1.600	3	32	1-1571586-0
$\triangle\triangle\triangle$	OBSOLETE	TIN	TIN	.600±.005	.700	1.400	2	28	1571586-9
$\triangle\triangle\triangle$	OBSOLETE	TIN	TIN	.600±.005	.700	1.200	2	24	1571586-8
$\triangle\triangle\triangle$	OBSOLETE	TIN	TIN	.400±.005	.500	1.100	2	22	1571586-7
$\triangle\triangle\triangle$		TIN	TIN	.300±.005	.400	1.000	2	20	1571586-6
$\triangle\triangle\triangle$	OBSOLETE	TIN	TIN	.300±.005	.400	.900	2	18	1571586-5
$\triangle\triangle\triangle$	OBSOLETE	TIN	TIN	.300±.005	.400	.800	2	16	1571586-4
$\triangle\triangle\triangle$	OBSOLETE	TIN	TIN	.300±.005	.400	.700	2	14	1571586-3
$\triangle\triangle\triangle$		TIN	TIN	.300±.005	.400	.400	1	8	1571586-2

FINISH	"C" MAX	"B" MAX	"A" MAX	FIG	NO. OF POSN	PART NO.
CONTACT/SLEEVE						

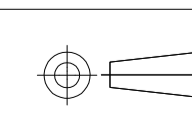
THIS DRAWING IS A CONTROLLED DOCUMENT.		DIN T. KRAYBILL 07NOV03	 TE Connectivity	
DIMENSIONS: INCHES	TOLERANCES UNLESS OTHERWISE SPECIFIED:	CHK K. WRIGHT	NAME: OPEN FRAME DIP, PREMIUM (MACHINE CONTACT), LEAD FREE (REF AUGAT 800 SERIES)	
0. PLC ± - 1. PLC ± - 2. PLC ± - 3. PLC ± .005 4. PLC ± - ANGLES ± -		APVD K. WRIGHT	APPLICATION SPEC	SIZE: A1
MATERIAL	FINISH	WEIGHT	CUSTOMER DRAWING	DRAWING NO: 00779C=1571586 SCALE: 1:1 SHEET 2 OF 2 REV B2

Mouser Electronics

Authorized Distributor

Click to View Pricing, Inventory, Delivery & Lifecycle Information:

[TE Connectivity:](#)

[1571586-2](#)