

Microelectronic Power IC

HEXFET® Power MOSFET Photovoltaic Relay
 Single-Pole, Normally-Open, 0-20V, 2.5A AC / 4.5A DC

General Description

The PVN013 Series Photovoltaic Relay at 100 milliohms features the lowest possible on-state resistance in a miniature package — lower than a comparable reed relay.

The PVN013 is a single-pole, normally open solid-state relay. It utilizes a GenerationV HEXFET output switch, driven by an integrated circuit photovoltaic generator of novel construction. The output switch is controlled by radiation from a GaAIAs light emitting diode (LED) which is optically isolated from the photovoltaic generator.

These units exceed the performance capabilities of electromechanical relays in life, sensitivity, stable on-resistance, low off-state leakage, miniaturization, magnetic insensitivity and ruggedness. They are ideally suited for switching high currents or low level signals without distortion or injection of electrical noise.

Series PVN013 Relays are packaged in a 6-lead molded DIP package with either thru-hole or surface mount (gull-wing) terminals. They are available in standard plastic shipping tubes or on tape-and-reel. Please refer to part identification information opposite.

Applications

- Portable Electronics
- Industrial Control
- Computers and Peripheral Devices
- Audio Equipment
- Power Supplies and Power Distribution
- Instrumentation

Features

- 100mΩ On-Resistance
- Extremely low off-state leakage
- Bounce-free operation
- 2.5 - 4.5 Amp capacity
- Linear AC/DC operation
- 4,000 V_{RMS} I/O isolation
- Solid-State reliability
- UL recognized
- ESD Tolerance:
 4000V Human Body Model
 500V Machine Model

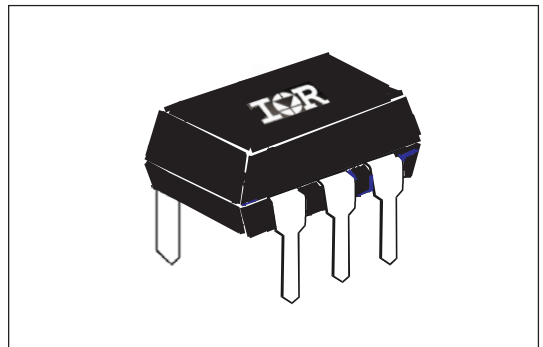

Part Identification

PVN013PbF	thru-hole
PVN013SPbF	surface-mount
PVN013S-TPbF	surface-mount, tape and reel

(HEXFET is the registered trademark for International Rectifier Power MOSFETs)

Electrical Specifications ($-40^{\circ}\text{C} \leq T_A \leq +85^{\circ}\text{C}$ unless otherwise specified)

INPUT CHARACTERISTICS	Limits	Units
Minimum Control Current (see figure 1)	3.0	mA
Maximum Control Current for Off-State Resistance @ $T_A = +25^{\circ}\text{C}$	0.4	mA
Control Current Range (Caution: current limit input LED, see figure 6)	3.0 to 25	mA
Maximum Reverse Voltage	6.0	V

OUTPUT CHARACTERISTICS	Limits	Units
Operating Voltage Range	0 to ± 20	V(DC or AC peak)
Maximum Continuous Load Current @ $T_A = +40^{\circ}\text{C}$, 5mA Control (see figure 1)		
A Connection	2.5	A (DC or AC)
B Connection	3.0	A (DC)
C Connection	4.5	A (DC)
Maximum Pulsed Load Current @ $T_A = +25^{\circ}\text{C}$, (100 ms @ 10% duty cycle)		
A Connection	6.0	A (DC or AC)
Maximum On-State Resistance @ $T_A = +25^{\circ}\text{C}$, for 1A pulsed load, 5mA Control (see figure 4)		
A Connection	100	m Ω
B Connection	65	
C Connection	40	
Maximum Off-State Leakage @ $T_A = +25^{\circ}\text{C}$, $\pm 16V_{DC}$	10	nA
Maximum Turn-On Time @ $T_A = +25^{\circ}\text{C}$ (see figure 7), for 1A, 20 V_{DC} load, 5mA Control	5.0	ms
Maximum Turn-Off Time @ $T_A = +25^{\circ}\text{C}$ (see figure 7), for 1A, 20 V_{DC} load, 5mA Control	0.5	ms
Maximum Output Capacitance @ 20 V_{DC} (see figure 2)	300	pF

GENERAL CHARACTERISTICS	Limits	Units	
Minimum Dielectric Strength, Input-Output	4000	V _{RMS}	
Minimum Insulation Resistance, Input-Output, @ $T_A = +25^{\circ}\text{C}$, 50%RH, 100 V_{DC}	10^{12}	Ω	
Maximum Capacitance, Input-Output	1.0	pF	
Maximum Pin Soldering Temperature (10 seconds maximum)	+260	$^{\circ}\text{C}$	
Ambient Temperature Range:	Operating		-40 to +85
	Storage		-40 to +100

International Rectifier does not recommend the use of this product in aerospace, avionics, military or life support applications. Users of this International Rectifier product in such applications assume all risks of such use and indemnify International Rectifier against all damages resulting from such use.

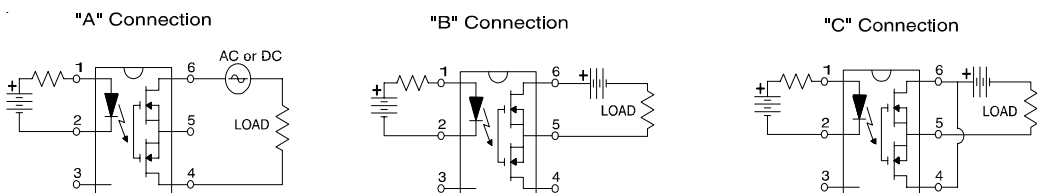
Connection Diagrams

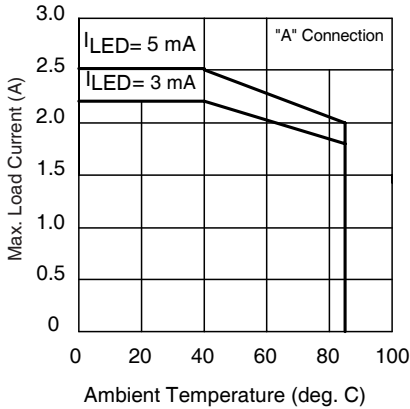

Figure 1. Current Derating Curves*

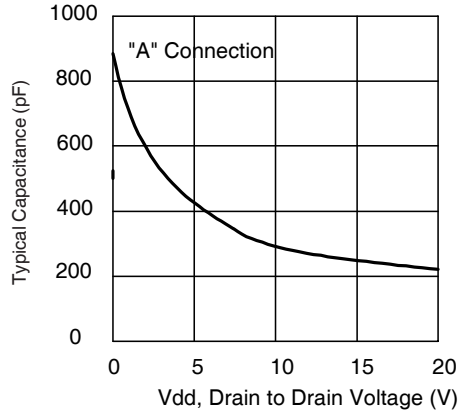

Figure 2. Typical Output Capacitance

* Derating of 'B' and 'C' connection at +85°C will be 70% of that specified at +40°C and is linear from +40°C to +85°C.

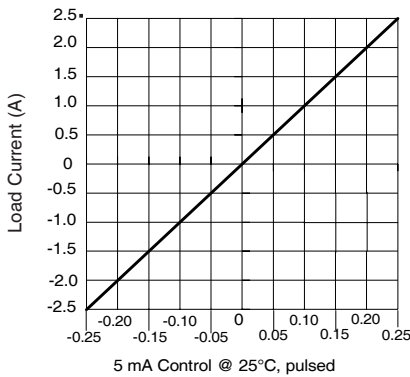

Figure 3. Linearity Characteristics

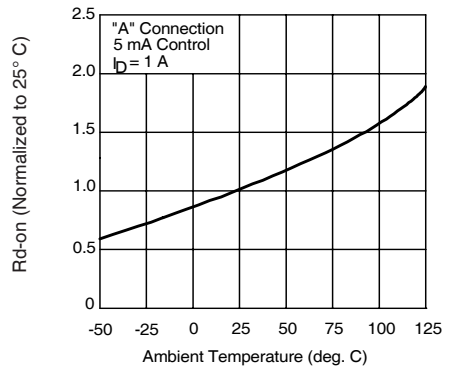

Figure 4. Typical Normalized On-Resistance

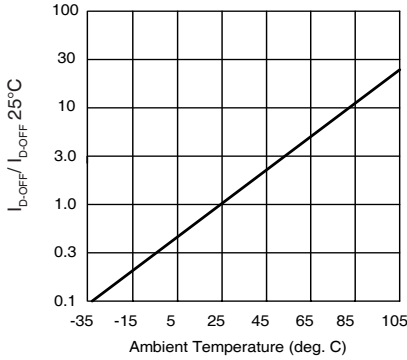

Figure 5. Typical Normalized Off-State Leakage

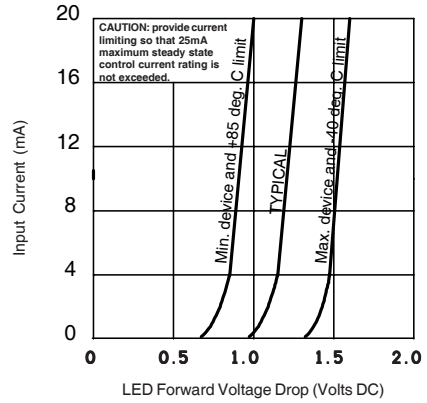

Figure 6. Input Characteristics (Current Controlled)

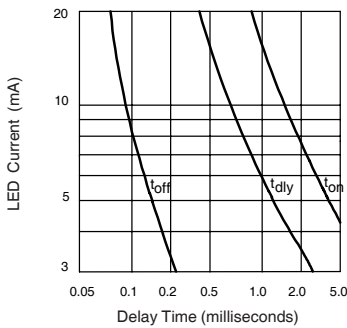

Figure 7. Typical Delay Times

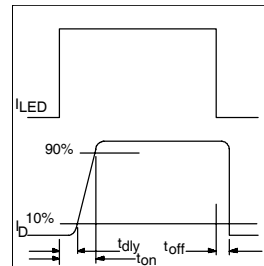
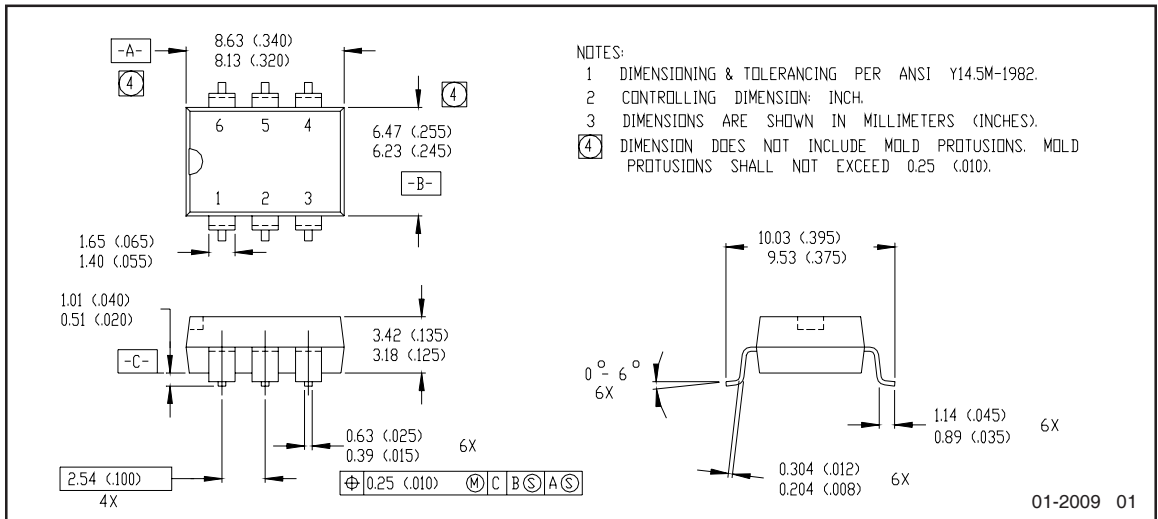
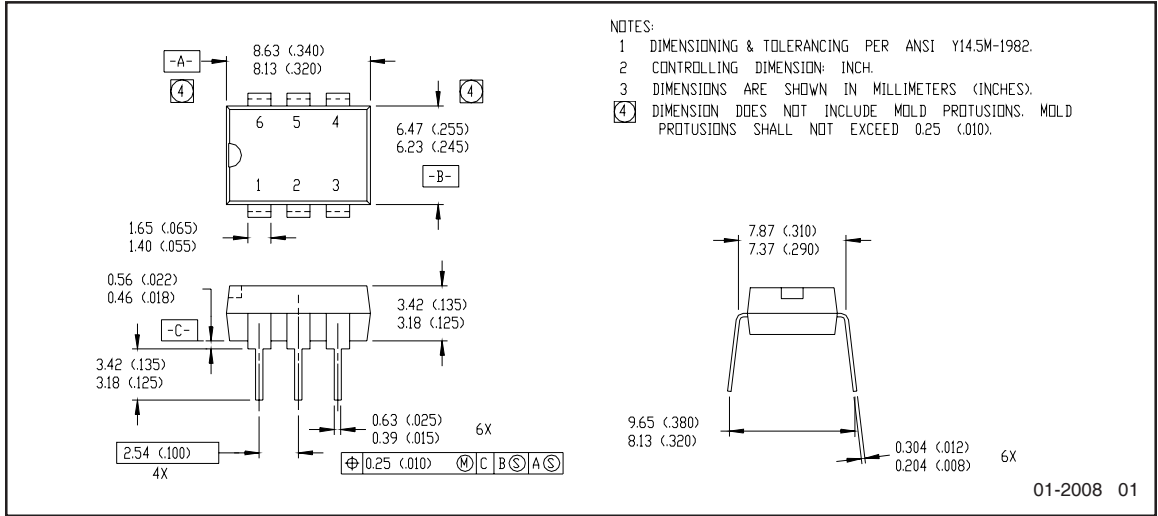

Figure 8. Delay Time Definitions

Case Outlines



Note: For the most current drawing please refer to IR website at: <http://www.irf.com/package/>

Qualification information[†]

Qualification level	Industrial (per JEDEC JESD471 ^{††} guidelines)	
Moisture Sensitivity Level	PVN013PbF	N/A
	PVN013SPbF	MSL4
	PVN013S-TPbF	(per JEDEC J-STD-020E & JEDEC J-STD-033C ^{††})
RoHS compliant	Yes	

† Qualification standards can be found at International Rectifier's web site: <http://www.irf.com/product-info/reliability>

†† Applicable version of JEDEC standard at the time of product release

Revision History

Date	Comments
5/11/2015	<ul style="list-style-type: none"> • Added Qualification Information Table on page 6 • Updated data sheet with new IR corporate template

Mouser Electronics

Authorized Distributor

Click to View Pricing, Inventory, Delivery & Lifecycle Information:

[Infineon:](#)

[PVN013PBF](#) [PVN013S-TPBF](#) [PVN013SPBF](#)