

EVALUATION KIT  
AVAILABLE

## 2.7V to 18V, 7A, Hot-Swap Solution

### General Description

The MAX5976A/MAX5976B are integrated solutions for hot-swap applications requiring the safe insertion and removal of circuit line cards from a live backplane. The devices integrate a hot-swap controller, 24mΩ power MOSFET, and electronic circuit-breaker protection in a single package. The ICs are designed for protection of 2.7V to 18V supply voltages.

The devices provide inrush current control and short-circuit detection during startup. During normal operation, the devices provide circuit-breaker protection against overload and short-circuit conditions. The circuit-breaker function disconnects the power to the load if the load current exceeds the circuit-breaker limit. The devices are factory-calibrated to deliver accurate overcurrent protection with  $\pm 10\%$  accuracy. During a fault condition, the MAX5976A enters an autoretry mode while the MAX5976B latches off. Both versions feature a resistor-adjustable variable speed circuit-breaker threshold and overtemperature protection. Additional features include power-good and fault indicator outputs.

The ICs are available in a 16-pin, 5mm x 5mm, TQFN-EP package and fully specified over the  $-40^{\circ}\text{C}$  to  $+85^{\circ}\text{C}$  operating temperature range.

### Applications

RAID Systems  
Storage Bridge Bay  
Disk Drive Power  
Server I/O Cards  
Industrial

### Features

- ◆ 2.7V to 18V Operating Voltage Range
- ◆ 24mΩ Internal Power MOSFET
- ◆ 7A Load Current Capability
- ◆ No Sense Resistor Required
- ◆  $\pm 10\%$  Circuit-Breaker Threshold Accuracy
- ◆ Adjustable Circuit-Breaker Current
- ◆ Variable Speed Circuit-Breaker Response
- ◆ Thermal Protection
- ◆ Power-Good and Fault Outputs
- ◆ Latch-Off or Automatic Retry Options
- ◆ Drive-Present Signal Input
- ◆ Active-Low and Active-High Enables

### Ordering Information

PART	PIN PACKAGE	FAULT MANAGEMENT
MAX5976AETE+	16 TQFN-EP*	Autoretry
MAX5976BETE+	16 TQFN-EP*	Latched Off

**Note:** All devices are specified over the  $-40^{\circ}\text{C}$  to  $+85^{\circ}\text{C}$  operating temperature range.

+ Denotes a lead(Pb)-free/RoHS-compliant package.

\*EP = Exposed pad.

### Typical Application Circuit

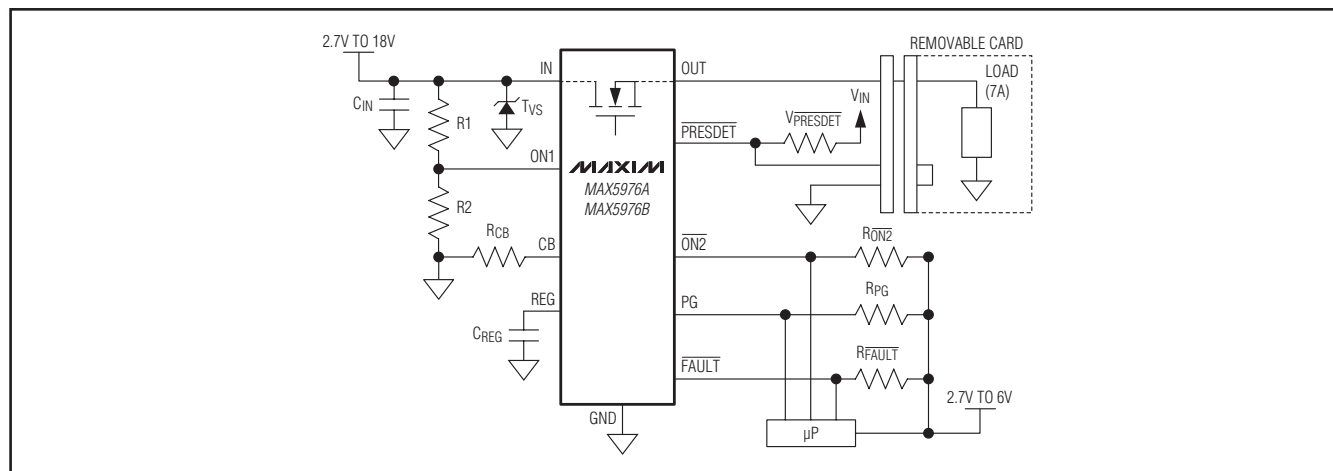

## 2.7V to 18V, 7A, Hot-Swap Solution

### ABSOLUTE MAXIMUM RATINGS

IN to GND ..... -0.3V to +20V  
 CB to GND ..... -0.3V to (VREG + 0.3V)  
 ON1, REG to GND ..... -0.3V to +6V  
 OUT, ON2, PRESDTET  
 to GND ..... -0.3V to the lower of (VIN + 0.3V) and +20V  
 PG, FAULT to GND ..... -0.3V to +26V  
 Continuous Power Dissipation (TA = +70°C)  
 TQFN (derate 33.3mW/°C above +70°C) (Note 1) ..2666.7mW

Operating Ambient Temperature Range ..... -40°C to +85°C  
 Maximum Junction Temperature..... +150°C  
 Storage Temperature Range..... -60°C to +150°C  
 Lead Temperature (soldering, 10s) ..... +300°C  
 Soldering Temperature (reflow) ..... +260°C

**Note 1:** As per JEDEC51 standard (multilayer board).

Stresses beyond those listed under "Absolute Maximum Ratings" may cause permanent damage to the device. These are stress ratings only, and functional operation of the device at these or any other conditions beyond those indicated in the operational sections of the specifications is not implied. Exposure to absolute maximum rating conditions for extended periods may affect device reliability.

### PACKAGE THERMAL CHARACTERISTICS (Note 2)

TQFN

Junction-to-Case Thermal Resistance ( $\theta_{JC}$ ) ..... 30°C/W

Junction-to-Ambient Thermal Resistance ( $\theta_{JA}$ ) ..... 2°C/W

**Note 2:** Package thermal resistances were obtained using the method described in JEDEC specification JESD51-7, using a four-layer board. For detailed information on package thermal considerations, refer to [www.maxim-ic.com/thermal-tutorial](http://www.maxim-ic.com/thermal-tutorial).

### ELECTRICAL CHARACTERISTICS

(VIN = 12V, VON1 = 2V, VON2 = VPRESDET = 0V, RCB = 40k $\Omega$ , TA = TJ = -40°C to +85°C, unless otherwise noted. Typical values are at TA = +25°C.) (Note 3)

PARAMETER	SYMBOL	CONDITIONS	MIN	TYP	MAX	UNITS
Input Supply Voltage Range	VIN		2.7		18	V
Input Supply Current	IIN	VON1 = 3V, no load, 7A current-limit threshold		5	7.5	mA
Default Undervoltage Lockout	VUVLO	VIN rising, VON1 = VIN	2.35	2.5	2.65	V
Default Undervoltage Lockout Hysteresis	VUVLO_HYS			0.1		V
ON1 Turn-On Threshold	VON1_TH	VON1 rising	1.17	1.21	1.25	V
ON1 Turn-On Threshold Hysteresis	VON1_HYS	VON1 falling		0.1		V
ON1 Input Bias Current	ION1	VON1 = 0 to 5V	-1		+1	$\mu$ A
<b>CURRENT LIMIT</b>						
Circuit-Breaker Accuracy (At Startup)	ICB,TH	RCB = 40k $\Omega$	6.3	7	7.7	A
		RCB = 28.57k $\Omega$	4.5	5	5.5	
		RCB = 20k $\Omega$	3.15	3.5	3.85	
		RCB = 10k $\Omega$	1.575	1.75	1.925	
Slow-Comparator Response Time (Note 4)	tSCD	0.6% overcurrent		2.7		ms
		30% overcurrent		200		$\mu$ s
<b>MOSFET</b>						
Total On-Resistance	RON		15	24	41	m $\Omega$
<b>LOGIC INPUTS (ON2, PRESDTET)</b>						
Low Voltage Input	VIL	2.7V < VIN < 18V			0.4	V
High Voltage Input	VIH	2.7V < VIN < 18V	1.4			V
Input Current	IIN	VON2, VPRESDET = 0 to 6V	-1		+1	$\mu$ A

## 2.7V to 18V, 7A, Hot-Swap Solution

### ELECTRICAL CHARACTERISTICS (continued)

( $V_{IN} = 12V$ ,  $V_{ON1} = 2V$ ,  $V_{ON2} = V_{PRESDT} = 0V$ ,  $R_{CB} = 40k\Omega$ ,  $T_A = T_J = -40^\circ C$  to  $+85^\circ C$ , unless otherwise noted. Typical values are at  $T_A = +25^\circ C$ .) (Note 3)

PARAMETER	SYMBOL	CONDITIONS	MIN	TYP	MAX	UNITS
<b>OPEN-DRAIN OUTPUTS</b>						
$\overline{FAULT}$ , PG Output Low Voltage	$V_{OL}$	Low-impedance state, $I_{FAULT} = I_{PG} = 5mA$			0.4	V
$\overline{FAULT}$ , PG Output High Leakage Current	$I_{OH}$	High-impedance state, $V_{FAULT} = V_{PG} = 16V$			1	$\mu A$
OUT Bias Current	$I_{OUT}$	$V_{ON1} = GND$			10	$\mu A$
<b>TIMING</b>						
Automatic Restart Delay After Current-Limit Timeout	$t_{OFF}$			250		ms
PG Assertion Delay	$t_{PG}$	From $V_{OUT} > V_{PG}$		16		ms
PG Threshold	$V_{PG}$	$V_{OUT} = 12V$		$0.9 \times V_{IN}$		V
<b>THERMAL PROTECTION</b>						
Thermal-Shutdown Threshold				150		$^\circ C$
Thermal-Shutdown Threshold Hysteresis				20		$^\circ C$

**Note 3:** All devices are 100% production tested at  $T_A = +25^\circ C$ . Limits over temperature are guaranteed by design.

**Note 4:** The current-limit slow-comparator response time is weighed against the amount of overcurrent so that the higher the overcurrent condition, the faster the response time.

### Typical Operating Characteristics

( $V_{IN} = 12V$ ,  $V_{ON1} = 2V$ ,  $R_{CB} = 40k\Omega$ ,  $V_{ON2} = V_{PRESDT} = 0V$ ,  $T_A = +25^\circ C$ , unless otherwise noted.)

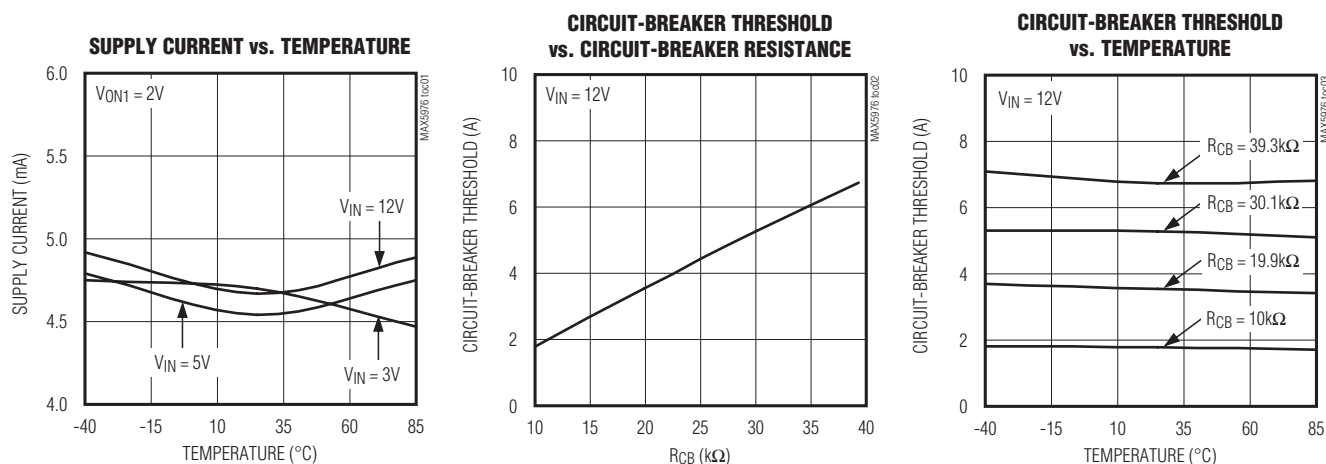

# 2.7V to 18V, 7A, Hot-Swap Solution

## Typical Operating Characteristics (continued)

( $V_{IN} = 12V$ ,  $V_{ON1} = 2V$ ,  $R_{CB} = 40k\Omega$ ,  $V_{ON2} = V_{PRESDET} = 0V$ ,  $T_A = +25^\circ C$ , unless otherwise noted.)

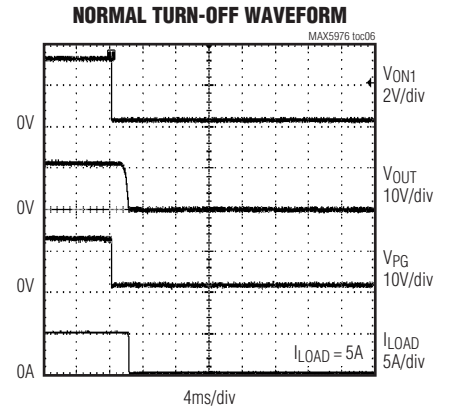
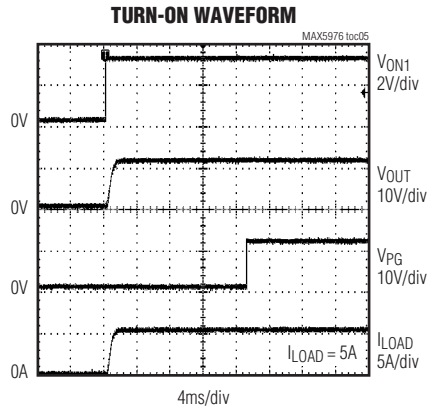
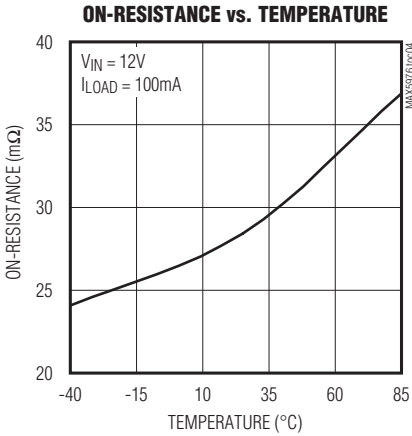

**FAULT SHUTDOWN WAVEFORM—OVERLOAD (SLOW TRIP)**

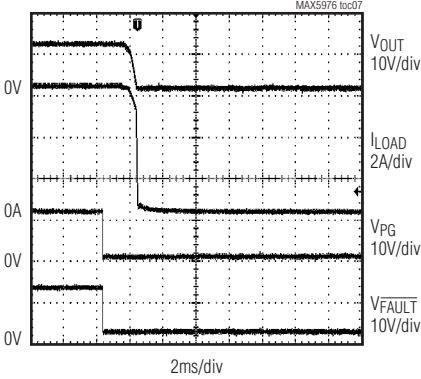

**FAULT SHUTDOWN WAVEFORM—SHORT CIRCUIT**

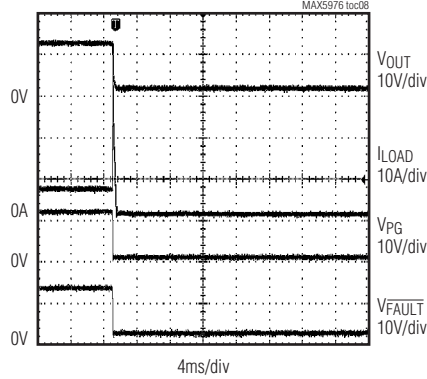

**ON1 RISING/FALLING THRESHOLD VOLTAGE vs. TEMPERATURE**

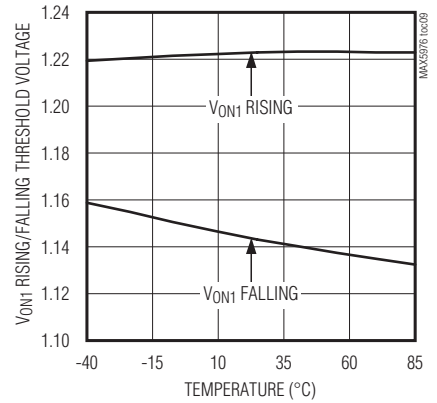

**PG ASSERTION DELAY**

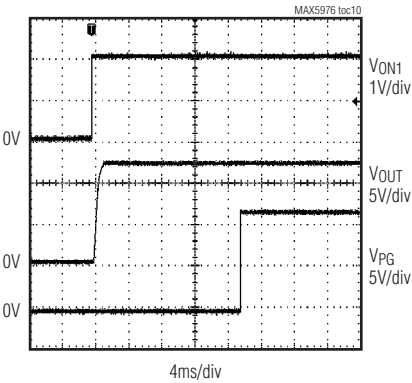

**AUTORETRY FUNCTIONALITY**

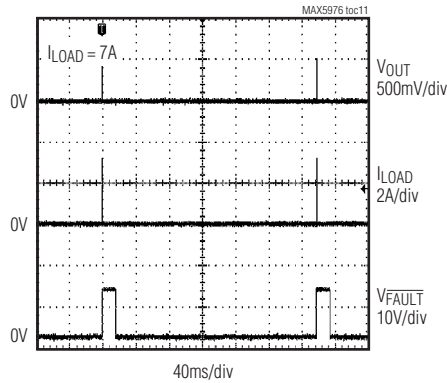

**CIRCUIT-BREAKER THRESHOLD TIME vs. OVERCURRENT**

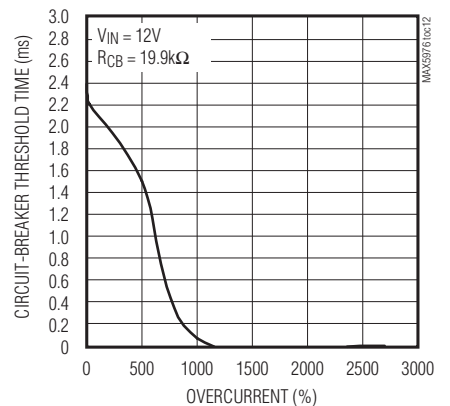

# 2.7V to 18V, 7A, Hot-Swap Solution

**MAX5976A/MAX5976B**

## Pin Configuration

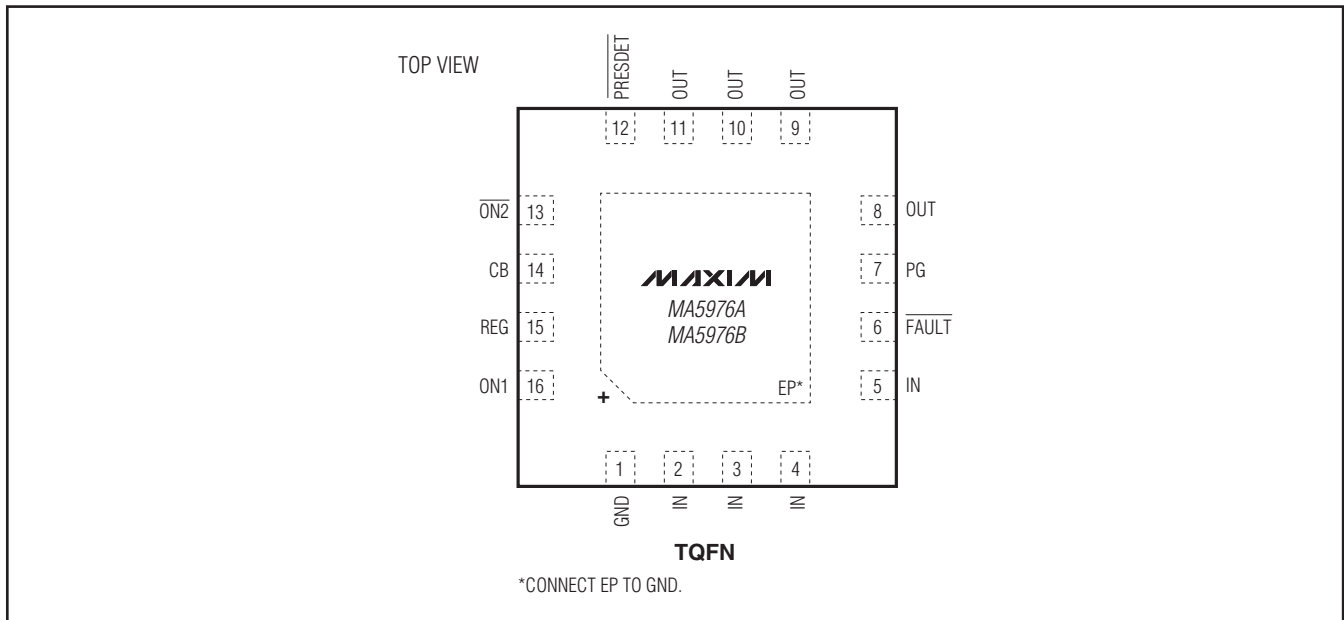

## Pin Description

PIN	NAME	FUNCTION
1	GND	Ground
2–5	IN	Supply Voltage Input. IN is connected to the drain of the internal 24mΩ MOSFET. Bypass IN with 1μF capacitor to ground. Add a transient voltage suppressor diode from IN to GND for output short-circuit protection.
6	$\overline{\text{FAULT}}$	Fault Status Output. $\overline{\text{FAULT}}$ is an open-drain, active-low output. $\overline{\text{FAULT}}$ asserts low when an over-current or overtemperature condition triggers a shutdown.
7	PG	Power-Good Output. PG is an open-drain, active-high output. PG pulls low until the internal power MOSFET is fully enhanced.
8–11	OUT	Load Connection Point. Source of the internal power MOSFET.
12	$\overline{\text{PRESDT}}$	Active-Low Present-Detect Logic Input. Pulling $\overline{\text{PRESDT}}$ to GND enables the output if $\overline{\text{ON2}}$ is low and ON1 is high.
13	$\overline{\text{ON2}}$	Active-Low Enable Logic Input. Pulling $\overline{\text{ON2}}$ to GND enables the output if $\overline{\text{PRESDT}}$ is low and ON1 is high.
14	CB	Current-Limit Threshold Set. Connect a resistor from CB to GND to set the circuit-breaker threshold.
15	REG	Internal Regulator Output. Bypass to ground with a 1μF capacitor. Do not power external circuitry using the REG output.
16	ON1	Active-High Enable Comparator Input. Pulling ON1 high enables the output if $\overline{\text{PRESDT}}$ and $\overline{\text{ON2}}$ are held low. ON1 also sets the undervoltage threshold. See the <i>Setting the Undervoltage Threshold</i> section.
—	EP	Exposed Pad. EP is internally grounded. Connect externally to ground plane for effective heat dissipation. Do not use as the only ground connection.

# 2.7V to 18V, 7A, Hot-Swap Solution

Functional Diagram

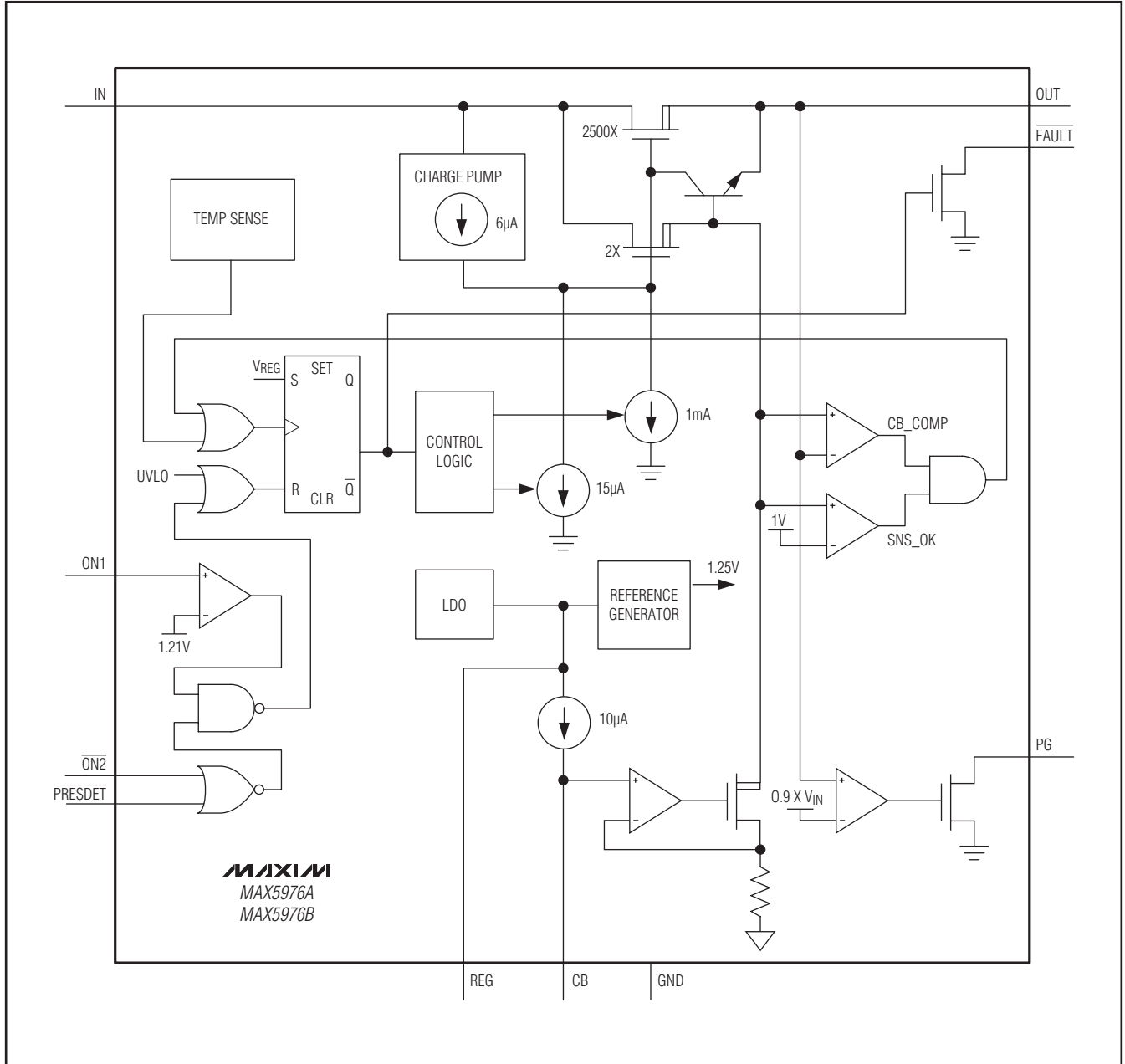

## 2.7V to 18V, 7A, Hot-Swap Solution

### Detailed Description

#### Enable Logic and Undervoltage Lockout Threshold

The MAX5976A/MAX5976B enable the output as shown in Table 1. The ICs turn on the output only when  $V_{ON1}$  is high ( $V_{ON1} > 1.21V$ ) while  $\overline{ON2}$  and  $\overline{PRESD\overline{ET}}$  are low. The devices turn off the output when  $V_{ON1}$  falls below  $1.21V - V_{HYS}$  or whenever  $\overline{ON2}$  or  $\overline{PRESD\overline{ET}}$  are above  $V_{IH}$ . A resistive divider from IN to ON1 and ground provides the flexibility to set the undervoltage lockout threshold to any desired level between  $V_{UVLO}$  and 18V. See Figure 1 and *Setting the Undervoltage Threshold* in the *Applications Information* section.

#### Startup

Once the MAX5976A/MAX5976B output is enabled, the device provides controlled application of power to a load. The voltage at OUT will begin to rise at approximately 18kV/s until the programmed circuit-breaker current level is reached, at which time the MAX5976A/MAX5976B will actively limit inrush current at the circuit-breaker setting.

**Table 1. Output Enable Truth Table**

PRECISION ANALOG INPUT ON1	LOGIC INPUTS		OUT
	$\overline{ON2}$	$\overline{PRESD\overline{ET}}$	
$V_{ON1} > V_{ON1\_TH}$	0	0	ON
$V_{ON1} < (V_{ON1\_TH} - V_{ON\_HYS})$	X	X	OFF
X	1	X	OFF
X	X	1	OFF

X = Don't care.

$V_{ON1\_TH} = 1.21V$  (typ).

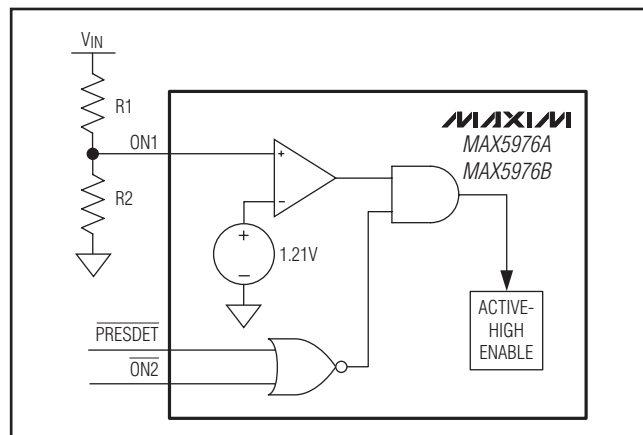

Figure 1. Undervoltage Threshold Setting

Because of this, the inrush current can be easily programmed by appropriate selection of RCB. This startup mode of operation will continue for up to 16ms; after the startup time elapses, the output will either have risen to the IN potential, or if the device is still in current limit, it will shut down and assert the  $\overline{FAULT}$  output low.

The resulting  $dV_{OUT}/dt$  during startup can be determined according to the following equation:

$$dV_{OUT}/dt \approx (I_{CB} - I_{LOAD})/C_{OUT}$$

In this equation,  $I_{LOAD}$  is any current drawn by a load device during the output ramp time that does not charge  $C_{OUT}$ . Make certain that RCB is chosen such that:

$$V_{IN} \times C_{OUT}/(I_{CB} - I_{LOAD}) < 16ms$$

This ensures that the output capacitance can be fully charged before the 16ms startup timer elapses.

An open-drain power-good output goes high-impedance 16ms (typ) after the output has risen to more than 90% of the input voltage to indicate a successful startup.

#### Charge Pump

An integrated charge pump provides the gate-drive voltage for the internal power MOSFET. The charge pump generates +5V potential above  $V_{IN}$  to fully enhance the internal power MOSFET.

#### Circuit-Breaker Comparator

The current through the internal power MOSFET is compared to a circuit-breaker threshold. An external resistor between CB and ground sets this threshold.

The circuit-breaker comparator is designed so that the load current can exceed the threshold for some amount of time before tripping. The time delay varies inversely with the overdrive above the threshold. The greater the overcurrent condition, the faster the response time allowing the devices to tolerate load transients and noise near the circuit-breaker threshold.

The ICs also feature catastrophic short-circuit protection. During normal operation, if OUT is shorted directly to ground, a fast protection circuit forces the gate of the internal MOSFET to discharge quickly and disconnect the output from the input.

#### Autoretry/Latch-Off

During a fault condition, the devices turn off the internal MOSFET disconnecting the output from the input. The MAX5976A enters an autoretry mode with a fixed 250ms lockout time before reconnect can occur. The MAX5976B latches off and remains off until the enable logic is cycled off and on.

## 2.7V to 18V, 7A, Hot-Swap Solution

### Power-Good Delay

The devices feature an open-drain, power-good output that asserts after 16ms (typ), indicating that OUT has reached  $(0.9 \times V_{IN})$  voltage.

### REG

The devices include a linear regulator that outputs 2.6V at REG. REG provides power to the internal circuit blocks of the ICs and must not be loaded externally. REG requires a 1 $\mu$ F capacitor to ground for proper operation.

### Fault Status Output ( $\overline{FAULT}$ )

$\overline{FAULT}$  is an open-drain output that pulls low when a current limit or an overtemperature fault shutdown occurs.  $\overline{FAULT}$  remains low until the next startup cycle.  $\overline{FAULT}$  is capable of sinking up to 5mA when asserted.

### Thermal Protection

The devices enter a thermal shutdown mode in the event of overheating caused by excessive power dissipation or high ambient temperature. When the junction temperature exceeds  $T_J = +150^\circ\text{C}$  (typ), the internal thermal protection circuitry turns off the internal power MOSFET. The devices recover from thermal shutdown mode once the junction temperature drops by  $20^\circ\text{C}$  (typ).

## Applications Information

### Setting the Undervoltage Threshold

The devices feature an independent ON/OFF control (ON1) for the internal MOSFET. The devices operate with a 2.7V to 18V input voltage range and has a default 2.5V (typ) undervoltage lockout threshold. The internal MOSFET remains off as long as  $V_{IN} < 2.5\text{V}$  and/or  $V_{ON1} < V_{ON1\_TH}$ . The undervoltage lockout threshold is programmable using a resistive divider between ON1 and GND (Figure 1). When  $V_{IN}$  is greater than 2.7V and  $V_{ON1}$  exceeds the 1.21V (typ) threshold, the gate of the internal MOSFET enhances to 5V, with respect to  $V_{IN}$  and the

devices' internal switch goes into normal operation. Use the following equation to calculate the resistors values for the desired undervoltage threshold:

$$R1 = \left( \frac{V_{IN}}{V_{ON1\_TH}} - 1 \right) \times R2$$

where  $V_{IN}$  is the desired turn-on voltage for the output and  $V_{ON1}$  is 1.21V. R1 and R2 create a resistive divider from  $V_{IN}$  to ON1. During normal operating conditions,  $V_{ON1}$  must remain above its 1.21V (typ) threshold. If  $V_{ON1}$  falls 100mV ( $V_{ON1\_HYS}$ ) below the threshold, the internal MOSFET turns off, disconnecting the load from the input.

### Setting the Current Limit

An external resistor from CB to ground sets the current limit for the devices. Use the following formula to set the current limit:

$$I_{LIMIT(A)} = \left( \frac{0.175A}{1000\Omega} \right) \times R_{CB(\Omega)}$$

## Chip Information

PROCESS: BiCMOS

## Package Information

For the latest package outline information and land patterns, go to [www.maxim-ic.com/packages](http://www.maxim-ic.com/packages). Note that a "+", "#", or "-" in the package code indicates RoHS status only. Package drawings may show a different suffix character, but the drawing pertains to the package regardless of RoHS status.

PACKAGE TYPE	PACKAGE CODE	OUTLINE NO.	LAND PATTERN NO.
16 TQFN-EP	T1655+3	<a href="#">21-0140</a>	<a href="#">90-0073</a>



## 2.7V to 18V, 7A, Hot-Swap Solution

### Revision History

REVISION NUMBER	REVISION DATE	DESCRIPTION	PAGES CHANGED
0	9/10	Initial release	—
1	4/11	Added the <i>Package Thermal Characteristics</i> and <i>Startup</i> sections.	2, 7

MAX5976A/MAX5976B

Maxim cannot assume responsibility for use of any circuitry other than circuitry entirely embodied in a Maxim product. No circuit patent licenses are implied. Maxim reserves the right to change the circuitry and specifications without notice at any time.

Maxim Integrated Products, 120 San Gabriel Drive, Sunnyvale, CA 94086 408-737-7600 \_\_\_\_\_ 9

# Mouser Electronics

Authorized Distributor

Click to View Pricing, Inventory, Delivery & Lifecycle Information:

[Maxim Integrated:](#)

[MAX5976AETE+](#) [MAX5976BETE+](#) [MAX5976AETE+T](#) [MAX5976BETE+T](#)