

## 1. SOLISTRAND\* TERMINALS AND SPLICES

### SOLISTRAND\* Terminals and Splices

(Refer to pages 4 and 5 for application tooling and accessories).

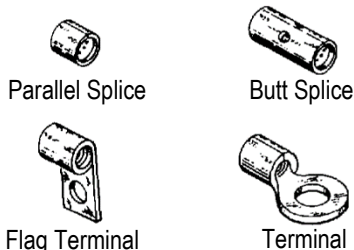

### Pressure Type Wire Connector Chart (Use Type "W" Tooling)

WIRE SIZE RANGE	UL 424C LISTED	SP LR 7189 CERTIFIED
22-16 Solid or Stranded	22-16 Solid or Stranded	22-16 Solid or Stranded
16-14 Solid or Stranded	16-14 Solid or Stranded	16-14 Solid or Stranded
12-10 Solid or Stranded	12-10 Stranded	12-10 Solid or Stranded
8 Thru 600 MCM Solid or Stranded	8 Thru 600 MCM Stranded	8 Thru 4/0 Solid or Stranded

**NOTE:** 22-16 terminals and splices are stamped 22-18 in accordance with MIL-T-7928.

Figure 1

## 1.1. Tool and Die Selections

### A. Hydraulic

Wire Size	Dies for 59973-1, 69065		Dies for 69067		59975-5, 69069 with/Self-Contained Dies	Dies for 48445-1, 1752788-1	Dies for 69082, 1752786-1	Dies for 69097		Dies for 69099, 1752868-1
	Nest	Indenter	Nest	Indenter				Nest	Indenter	
8	48126	48355	48126 <sup>^</sup> 48506 <sup>^</sup>	48355 <sup>^</sup> 48505 <sup>^</sup>	59975-1 69069	---	---	46146	46145	69216
8 H.D.	48128-1	48127-1	48128-1	48127-1	---	---	---	---	---	---
6	48128	48127	48128 <sup>^</sup> 48508 <sup>^</sup>	48127 <sup>^</sup> 48507 <sup>^</sup>	59975-1 69069	---	---	46134	46133	69217
6 H.D.	48129-1	48127-1	48129-1	48127-1	---	---	---	---	---	---
4	48129	48127	48129 <sup>^</sup> 48509 <sup>^</sup>	48127 <sup>^</sup> 48507 <sup>^</sup>	59975-1 69069	---	---	46135	46133	69218
4 H.D.	48130-1	48127-1	48130-1	48127-1	---	---	---	---	---	---
2	48130	48127	48130 <sup>^</sup> 48510 <sup>^</sup>	48127 <sup>^</sup> 48507 <sup>^</sup>	59975-1 69069	---	---	46136	46133	45433
2 H.D.	48132-1	48131-1	48132-1	48131-1	---	---	---	---	---	---
1/0	48132	48131	48132 <sup>^</sup> 48652 <sup>^</sup>	48131 <sup>^</sup> 48511 <sup>^</sup>	---	---	---	46138	46137	45436
1/0 H.D.	48133-1	48131-1	48133-1	48131-1	---	---	---	---	---	---
2/0	48133	---	48133 <sup>^</sup> 48805 <sup>^</sup>	48131 <sup>^</sup> 48511 <sup>^</sup>	---	---	---	---	---	45439
3/0	48134	48131	48134 <sup>^</sup> 48806 <sup>^</sup>	48131 <sup>^</sup> 48511 <sup>^</sup>	---	---	---	---	---	45442
4/0	300430	---	300430 <sup>^</sup> 48807 <sup>^</sup>	48131 <sup>^</sup> 48511 <sup>^</sup>	---	---	---	---	---	45445
250-300 MCM	---	---	---	---	---	48816	69911	---	---	---
300-350 MCM	---	---	---	---	---	48817	69912	---	---	---
400 MCM	---	---	---	---	---	48818	69913	---	---	---
500-600 MCM	---	---	---	---	---	48819	69914	---	---	---

<sup>^</sup> Flag Terminals

Figure 2

**B. Hand Tools**

Wire Size	HAND TOOLS
26-22	69363†
22-18	---
22-16	49935†
16-14	49935†
14-12	49592†
12-10 16-14 H.D.	49935†
	49965† (Flag Only)
8	69339● (Str. Wire)
	69355●
6	59083● (No Ratchet)
4	---
2	---
1/0	---

†Long Handle, ●Heavy Head

Figure 3

**C. Pneumatic and Tape**

Wire Size	PNEUMATIC				TAPE	
	Heads for 626	Heads for 69015	Jaws for 68068-[ ]	Dies for 69710-1	Dies for 69875 •Reversed ••Standard	Dies for 68250-1
26-22	---	---	---	---	68108-1	---
22-18	314516-1 679301-1	---	---	---	---	---
22-16	314516-1 679301-1	---	---	47812	68240-1• 68096-1••	---
16-14	314517-1 679301-1	---	---	47813	68241-1• 68097-1••	---
14-12	314518-1 679301-1	---	---	---	90566-1	---
12-10 16-14 H.D.	679301-1	---	---	47814†	68242-1• 68338-1••	---
8	1338757-1	49956	68135	---	68243-1◇	68312-1◇
		48412●				
6	1338758-1	48172	68136	---	---	68313-1◇
		48413●				
4	---	48173	---	---	---	---
2	---	48174	---	---	---	---
		48415●				
1/0	---	48183	---	---	---	---

● Flag Terminals, † Str. Wire Only, ◇ Single Indent

Figure 4

## 2. AMPOWER\* TERMINALS AND SPLICES

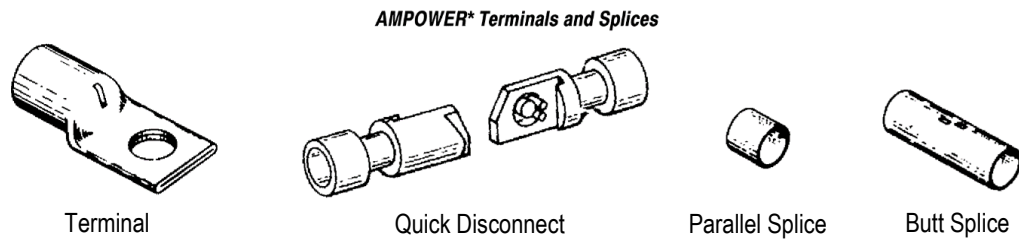

**Pressure Type Wire Connector Chart**  
(Use Type "C" Tooling)

WIRE SIZE RANGE	 <b>424C LISTED</b>	 <b>LR 7189 CERTIFIED</b>
6 thru 1000 MCM	6 thru 1000 MCM Stranded	6 thru 1000 MCM Stranded

Figure 5

### 2.1. Tool and Die Selections

#### A. Hydraulic (Use Power Unit 69120-[ ] or 314979-1)

Wire Size	Dies for 69099 1752868-1	Dies for 69082 1752786-1	Dies for 69065 59973-1	Dies for 58445-1 1752788-1	Dies for 68073-2
6	69133-1	---	---	---	---
4	69134-2	---	---	---	---
2	46765-3	---	46321-3	---	---
1/0	46766-2	---	46322-2	---	---
	68361-1† (with Locator)				
2/0	46767-2	---	46323-2	---	---
	68253-1† (with Locator)				
3/0	46749-2	---	46324-2	---	---
	59867-1† (with Locator)				
4/0	46750-2	---	46325-2	---	---
	68304-1† (with Locator)				
250 MCM	46751-2 68203-1†	---	---	46326-2	---
300 MCM	46752-2	---	---	---	---
350 MCM	46753-2	69653 68204-1†	---	---	---
400 MCM	---	46754-2 68332-1†	---	---	---
500 MCM	---	46755-2 68206-1†	---	---	---
600 MCM	---	46756-2	---	---	---
600 H.D.	---	59870-1	---	---	---
700 MCM	---	46757-2	---	---	---
800 MCM	---	46758-2	---	---	---
900 MCM	---	46759-2	---	---	---
1000 MCM	---	46760-2	---	---	---
1250 MCM	---	---	---	---	68114-1
1500 MCM	---	---	---	---	68282-1

†Quick Disconnect Terminals Only

Figure 6

## Tooling and Accessories

### Hydraulic

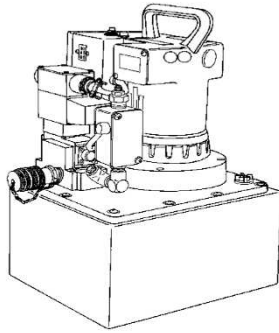

**DYNA-CRIMP\***  
 Hydraulic Power Units  
 69120-1 (115 VAC – 60 Hz)  
 1804700-1 (115 VAC – 60 Hz)  
 69120-2 (230 VAC – 60 Hz)  
 1804700-2 (230 VAC – 60 Hz)

Handle Control w/Hose and  
 Cord 59907-[ ] and 1901775-[ ]



Foot Control  
 68284-1

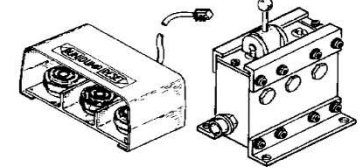

3-Way Multi-  
 directional Valve  
 59220 (No Safety Sw)  
 59220-2 (w/Safety Sw)

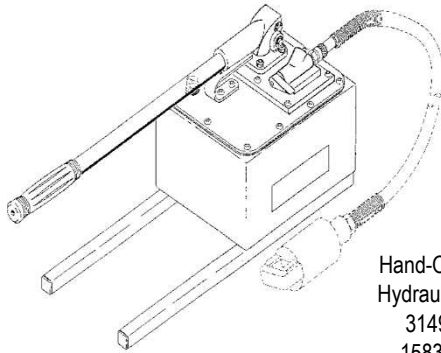

Hand-Operated  
 Hydraulic Pump  
 314979-1  
 1583661-1

Hose Assy w/Crimping  
 Head Coupling  
 59909-[ ], 1583662-[ ]

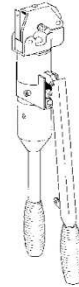

Hand Tool  
 59975-1

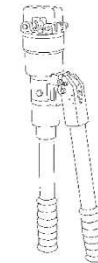

Hand Tool  
 59973-1

### Tape Machines

AMP-TAPETRONIC\*  
 Machine 68250-1

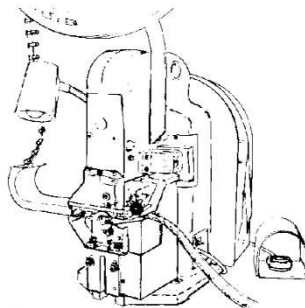

AMP-TAPETRONIC\*  
 Machine 69875

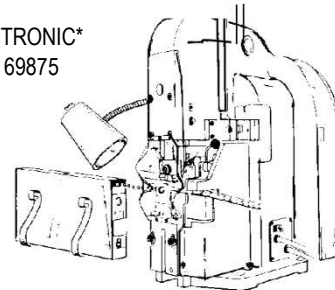

### Pneumatic

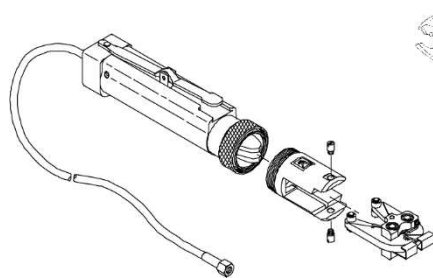

626 Pneumatic Tooling Systems

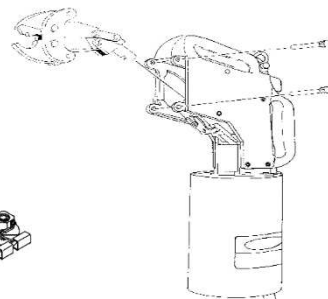

69015

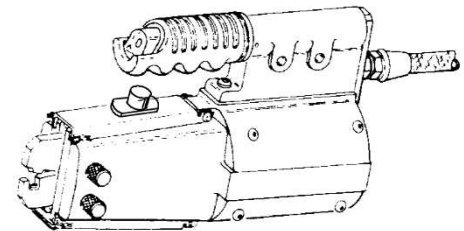

68068

Figure 7

**Tooling and Accessories**

**Hydraulic Crimping Heads**

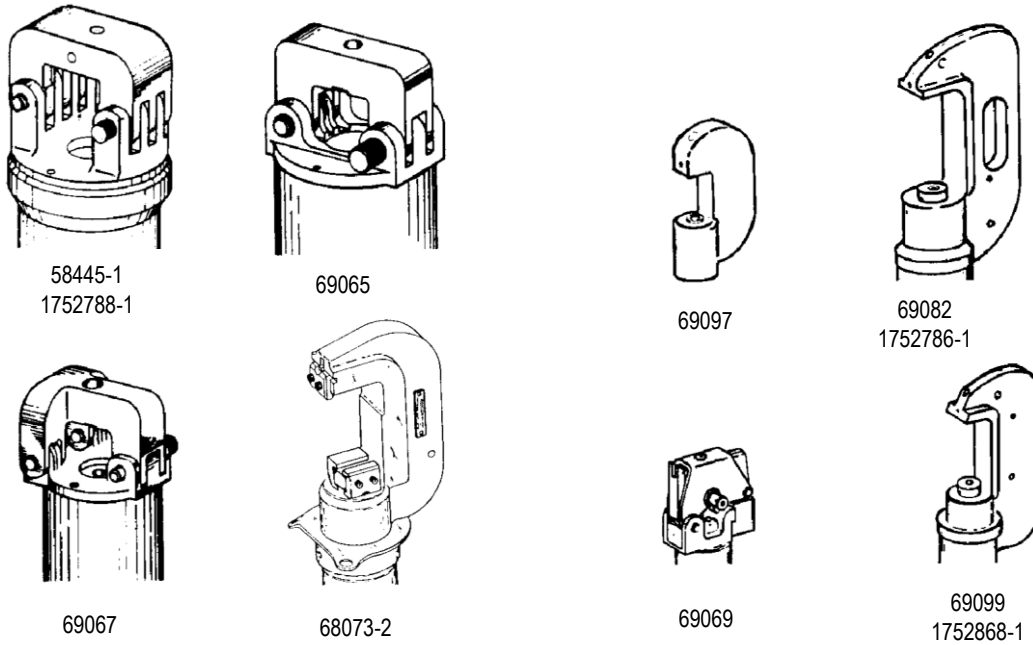

Figure 8

**Hand Tools**

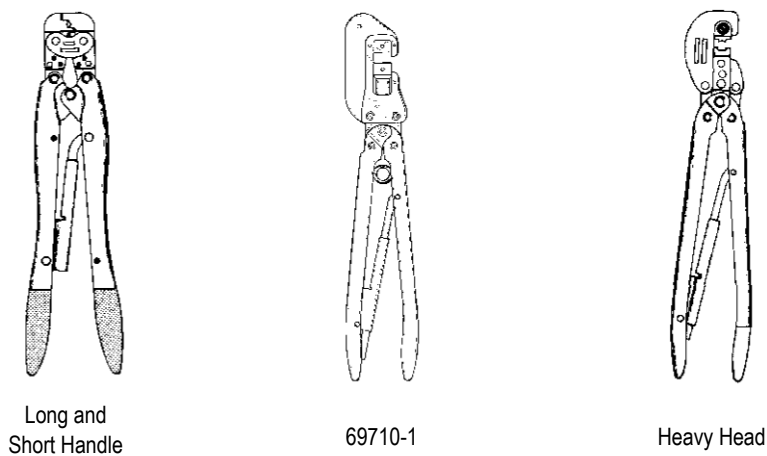

Figure 9

**3. REVISION SUMMARY**

- ◆ All paragraphs revised due to formatting adjustments and editing.
- ◆ Corrections to Figure 6 were made, as follows: added line item for 350 MCM and corrected line item for 400 MCM to match previous revision.

# Mouser Electronics

Authorized Distributor

Click to View Pricing, Inventory, Delivery & Lifecycle Information:

[TE Connectivity:](#)

[47813](#)