

DO NOT SCALE FROM THIS PRINT

SSM-1XX-XXX-DV-XX-XX-XXX-XX

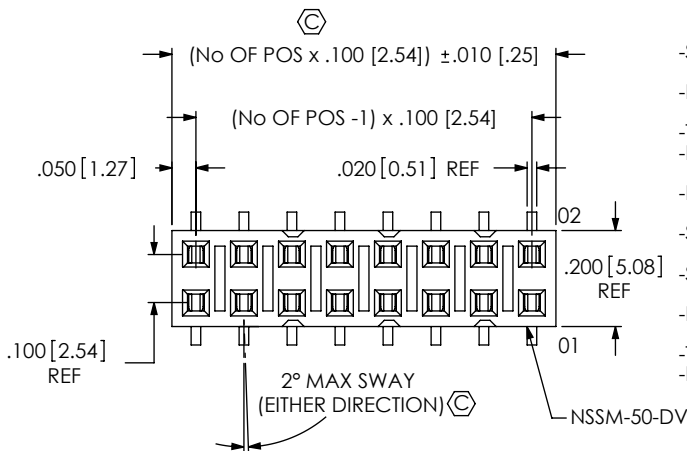

- No OF POSITIONS  
 -02 THRU -40  
 (PER ROW) (SEE NOTE 7)
- PLATING
- S: 30μ" SELECTIVE GOLD IN CONTACT AREA MATTE TIN ON TAIL
  - L: 10μ" LIGHT SELECTIVE GOLD IN CONTACT AREA MATTE TIN ON TAIL
  - T: MATTE TIN CONTACT AND TAIL
  - F: 3μ" FLASH SELECTIVE GOLD CONTACT, MATTE TIN ON TAIL
  - H: 30μ" HEAVY GOLD IN CONTACT AREA 3μ" ON TAIL
  - STL: 30μ" SELECTIVE GOLD IN CONTACT AREA TIN/LEAD (90/10+/-5%) TAIL
  - SM: 30μ" SELECTIVE GOLD IN CONTACT AREA MATTE TIN ON TAIL
  - LM: 10μ" LIGHT SELECTIVE GOLD IN CONTACT AREA MATTE TIN TAIL
  - TM: MATTE TIN CONTACT AND TAIL
  - FM: 3μ" FLASH SELECTIVE GOLD IN CONTACT AREA MATTE TIN TAIL
- OPTION
- P: PICK & PLACE PAD (SEE NOTE 5) (USE PPP-01, SEE FIG 4, SHT 2)
  - M: METAL PICK & PLACE PAD (SEE NOTE 5) (USE LMP-02, SEE FIG 5, SHT 2)
  - K: POLYIMIDE FILM PAD (POS 2 THROUGH 40 - SEE NOTE 5) (USE K-DOT-.256-.375-.005, SEE FIG 6, SHT 2)
  - TR: TAPE & REEL (SEE FIG 8, SHT 2-29 POSITIONS MAX)
- POLARIZING OPTION
- XXX: POSITION TO BE POLARIZED (USE PK-15-N) (SEE FIG 7, SHT 2) (NOT AVAILABLE WITH -BE OPTION)
- MOUNTING OPTION
- A: ALIGNMENT PIN (SEE FIG 3, SHT 2) (MOLDED: USE NSSM-XX-DV-XX, 4 POS MIN)
  - LC: LOCKING CLIP (USE LC-05-TM) (SEE FIG 2) (SEE NOTE 8)
- OPTION
- BE: BOTTOM ENTRY (ONLY AVAILABLE ON -DV) (FOR -DV SEE NSSM-50-DV-XX)

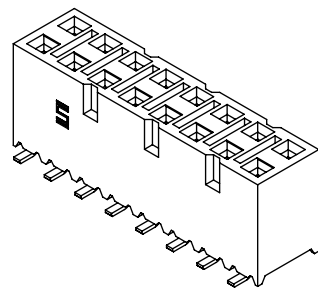
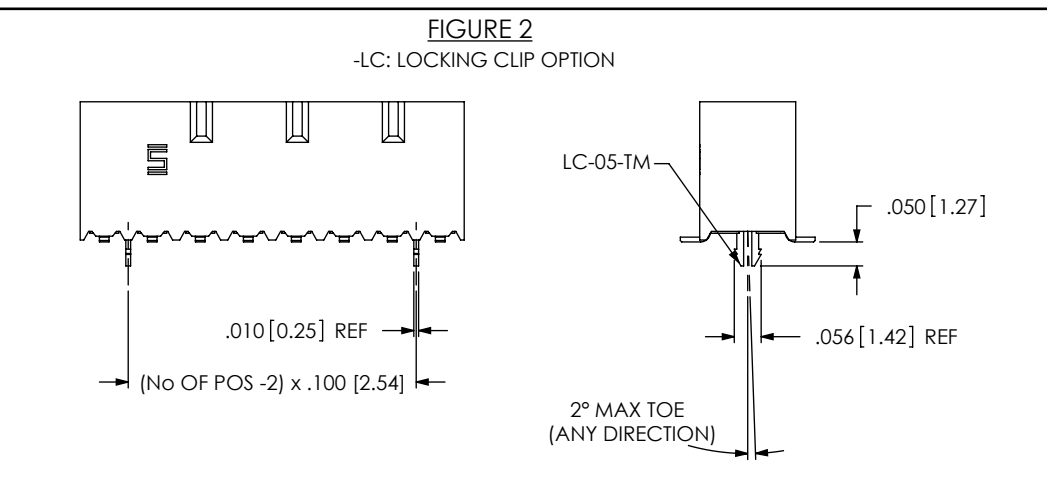
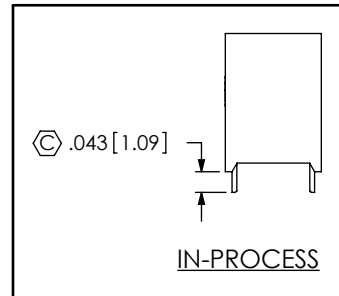
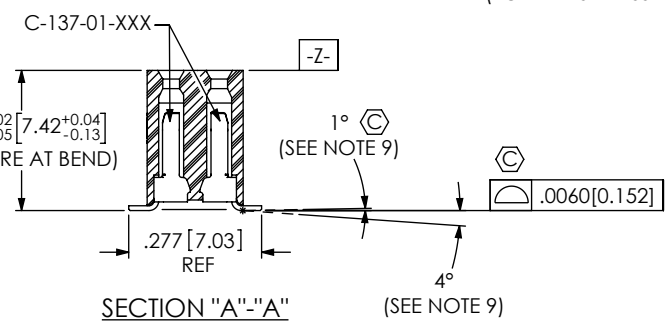
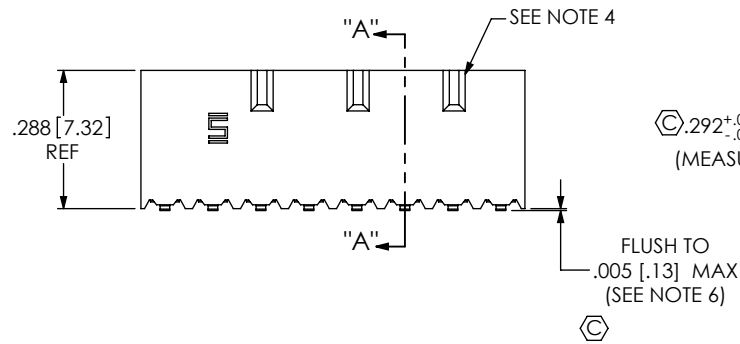

- NOTES:
- Ⓢ REPRESENTS A CRITICAL DIMENSION.
  - MINIMUM PULLOUT FORCE: .50 LBS
  - MAXIMUM CUT FLASH: .010 [0.25]
  - CUT PARTS MAY OR MAY NOT HAVE NOTCHES
  - P OPTION: 4 POSITION AND UNDER TO BE -T/R
  - M OPTION: 3 POSITION AND UNDER TO BE -T/R
  - K OPTION: 3 POSITION AND UNDER TO BE -T/R
  - ALL OTHER POSITIONS WITH -P, -M, -K OPTIONS ARE TO BE TUBED, UNLESS -TR ORDERED BY CUSTOMER.
  - FLUSH DIMENSION MUST BE INSPECTED ON BOTH ROWS OF ASSEMBLY.
  - 40 MAX POSITION AVAILABLE, -50 FOR STOCK ONLY
  - DUE TO THE HIGH AMOUNT OF INSERTION FORCE NEEDED, THE -LC OPTION IS NOT COMPATIBLE WITH AUTO PLACEMENT. SAMTEC RECOMMENDS MANUAL PLACEMENT FOR ALL ASSEMBLIES WITH THE -LC OPTION.
  - THIS DIMENSION IS TO BE MEASURED RELATIVE TO DATUM -Z-

UNLESS OTHERWISE SPECIFIED, DIMENSIONS ARE IN INCHES.

TOLERANCES ARE:

DECIMALS	ANGLES
.XX: ±.01 [0.3]	2°
.XXX: ±.005 [0.13]	
.XXXX: ±.0020 [0.051]	

PROPRIETARY NOTE  
 \* THIS DOCUMENT CONTAINS CONFIDENTIAL AND PROPRIETARY INFORMATION AND ALL DESIGN, MANUFACTURING, REPRODUCTION, USE, PATENT RIGHTS AND SALES RIGHTS ARE EXPRESSLY RESERVED BY SAMTEC, INC. THIS DOCUMENT SHALL NOT BE DISCLOSED, IN WHOLE OR PART, TO ANY UNAUTHORIZED PERSON OR ENTITY NOR REPRODUCED, TRANSFERRED OR INCORPORATED IN ANY OTHER PROJECT IN ANY MANNER WITHOUT THE EXPRESS WRITTEN CONSENT OF SAMTEC, INC.

520 PARK EAST BLVD, NEW ALBANY, IN 47150  
 PHONE: 812-944-6733 FAX: 812-948-5047  
 e-Mail info@SAMTEC.com code 55322

MATERIAL: DO NOT SCALE DRAWING SHEET SCALE: 1:0.4  
 BODY: LCP UL 94 VO, COLOR: BLACK  
 CONTACT: PHOS BRONZE

DESCRIPTION:  
 .100 C.L. DOUBLE VERTICAL SMT SOCKET STRIP  
 DWG. NO.  
**SSM-1XX-XXX-DV-XX-XX-XXX-XX**

**FIGURE 3**  
-A: ALIGNMENT PIN  
MOLDED (4 POSITION MIN)

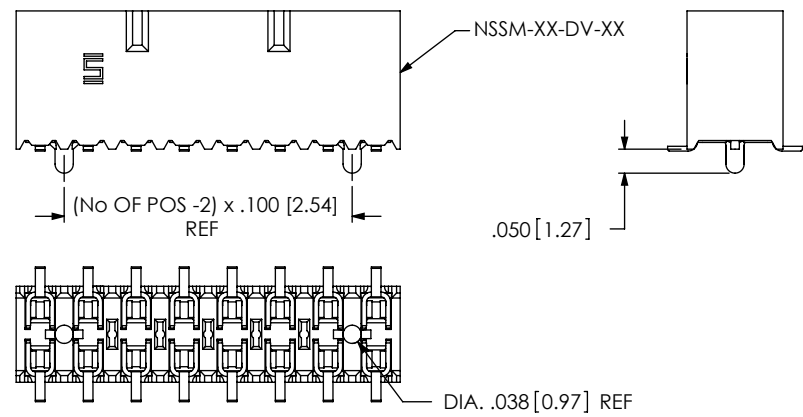

**FIGURE 8**  
TAPE & REEL VIEW

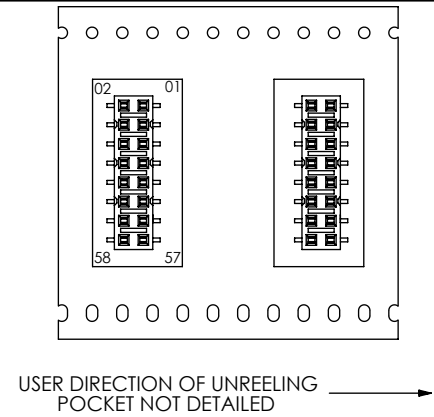

**FIGURE 4**

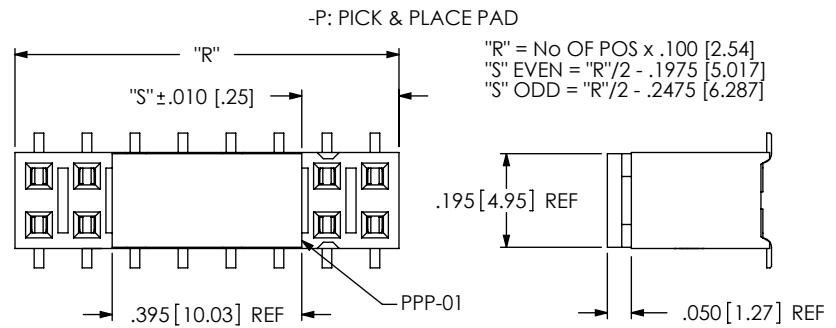

**FIGURE 6**

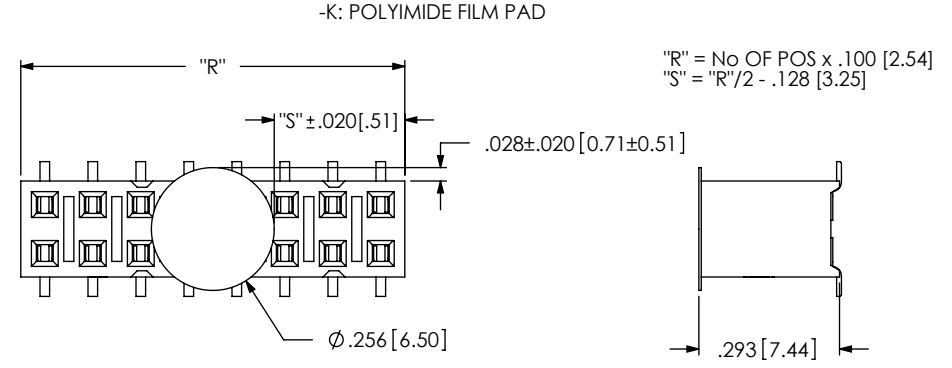

**FIGURE 5**

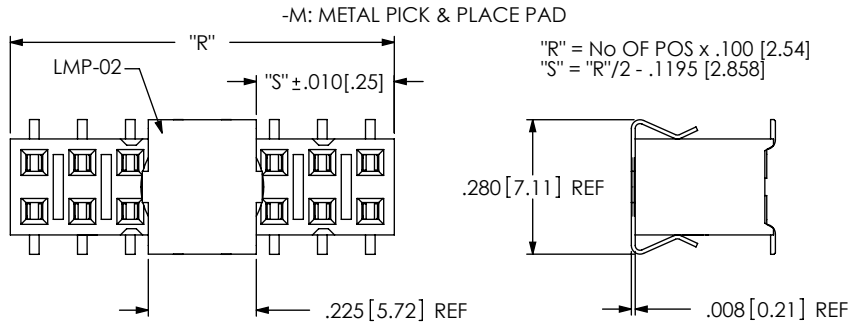

**TABLE 1**

OPTION	PACKAGING TUBE	PLUG	POSITIONS ALLOWED
-K, -M -LC-K, -LC-M, -A-K, NONE, -LC, -A, -P-LC, -P	PT-1-24-01-103 PT-1-24-03-15	TP-07 TP-03	02 THRU 40 02 THRU 40

PT-1-24-03-15

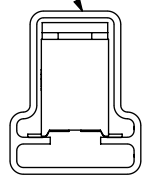

PT-1-24-01-103

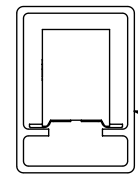

**FIGURE 7**  
POLARIZING POSITIONS

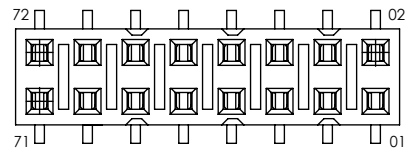

**PROPRIETARY NOTE**  
THIS DOCUMENT CONTAINS CONFIDENTIAL AND PROPRIETARY INFORMATION AND ALL DESIGN, MANUFACTURING, REPRODUCTION, USE, PATENT RIGHTS AND SALES RIGHTS ARE EXPRESSLY RESERVED BY SAMTEC, INC. THIS DOCUMENT SHALL NOT BE DISCLOSED, IN WHOLE OR PART, TO ANY UNAUTHORIZED PERSON OR ENTITY NOR REPRODUCED, TRANSFERRED OR INCORPORATED IN ANY OTHER PROJECT IN ANY MANNER WITHOUT THE EXPRESS WRITTEN CONSENT OF SAMTEC, INC.

DO NOT SCALE DRAWING

SHEET SCALE: 1:0.4



520 PARK EAST BLVD. NEW ALBANY, IN 47150  
PHONE: 812-944-6733 FAX: 812-948-5047  
e-Mail info@SAMTEC.com code 55322

DESCRIPTION:  
.100 C.L. DOUBLE VERTICAL SMT SOCKET STRIP

DWG. NO.  
**SSM-1XX-XXX-DV-XX-XX-XXX-XX**

BY: KEVIN B 3/8/2000 SHEET 2 OF 2