

THIS DRAWING IS UNPUBLISHED. RELEASED FOR PUBLICATION .19
 © COPYRIGHT 19 BY - ALL RIGHTS RESERVED.

LOC	DIST	REVISIONS				
P	LTR	DESCRIPTION	DATE	DWN	APVD	
DY	-	F2	REVISED PER ECO-11-005139	19MAR11	RK	HMR

NOTES:

- 1 MATERIAL:
 HOUSING: GLASS FILLED HIGH TEMP NYLON, NATURAL COLOR (BEIGE)
 CONTACT: PHOSPHOR BRONZE
 SOLDER PEG: BRASS
- 2 FINISH: MATTE TIN OVER NICKEL UNDERPLATE
- 3. PACKAGING: TAPE & REEL (PACKAGING SPEC: 107-51189)

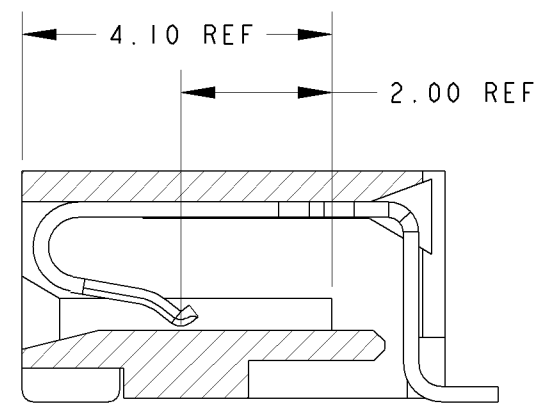
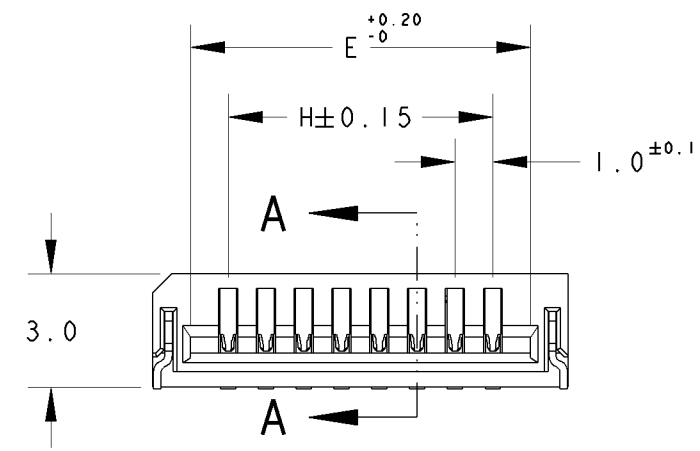
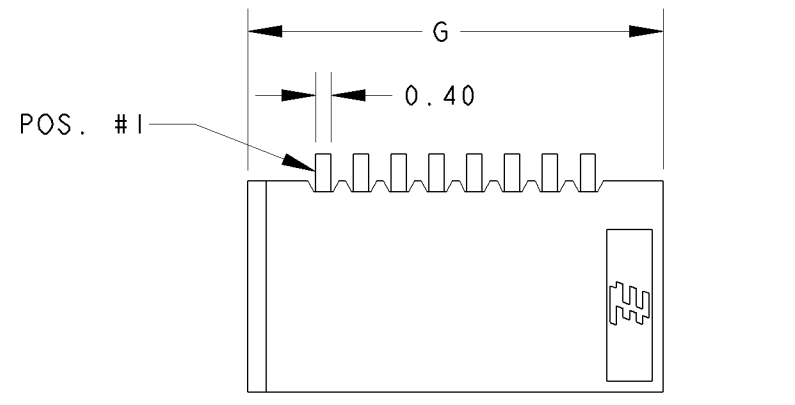

SECTION A-A
SCALE 10:1

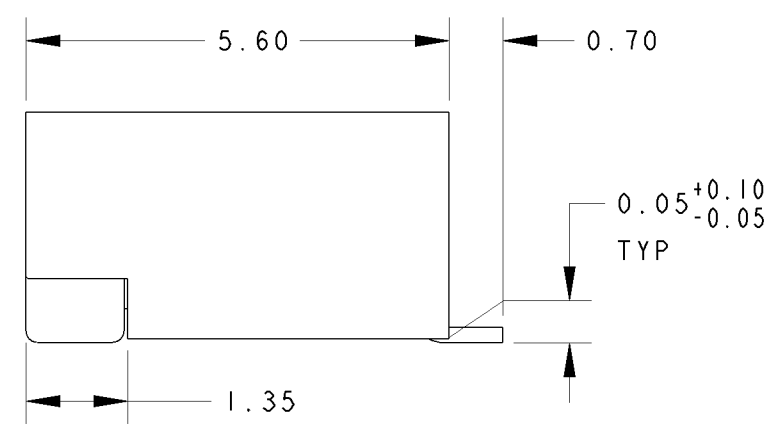
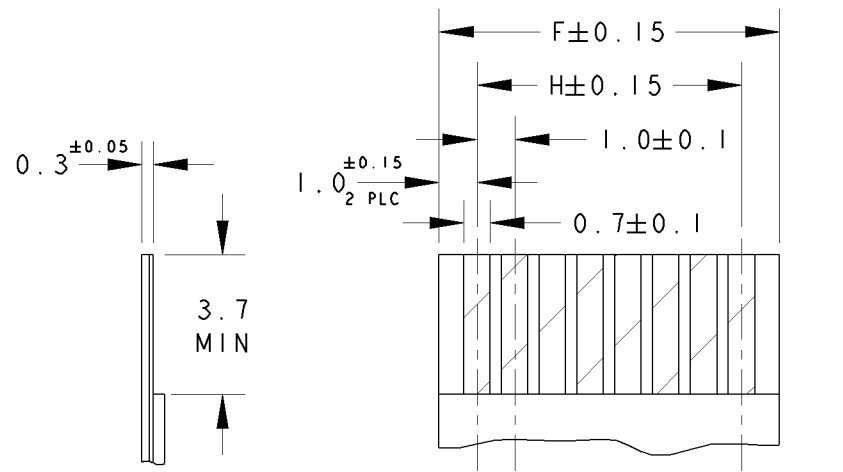

SCALE 10:1

29.00	33.00	31.00	31.00	30	3-84981-0
28.00	32.00	30.00	30.00	29	2- -9
27.00	31.00	29.00	29.00	28	2- -8
26.00	30.00	27.00	27.00	27	2- -7
25.00	29.00	27.00	27.00	26	2- -6
24.00	28.00	26.00	26.00	25	2- -5
23.00	27.00	25.00	25.00	24	2- -4
22.00	26.00	24.00	24.00	23	2- -3
21.00	25.00	23.00	23.00	22	2- -2
20.00	24.00	22.00	22.00	21	2- -1
19.00	23.00	21.00	21.00	20	2-84981-0
18.00	22.00	20.00	20.00	19	1- -9
17.00	21.00	19.00	19.00	18	1- -8
16.00	20.00	18.00	18.00	17	1- -7
15.00	19.00	17.00	17.00	16	1- -6
14.00	18.00	16.00	16.00	15	1- -5
13.00	17.00	15.00	15.00	14	1- -4
12.00	16.00	14.00	14.00	13	1- -3
11.00	15.00	13.00	13.00	12	1- -2
10.00	14.00	12.00	12.00	11	1- -1
9.00	13.00	11.00	11.00	10	1-84981-0
8.00	12.00	10.00	10.00	9	-9
7.00	11.00	9.00	9.00	8	-8
6.00	10.00	8.00	8.00	7	-7
5.00	9.00	7.00	7.00	6	-6
4.00	8.00	6.00	6.00	5	-5
3.00	7.00	5.00	5.00	4	84981-4
H	G	F	E	POS.	PART NO.

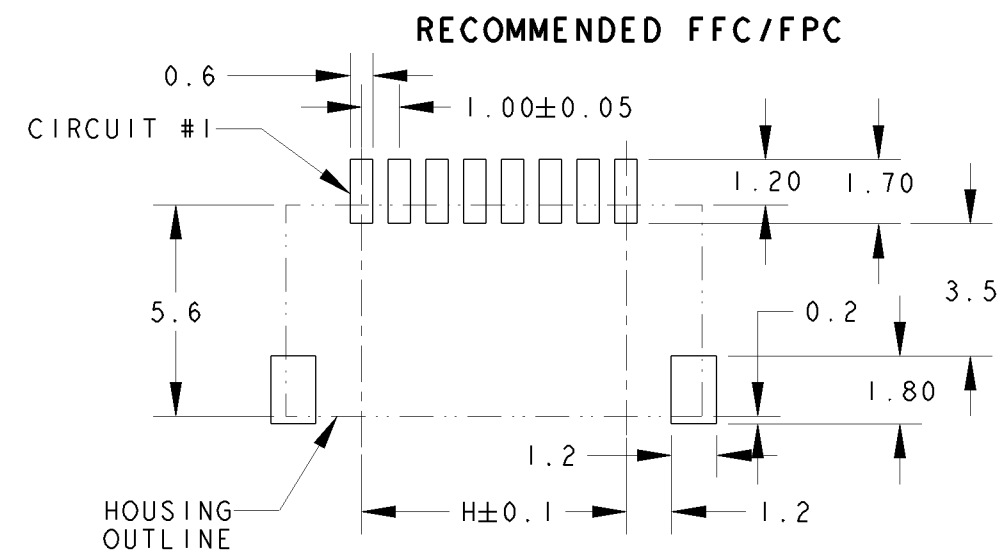

RECOMMENDED PCB LAYOUT
(NON-ACCUMULATIVE TOLERANCE)

DIMS: mm		TOLERANCES UNLESS OTHERWISE SPECIFIED:		DWN WYLEE 10JUN04		TE Connectivity	
		0 PLC ±0.30 1 PLC ±0.30 2 PLC ±0.30 3 PLC ± 4 PLC ± ANGLES ±3°		CHK LP TAN			
MATERIAL		FINISH		APVD SF LEONG		SIZE A3	
1		2		PRODUCT SPEC 108-51054		CAGE CODE 00779	
				APPLICATION SPEC -		DRAWING NO C-84981	
				WEIGHT -		SCALE 5:1	
				CUSTOMER DRAWING		SHEET 1 OF 1	
						REV F2	

Mouser Electronics

Authorized Distributor

Click to View Pricing, Inventory, Delivery & Lifecycle Information:

[TE Connectivity:](#)

[1-84981-3](#)