

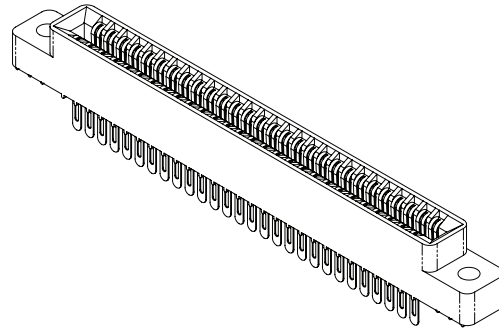

.100" [2.54 mm] Contact Centers, .431" [10.95 mm] Insulator Height, Dip Solder/Eyelet/Right Angle for .093" [2.36 mm] Mating PCB

SPECIFICATIONS

- Accommodates .093" ± .008" [2.36 mm ± 0.20 mm] PC board
- PBT, PPS, PA9T, or PEEK insulator
- Molded-in key available
- 3 Amps current rating for one contact energized
- 30 milli Ohms maximum at rated current
- UL Flammability Rating: 94V-0



READOUT

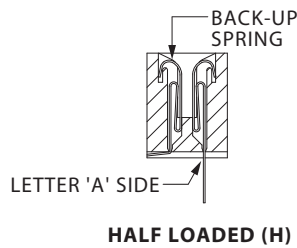
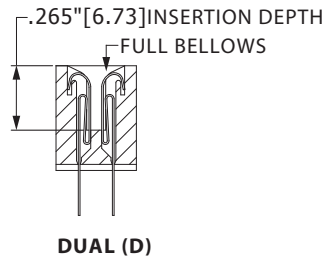

Female Card Edge

TERMINATION TYPE

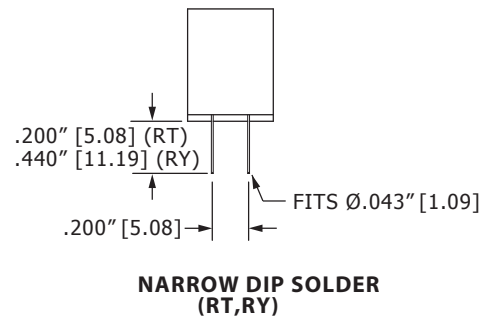
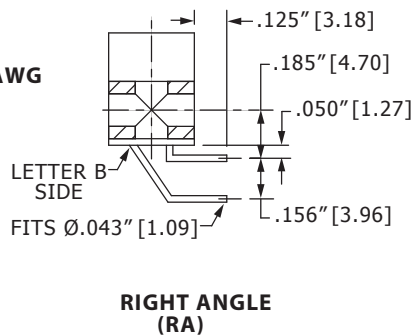
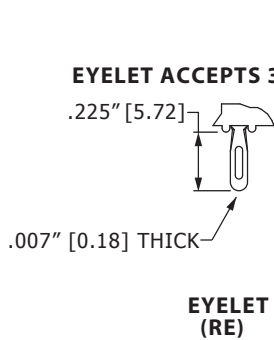

MOUNTING STYLE

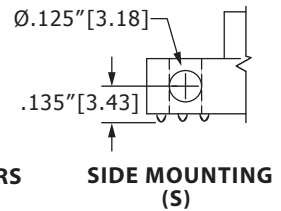
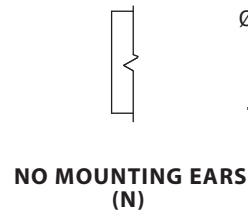
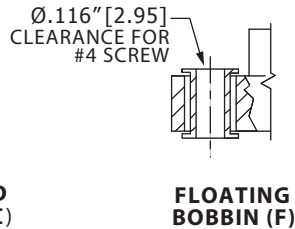
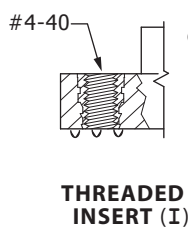
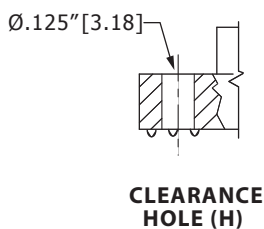



.100" [2.54 mm] Contact Centers, .431" [10.95 mm] Insulator Height, Dip Solder/Eyelet/Right Angle for .093" [2.36 mm] Mating PCB

PART NUMBER OPTIONS

MATERIALS (INSULATOR/CONTACT)

- E = PBT/Phosphor Bronze (Standard)
- R = PPS/Phosphor Bronze
- G = PA9T/Phosphor Bronze
- H = PBT/Beryllium Copper
- A = PPS/Beryllium Copper
- J = PA9T/Beryllium Copper
- *F = PPS/Spinodal (Overall Gold Plating Only)
Consult Factory for Special Soldering Guidelines
- *C = PPS/Beryllium Nickel (Overall Gold Plating Only)
- *W = PEEK/Beryllium Nickel (Overall Gold Plating Only)
- *Consult factory for availability.
- Refer to Page 7 for Operating/Processing Temperatures

CONTACT FINISH - RoHS Compliant

All platings are Lead Free and have .000050" Nickel underplate

Contact Surface	Termination
B = .000010" Gold	.000100" Pure Tin, Matte
C = .000030" Gold	.000100" Pure Tin, Matte
G = .000010" Gold	.000005" Gold
Y = .000030" Gold	.000005" Gold
Contact Surface	Overall Plating
S = .000010" Gold	.000010" Gold
M = .000030" Gold	.000010" Gold
E = .000100" Pure Tin, Matte	.000100" Pure Tin, Matte

E B C 43 D RE H - S93

MODIFICATION (Consult Factory)

-S93 = .093" ± .008" [2.36 mm ± 0.20 mm] PCB, .200" [5.08 mm] Row Spacing (RT, RY)

MOUNTING STYLE (Opposite Page)

- H = .125" [3.18 mm] Clearance Holes
- N = No Mounting
- S = Side Mounting
- I = Threaded Insert
- F = Floating Bobbin

TERMINATION TYPE (Opposite Page)

- RA = Right Angle
- RE = Eyelet
- RT = .200" [5.08 mm] X .200" [5.08 mm] Dip Solder
- RY = .200" [5.08 mm] X .440" [11.19 mm] Dip Solder

READOUT (Opposite Page)

- D = Dual
- H = Half Loaded

NUMBER OF CONTACT POSITIONS

See Chart Below

CONTACT CENTERS

- C = .100" [2.54 mm]

DIMENSIONS Dimensions in [] are in millimeters, all others are in inches.

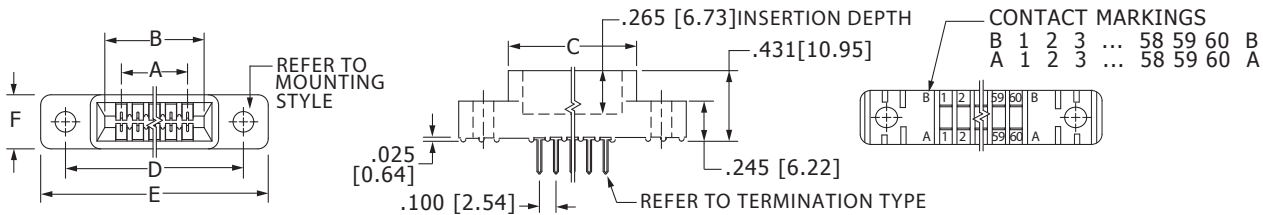

Tolerances on non-critical dimensions may vary slightly due to shrinkage differential per insulator material; Consult factory.

POSITIONS/ CONTACTS	INCHES						MILLIMETERS					
	A±.008	B±.008	C±.015	D±.010	E±.020	F+/.005/-0.015	A±0.20	B±0.20	C±0.38	D±0.25	E±0.51	F+0.13/-0.38
04/08*	0.300	0.500	0.675	0.975	1.275	0.330	7.62	12.70	17.15	24.77	32.39	8.38
05/10	0.400	0.600	0.775	1.075	1.375		10.16	15.24	19.69	27.31	34.93	
06/12	0.500	0.700	0.875	1.175	1.475		12.70	17.78	22.23	29.85	37.47	
07/14	0.600	0.800	0.975	1.275	1.575		15.24	20.32	24.77	32.39	40.01	
08/16	0.700	0.900	1.075	1.375	1.675		17.78	22.86	27.31	34.93	42.55	
10/20	0.900	1.100	1.275	1.575	1.875		22.86	27.94	32.39	40.01	47.63	
12/24	1.100	1.300	1.475	1.775	2.075		27.94	33.02	37.47	45.09	52.71	
13/26	1.200	1.400	1.575	1.875	2.175		30.48	35.56	40.01	47.63	55.25	
15/30	1.400	1.600	1.775	2.075	2.375		35.56	40.64	45.09	52.71	60.33	
17/34	1.600	1.800	1.975	2.275	2.575		40.64	45.72	50.17	57.79	65.41	
18/36	1.700	1.900	2.075	2.375	2.675		43.18	48.26	52.71	60.33	67.95	
19/38	1.800	2.000	2.175	2.475	2.775		45.72	50.80	55.25	62.87	70.49	
20/40	1.900	2.100	2.275	2.575	2.875		48.26	53.34	57.79	65.41	73.03	
22/44	2.100	2.300	2.475	2.775	3.075		53.34	58.42	62.87	70.49	78.11	
23/46*	2.200	2.400	2.575	2.875	3.175		55.88	60.96	65.41	73.03	80.65	
25/50	2.400	2.600	2.775	3.075	3.375		60.96	66.04	70.49	78.11	85.73	
26/52	2.500	2.700	2.875	3.175	3.475		63.50	68.58	73.03	80.65	88.27	
28/56	2.700	2.900	3.075	3.375	3.675		68.58	73.66	78.11	85.73	93.35	
30/60	2.900	3.100	3.275	3.575	3.875		73.66	78.74	83.19	90.81	98.43	
31/62	3.000	3.200	3.375	3.675	3.975		76.20	81.28	85.73	93.35	100.97	
35/70	3.400	3.600	3.775	4.075	4.375	86.36	91.44	95.89	103.51	111.13		
36/72	3.500	3.700	3.875	4.175	4.475	88.90	93.98	98.43	106.05	113.67		
40/80	3.900	4.100	4.275	4.575	4.875	99.06	104.14	108.59	116.21	123.83		
43/86	4.200	4.400	4.575	4.875	5.175	106.68	111.76	116.21	123.83	131.45		
44/88	4.300	4.500	4.675	4.975	5.275	109.22	114.30	118.75	126.37	133.99		
49/98	4.800	5.000	5.175	5.475	5.775	121.92	127.00	131.45	139.07	146.69		
50/100	4.900	5.100	5.275	5.575	5.875	124.46	129.54	133.99	141.61	149.23		
52/104*	5.100	5.300	5.475	5.775	6.075	129.54	134.62	139.07	146.69	154.31		
60/120	5.900	6.100	6.275	6.575	6.875	149.86	154.94	159.39	167.01	174.63		
65/125	6.400	6.600	6.775	7.075	7.375	162.56	167.64	172.09	179.71	187.33		
						0.400					10.16	

* Consult factory for availability.