

LOW DROP POWER SCHOTTKY RECTIFIER

MAIN PRODUCT CHARACTERISTICS

$I_{F(AV)}$	15 A
V_{RRM}	25 V
$T_j(max)$	150 °C
$V_F(max)$	0.35 V

FEATURES

- VERY LOW FORWARD VOLTAGE DROP FOR LESS POWER DISSIPATION AND REDUCED HEATSINK
- OPTIMIZED CONDUCTION/REVERSE LOSSES TRADE-OFF WHICH MEANS THE HIGHEST EFFICIENCY IN THE APPLICATIONS
- AVALANCHE CAPABILITY SPECIFIED

DESCRIPTION

Single Schottky rectifier suited for Switched Mode Power Supplies and high frequency DC to DC converters (V_{RMS}).

Packaged in TO-220AC or D²PAK, this device is especially intended for use as a Rectifier at the secondary of 3.3V SMPS and DC/DC units.

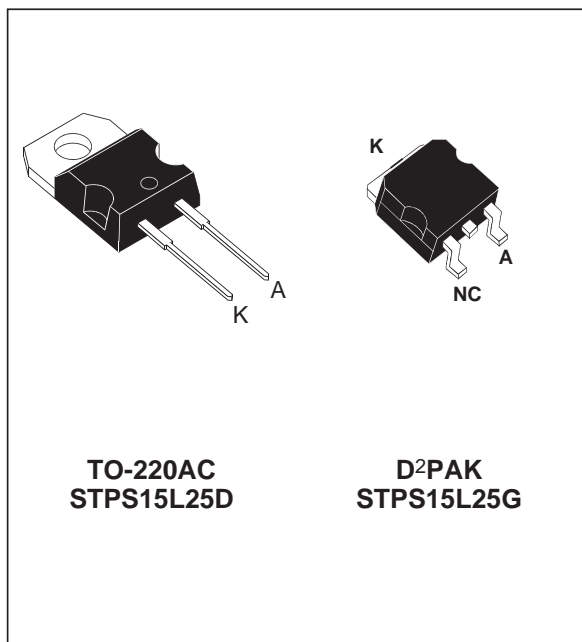

**TO-220AC
STPS15L25D**

**D²PAK
STPS15L25G**

ABSOLUTE RATINGS (limiting values)

Symbol	Parameter	Value	Unit
V_{RRM}	Repetitive peak reverse voltage	25	V
$I_{F(RMS)}$	RMS forward current	30	A
$I_{F(AV)}$	Average forward current	$T_c = 145^\circ\text{C} \quad \delta = 0.5$ 15	A
I_{FSM}	Surge non repetitive forward current	$t_p = 10\text{ms Sinusoidal}$ 250	A
I_{RRM}	Repetitive peak reverse current	$t_p = 2\mu\text{s square } F=1\text{kHz}$ 1	A
I_{RSM}	Non repetitive peak reverse current	$t_p = 100\mu\text{s square}$ 4	A
P_{ARM}	Repetitive peak avalanche power	$t_p = 1\mu\text{s } T_j = 25^\circ\text{C}$ 9000	W
T_{stg}	Storage temperature range	- 65 to + 150	°C
T_j	Maximum operating junction temperature *	150	°C
dV/dt	Critical rate of rise of reverse voltage	10000	V/ μs

* : $\frac{dP_{tot}}{dT_j} < \frac{1}{R_{th(j-a)}}$ thermal runaway condition for a diode on its own heatsink

STPS15L25D/G

THERMAL RESISTANCES

Symbol	Parameter	Value	Unit
$R_{th(j-c)}$	Junction to case	1	°C/W

STATIC ELECTRICAL CHARACTERISTICS

Symbol	Parameters	Test conditions		Min.	Typ.	Max.	Unit
I_R *	Reverse leakage current	$T_j = 25^\circ\text{C}$	$V_R = V_{RRM}$			1.3	mA
		$T_j = 125^\circ\text{C}$			225	450	mA
V_F *	Forward voltage drop	$T_j = 25^\circ\text{C}$	$I_F = 15\text{A}$			0.46	V
		$T_j = 125^\circ\text{C}$	$I_F = 15\text{A}$		0.3	0.35	
		$T_j = 25^\circ\text{C}$	$I_F = 30\text{A}$			0.56	
		$T_j = 125^\circ\text{C}$	$I_F = 30\text{A}$		0.41	0.46	

Pulse test : * $t_p = 380 \mu\text{s}$, $\delta < 2\%$

To evaluate the maximum conduction losses use the following equation :

$$P = 0.24 \times I_{F(AV)} + 0.0073 I_{F(RMS)}^2$$

Fig. 1: Average forward power dissipation versus average forward current.

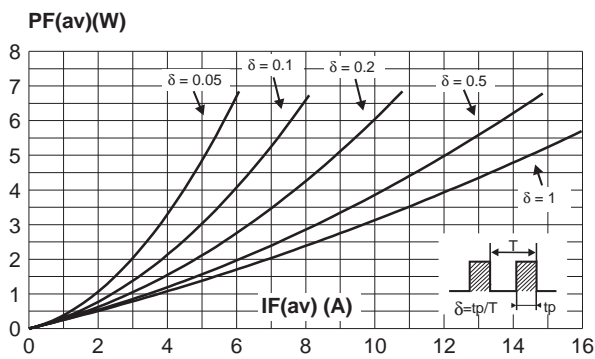

Fig. 3: Normalized avalanche power derating versus pulse duration.

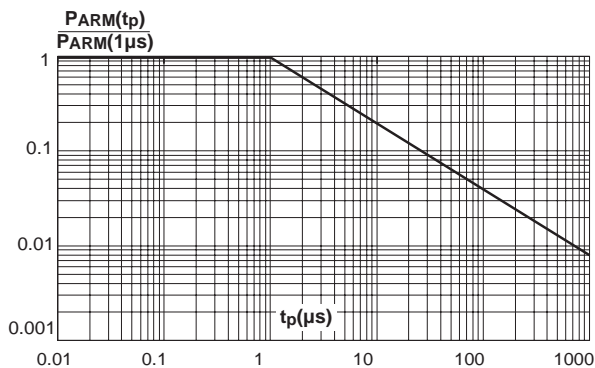

Fig. 2: Average forward current versus ambient temperature ($\delta = 0.5$).

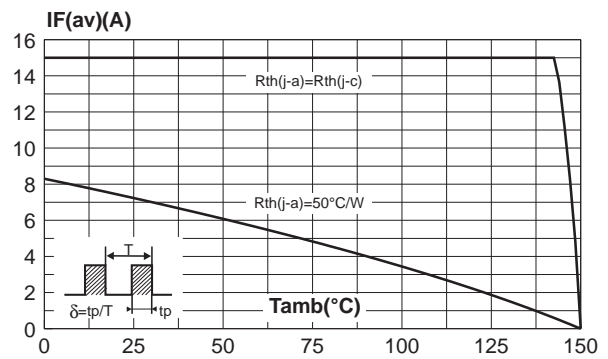

Fig. 4: Normalized avalanche power derating versus junction temperature.

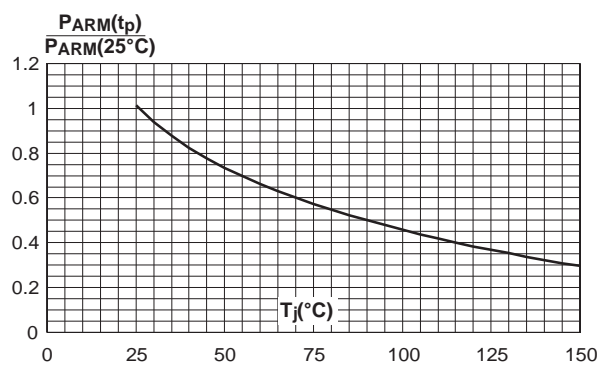

Fig. 5: Non repetitive surge peak forward current versus overload duration (maximum values).

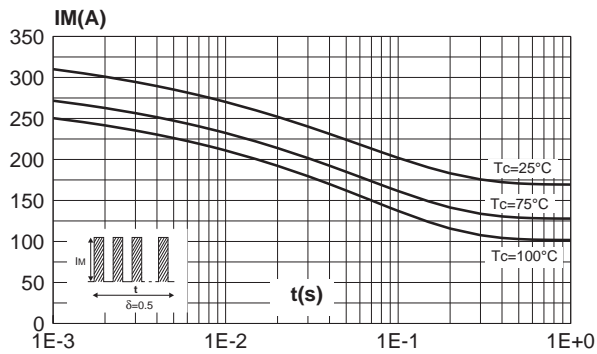

Fig. 6: Relative variation of thermal impedance junction to case versus pulse duration.

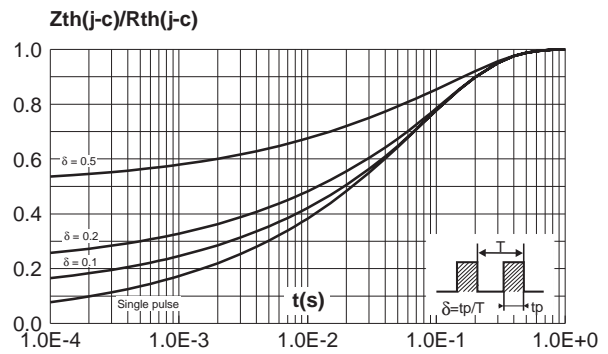

Fig. 7: Reverse leakage current versus reverse voltage applied (typical values).

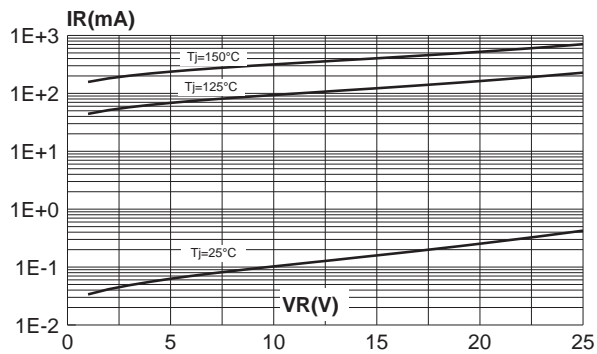

Fig. 8: Junction capacitance versus reverse voltage applied (typical values).

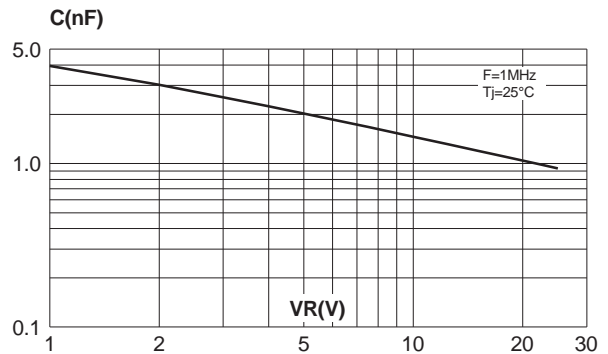

Fig. 9: Forward voltage drop versus forward current (maximum values).

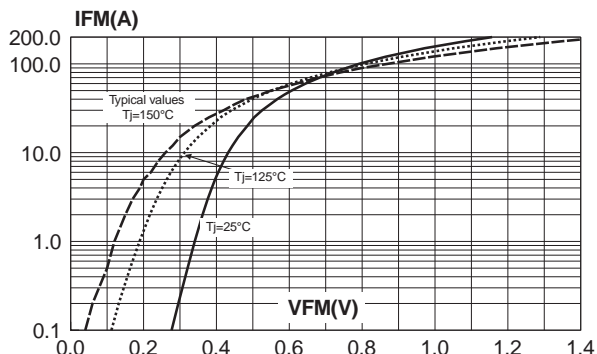
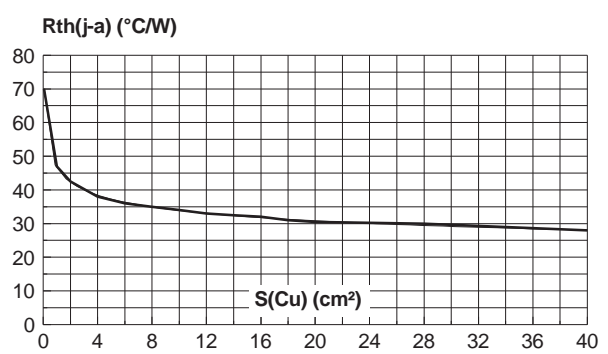
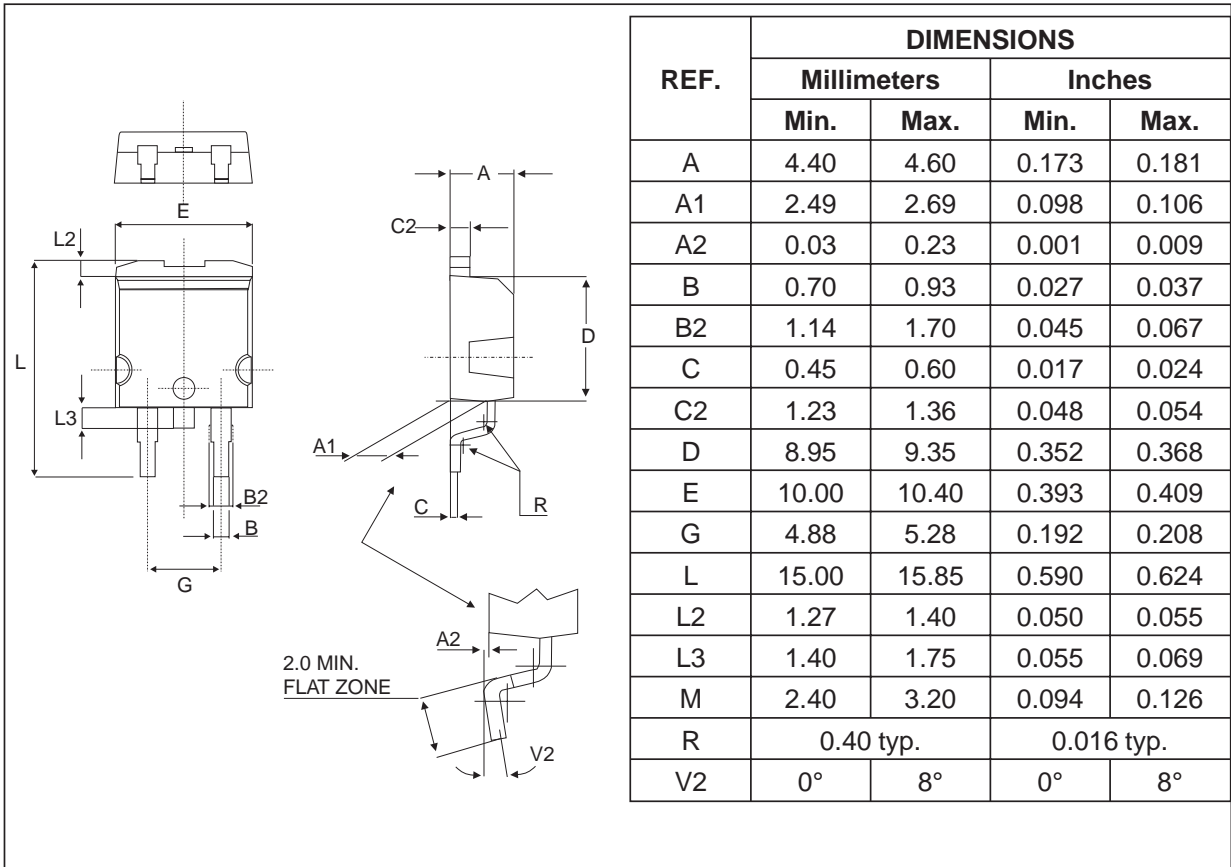

Fig. 10: Thermal resistance junction to ambient versus copper surface under tab (Epoxy printed circuit board FR4, copper thickness : 35 μm). (STPS15L25G only)



STPS15L25D/G

PACKAGE MECHANICAL DATA
D²PAK



FOOT PRINT DIMENSIONS (in millimeters)

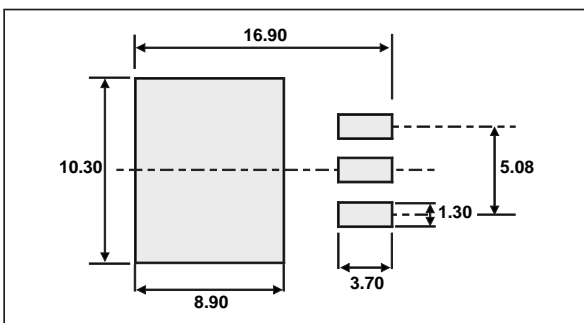

• COOLING METHOD: BY CONDUCTION (METHOD C)

PACKAGE MECHANICAL DATA
 TO-220AC

REF.	DIMENSIONS			
	Millimeters		Inches	
	Min.	Max.	Min.	Max.
A	4.40	4.60	0.173	0.181
C	1.23	1.32	0.048	0.051
D	2.40	2.72	0.094	0.107
E	0.49	0.70	0.019	0.027
F	0.61	0.88	0.024	0.034
F1	1.14	1.70	0.044	0.066
G	4.95	5.15	0.194	0.202
H2	10.00	10.40	0.393	0.409
L2	16.40 typ.		0.645 typ.	
L4	13.00	14.00	0.511	0.551
L5	2.65	2.95	0.104	0.116
L6	15.25	15.75	0.600	0.620
L7	6.20	6.60	0.244	0.259
L9	3.50	3.93	0.137	0.154
M	2.6 typ.		0.102 typ.	
Diam. I	3.75	3.85	0.147	0.151

- COOLING METHOD : C
- RECOMMENDED TORQUE VALUE : 0.55 M.N
- MAXIMUM TORQUE VALUE : 0.70 M.N

Ordering type	Marking	Package	Weight	Base qty	Delivery mode
STPS15L25D	STPS15L25D	TO-220AC	1.86g	50	Tube
STPS15L25G	STPS15L25G	D ² PAK	1.48g	50	Tube
STPS15L25G-TR	STPS15L25G	D ² PAK	1.48g	1000	Tape & reel

- EPOXY MEETS UL94,V0

Information furnished is believed to be accurate and reliable. However, STMicroelectronics assumes no responsibility for the consequences of use of such information nor for any infringement of patents or other rights of third parties which may result from its use. No license is granted by implication or otherwise under any patent or patent rights of STMicroelectronics. Specifications mentioned in this publication are subject to change without notice. This publication supersedes and replaces all information previously supplied. STMicroelectronics products are not authorized for use as critical components in life support devices or systems without express written approval of STMicroelectronics.

The ST logo is a registered trademark of STMicroelectronics

© 2003 STMicroelectronics - Printed in Italy - All rights reserved.

STMicroelectronics GROUP OF COMPANIES

Australia - Brazil - Canada - China - Finland - France - Germany
 Hong Kong - India - Israel - Italy - Japan - Malaysia - Malta - Morocco - Singapore
 Spain - Sweden - Switzerland - United Kingdom - United States.

<http://www.st.com>



Mouser Electronics

Authorized Distributor

Click to View Pricing, Inventory, Delivery & Lifecycle Information:

[STMicroelectronics:](#)

[STPS15L25D](#)