

Single line low capacitance Transil™, transient surge voltage suppressor (TVS) for ESD protection

Datasheet - production data

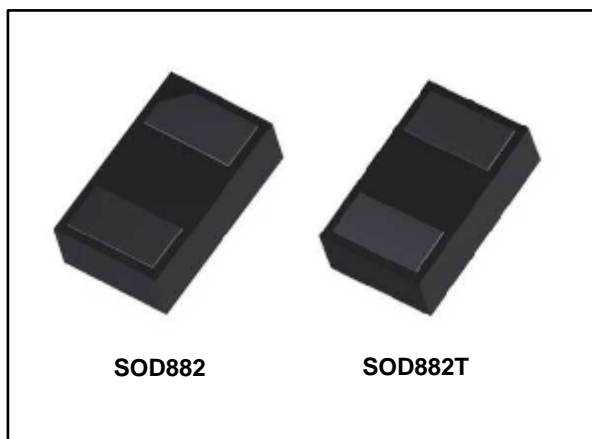

Complies with the following standards

- IEC 61000-4-2 (exceeds level 4)
 - 17 kV (air discharge)
 - 17 kV (contact discharge)
- MIL STD 883G - Method 3015-7: class 3
 - Human body model

Description

The ESDAVLC8-1BM2 (SOD882) and ESDAVLC8-1BT2 (SOD882T) are bidirectional single-line TVS diodes designed to protect data lines or other I/O ports against ESD transients.

These devices are ideal for applications where both printed circuit board space and power absorption capability are required.

Figure 1: Functional diagram

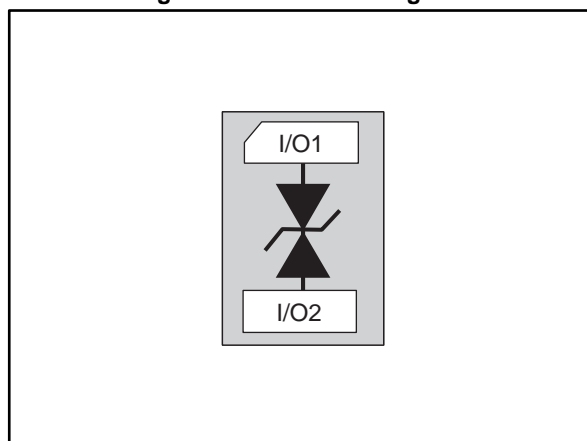

Features

- Single line bidirectional protection
- Breakdown voltage $V_{BR} = 8.5 \text{ V min.}$
- Very low capacitance = 4.5 pF at 0 V
- Lead-free packages
- ECOPACK®2 compliant packages

Applications

Where transient overvoltage protection in ESD sensitive equipment is required, such as:

- Computers
- Printers
- Communication systems
- Cellular phone handsets and accessories
- Video equipment

Benefits

- Very low capacitance for optimized data integrity
- Very low reverse current < 50 nA
- Low PCB space consumption: 0.6 mm² max.
- High reliability offered by monolithic integration

 TM: Transil is a trademark of STMicroelectronics

1 Characteristics

Table 1: Absolute maximum ratings ($T_{amb} = 25\text{ }^{\circ}\text{C}$)

Symbol	Parameter		Value	Unit
V_{PP}	Peak pulse voltage	IEC 61000-4-2: Contact discharge	17	kV
		Air discharge	17	
		MIL STD 883G - Method 3015-7: class 3	25	
P_{PP}	Peak pulse power	8/20 μ s, T_j initial = T_{amb}	30	W
I_{PP}	Peak pulse current	8/20 μ s	1.3	A
T_{OP}	Operating junction temperature range		-55 to +150	$^{\circ}\text{C}$
T_{stg}	Storage temperature range		-65 to +150	
T_L	Maximum lead temperature for soldering during 10 s		260	

Figure 2: Electrical characteristics (definitions)

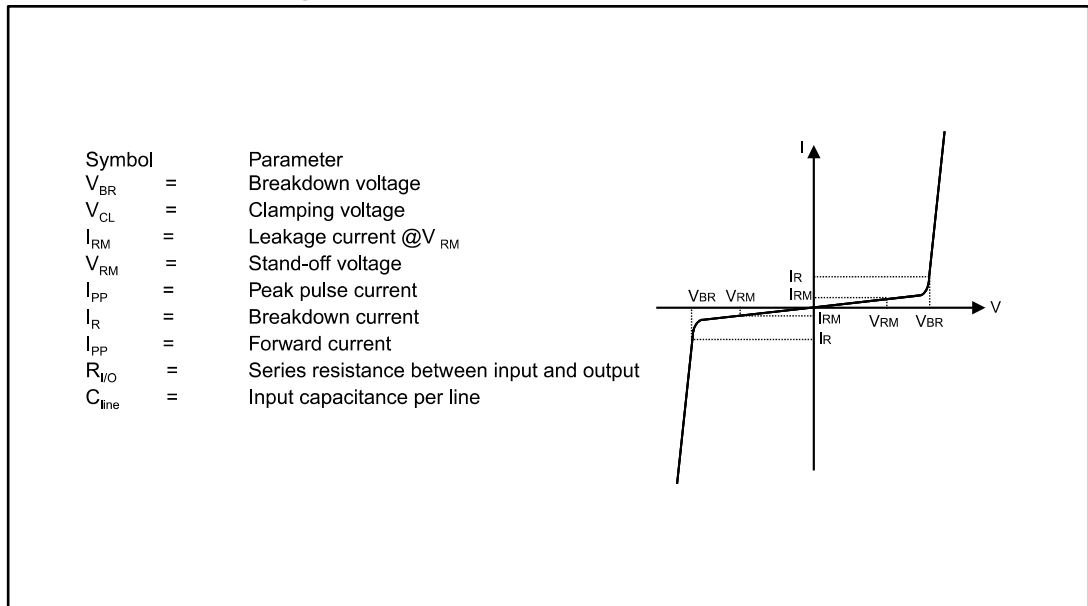
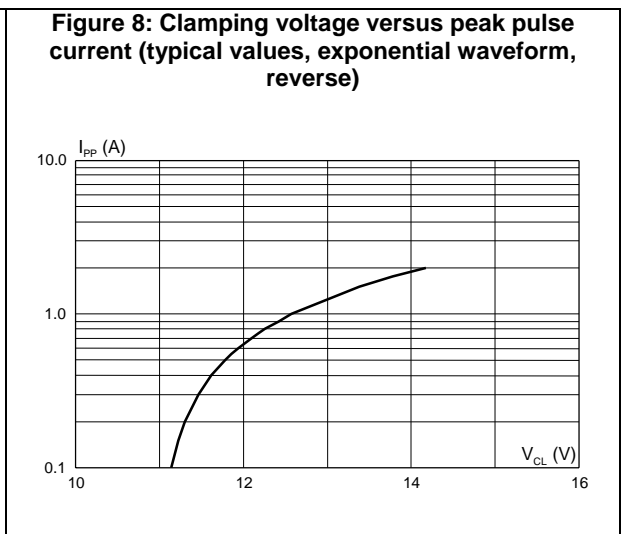
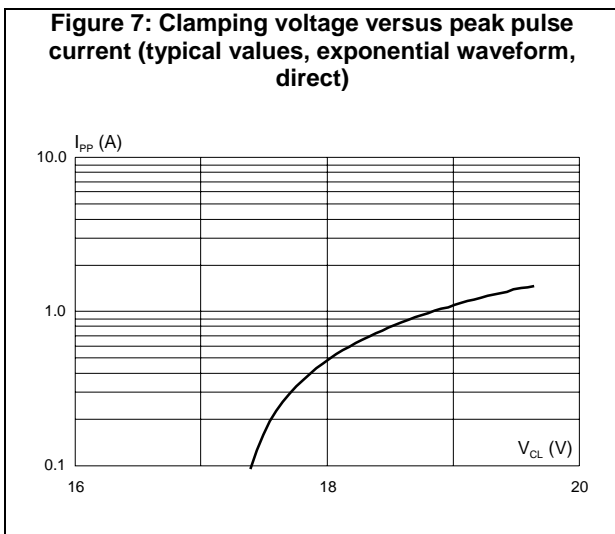
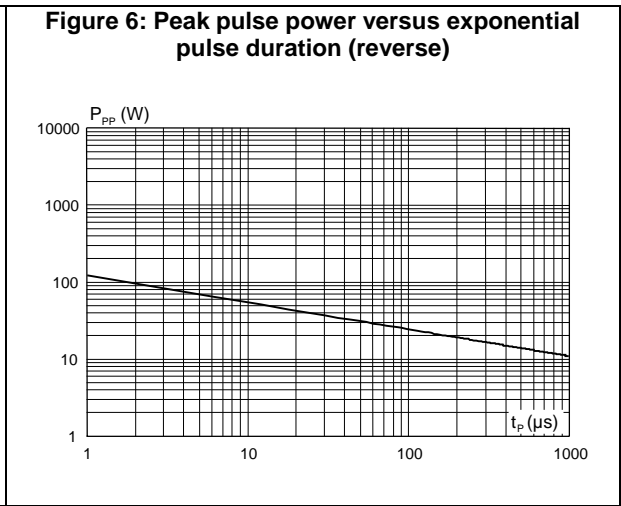
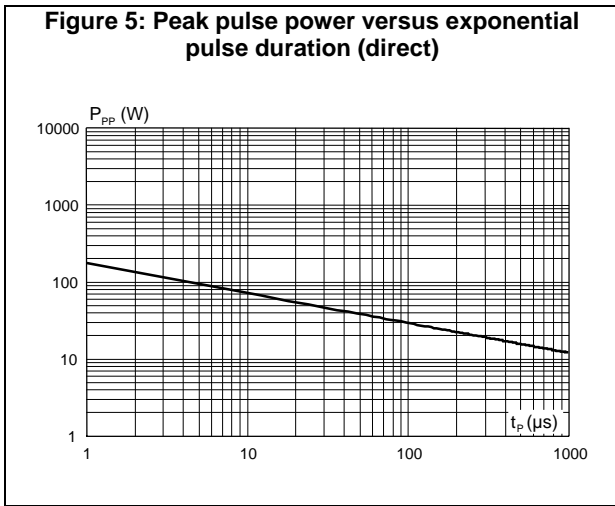
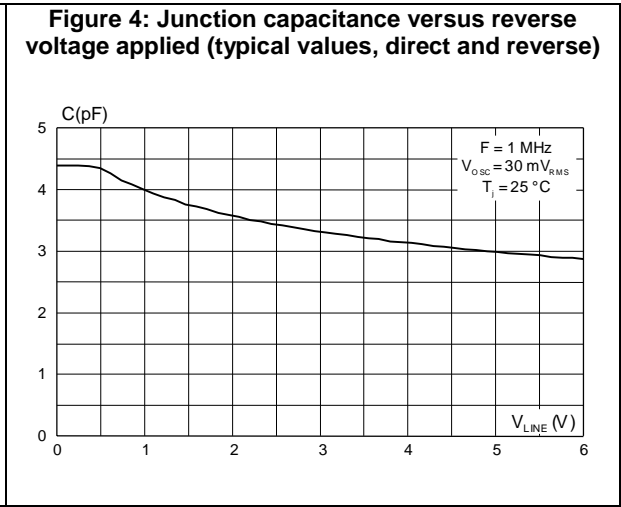
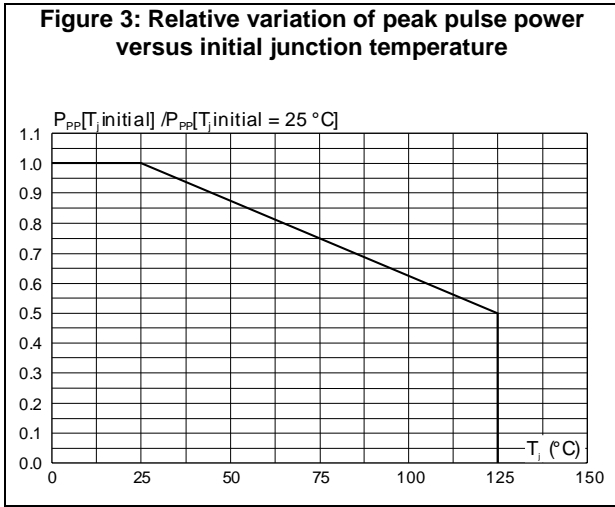

Table 2: Electrical characteristics ($T_{amb} = 25\text{ }^{\circ}\text{C}$)

Symbol	Test condition	Min.	Typ.	Max.	Unit
V_{BR}	From I/O1 to I/O2, $I_R = 1\text{ mA}$ direct	14.5	17		V
	From I/O2 to I/O1, $I_R = 1\text{ mA}$ reverse	8.5	11		
I_{RM}	$V_{RM} = 3\text{ V}$			50	nA
R_d	Square pulse, $I_{PP} = 1\text{ A}$, $t_p = 2.5\text{ }\mu\text{s}$		2		Ω
C_{line}	$F = 1\text{ MHz}$, $V_R = 0\text{ V}$		4.5	5.5	pF

Characteristics (curves)



Characteristics

ESDAVLC8-1BM2, ESDAVLC8-1BT2

Figure 9: Relative variation of leakage current versus junction temperature (direct)

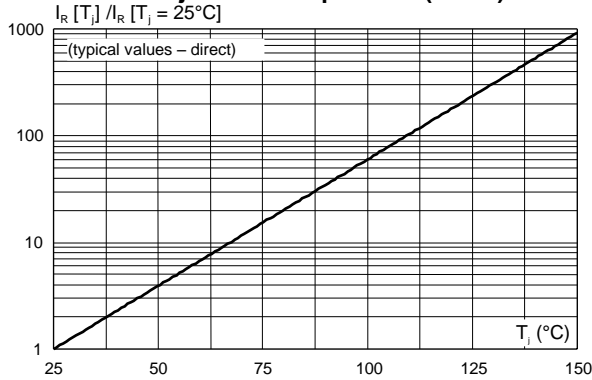

Figure 10: Relative variation of leakage current versus junction temperature (reverse)

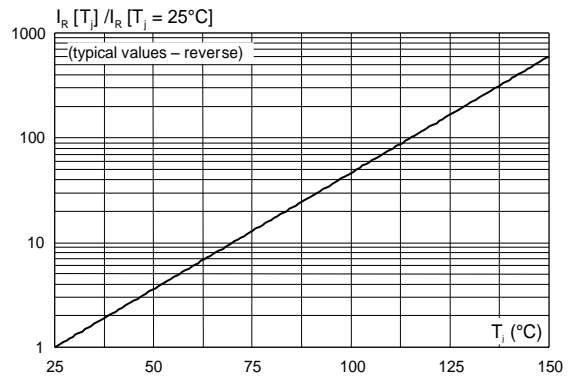

Figure 11: ESD response to IEC 61000-4-2 (+15 kV air discharge)

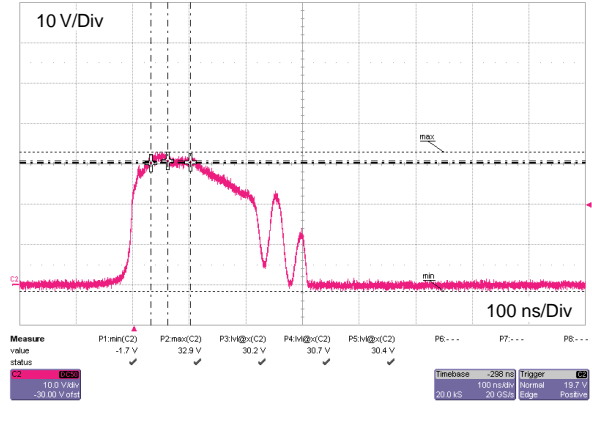

Figure 12: ESD response to IEC 61000-4-2 (-15 kV air discharge)

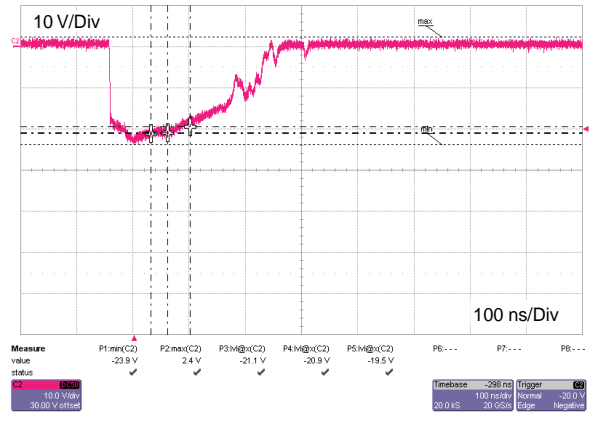

Figure 13: S21 attenuation measurement result

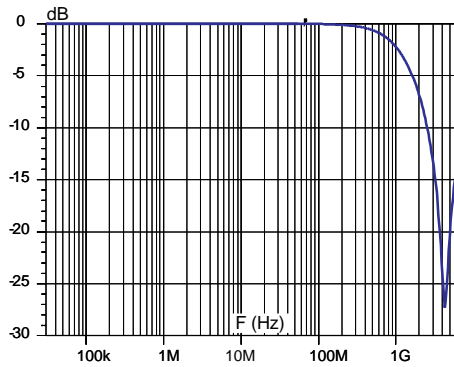
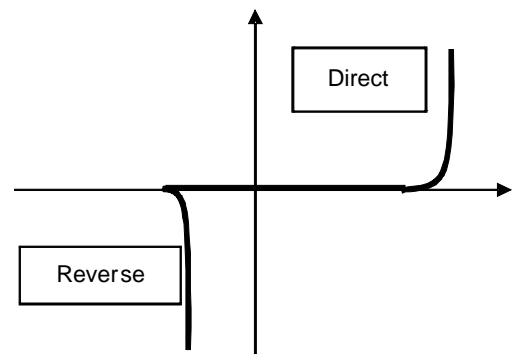

Figure 14: Static characteristic



2 Package information

In order to meet environmental requirements, ST offers these devices in different grades of ECOPACK® packages, depending on their level of environmental compliance. ECOPACK® specifications, grade definitions and product status are available at: www.st.com. ECOPACK® is an ST trademark.

2.1 SOD882 package information

Figure 15: SOD882 package outline

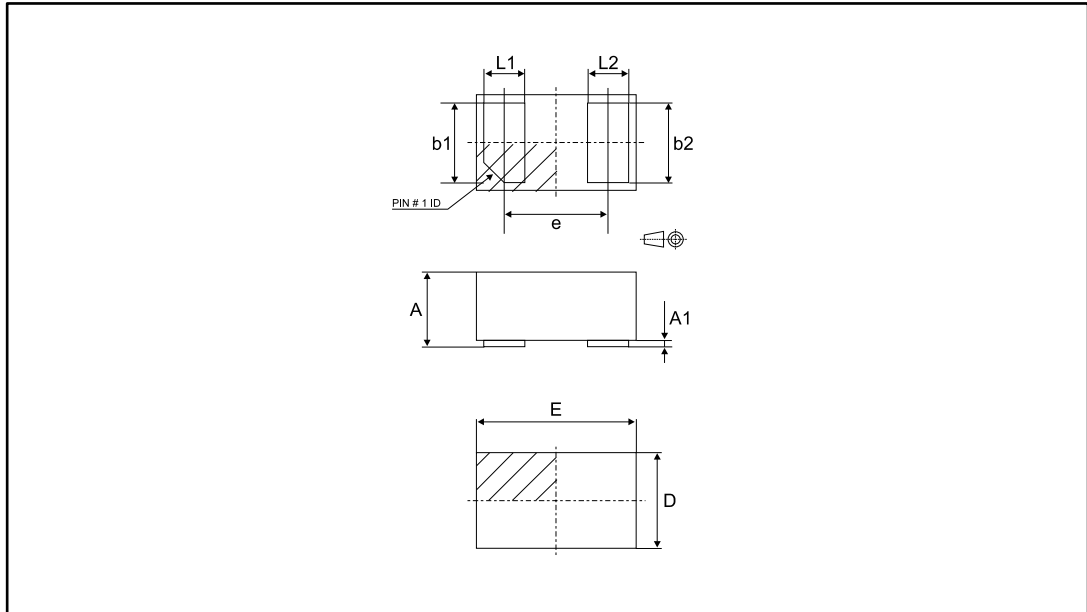
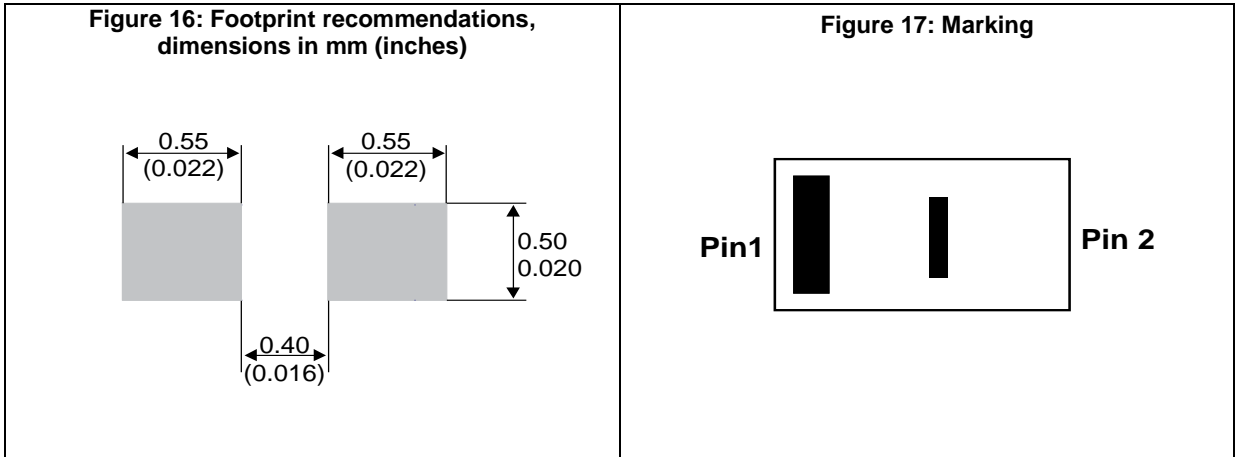

Table 3: SOD882 package mechanical data

Ref.	Dimensions					
	Millimeters			Inches		
	Min.	Typ.	Max.	Min.	Typ.	Max.
A	0.40	0.47	0.50	0.016	0.019	0.020
A1	0.00		0.05	0.000		0.002
b1	0.45	0.50	0.55	0.018	0.020	0.022
b2	0.45	0.50	0.55	0.018	0.020	0.022
D	0.55	0.60	0.65	0.022	0.024	0.026
E	0.95	1.00	1.05	0.037	0.039	0.041
e	0.60	0.65	0.70	0.024	0.026	0.028
L1	0.20	0.25	0.30	0.008	0.010	0.012
L2	0.20	0.25	0.30	0.008	0.010	0.012



Product marking may be rotated by multiples of 90° for assembly plant differentiation. In no case should this product marking be used to orient the component for its placement on a PCB. Only pin 1 mark is to be used for this purpose.

Figure 18: SOD882 tape and specifications

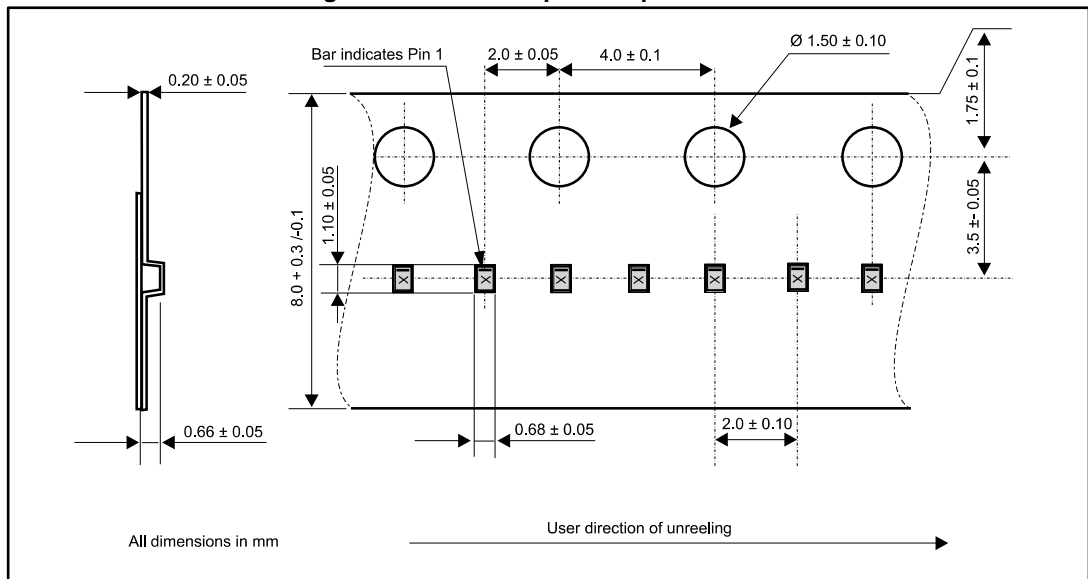

2.2 SOD882T package information

Figure 19: SOD882T package outline

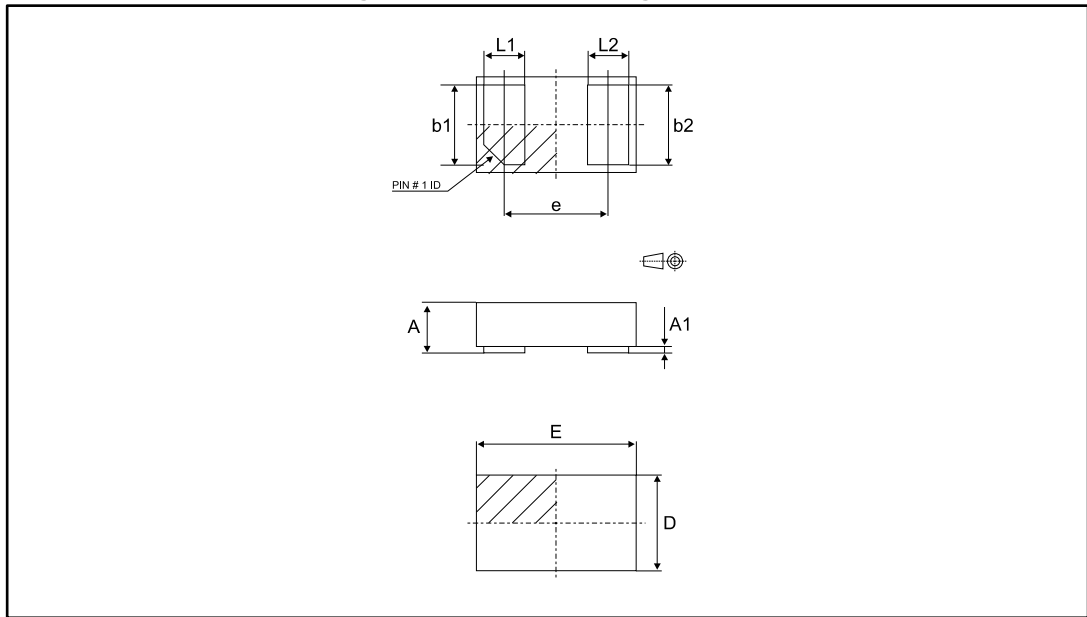
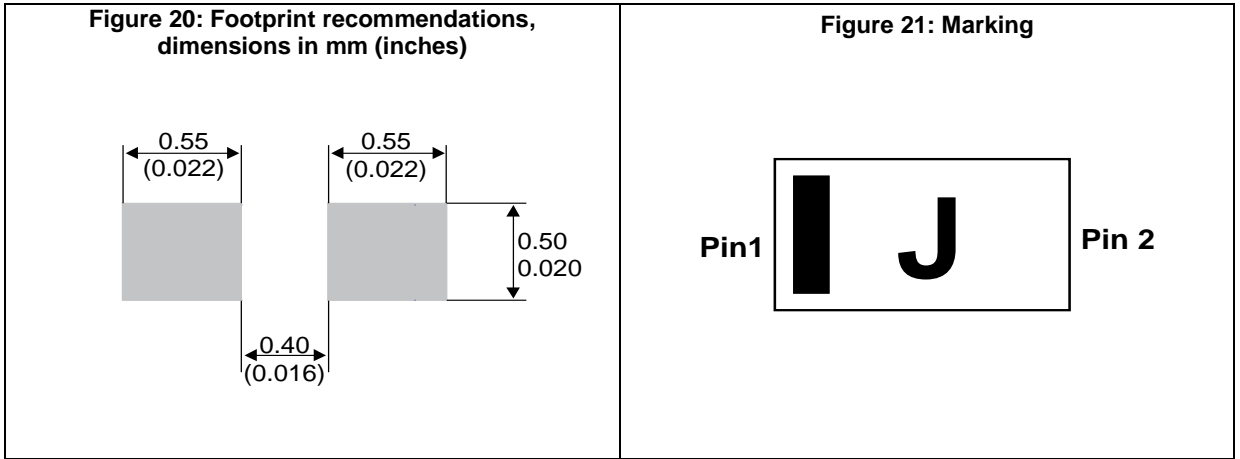

Table 4: SOD882T package mechanical data

Ref.	Dimensions					
	Millimeters			Inches		
	Min.	Typ.	Max.	Min.	Typ.	Max.
A	0.30		0.40	0.012		0.016
A1	0.00		0.05	0.000		0.002
b1	0.45	0.50	0.55	0.018	0.020	0.022
b2	0.45	0.50	0.55	0.018	0.020	0.022
D	0.55	0.60	0.65	0.022	0.024	0.026
E	0.95	1.00	1.05	0.037	0.039	0.041
e	0.60	0.65	0.70	0.024	0.026	0.028
L1	0.20	0.25	0.30	0.008	0.010	0.012
L2	0.20	0.25	0.30	0.008	0.010	0.012



Product marking may be rotated by multiples of 90° for assembly plant differentiation. In no case should this product marking be used to orient the component for its placement on a PCB. Only pin 1 mark is to be used for this purpose.

Figure 22: SOD882T tape and specifications

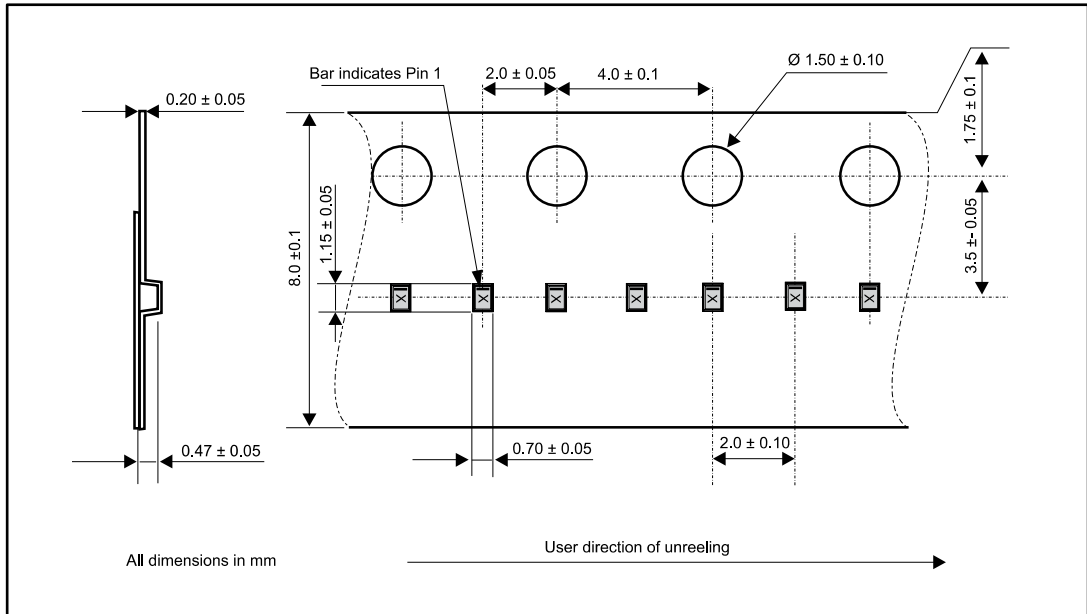

3 Recommendation on PCB assembly

3.1 Stencil opening design

1. General recommendation on stencil opening design
 - a. Stencil opening dimensions: L (Length), W (Width), T (Thickness).
2. General design rule
 - a. Stencil thickness (T) = 75 ~ 125 μm
 - b. Aspect ratio = $\frac{W}{T} \geq 1.5$
 - c. Aspect area = $\frac{L \times W}{2T(L+W)} \geq 0.66$
3. Reference design
 - a. Stencil opening thickness: 100 μm
 - b. Stencil opening for central exposed pad: Opening to footprint ratio is 50%.
 - c. Stencil opening for leads: Opening to footprint ratio is 90%.

Figure 23: Stencil opening dimensions

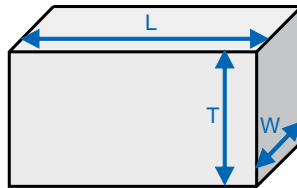
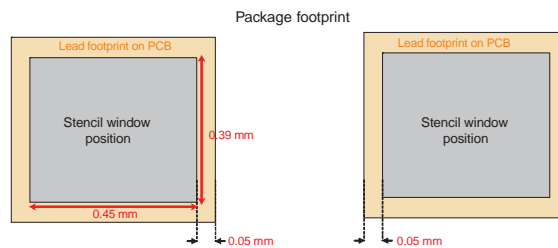

Figure 24: Recommended stencil window position in mm (inches)



3.2 Solder paste

1. Halide-free flux qualification ROL0 according to ANSI/J-STD-004.
2. "No clean" solder paste is recommended.
3. Offers a high tack force to resist component movement during high speed.
4. Solder paste with fine particles: powder particle size is 20-45 μm .

3.3 Placement

1. Manual positioning is not recommended.
2. It is recommended to use the lead recognition capabilities of the placement system, not the outline centering
3. Standard tolerance of ± 0.05 mm is recommended.
4. 3.5 N placement force is recommended. Too much placement force can lead to squeezed out solder paste and cause solder joints to short. Too low placement force can lead to insufficient contact between package and solder paste that could cause open solder joints or badly centered packages.
5. To improve the package placement accuracy, a bottom side optical control should be performed with a high resolution tool.
6. For assembly, a perfect supporting of the PCB (all the more on flexible PCB) is recommended during solder paste printing, pick and place and reflow soldering by using optimized tools.

3.4 PCB design preference

1. To control the solder paste amount, the closed via is recommended instead of open vias.
2. The position of tracks and open vias in the solder area should be well balanced. The symmetrical layout is recommended, in case any tilt phenomena caused by asymmetrical solder paste amount due to the solder flow away.

3.5 Reflow profile

Figure 25: ST ECOPACK® recommended soldering reflow profile for PCB mounting

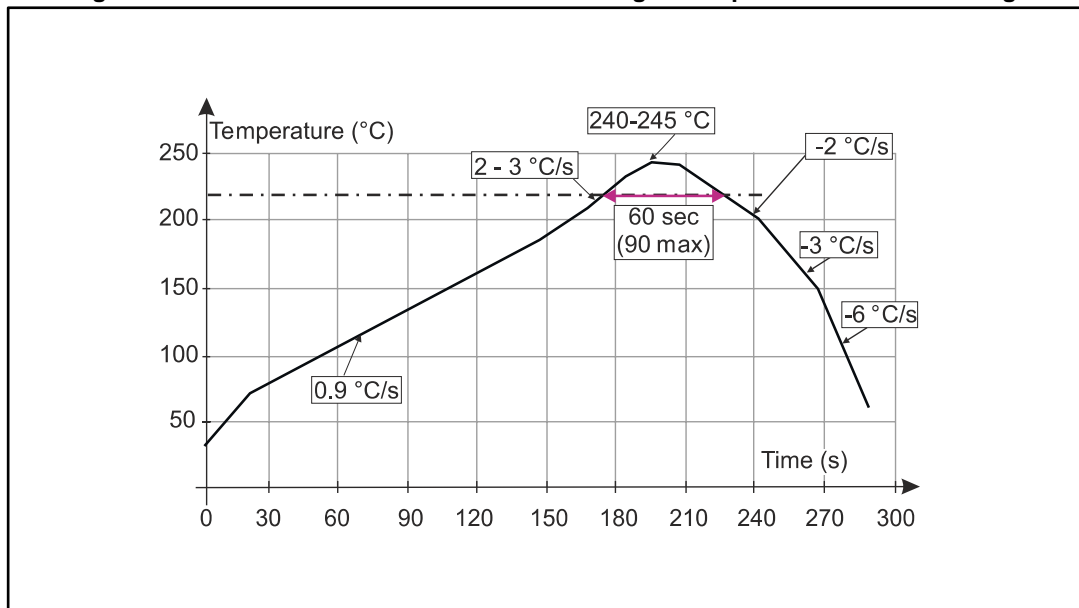

Minimize air convection currents in the reflow oven to avoid component movement.



Maximum soldering profile corresponds to the latest IPC/JEDEC J-STD-020.

4 Ordering information

Figure 26: Ordering information scheme

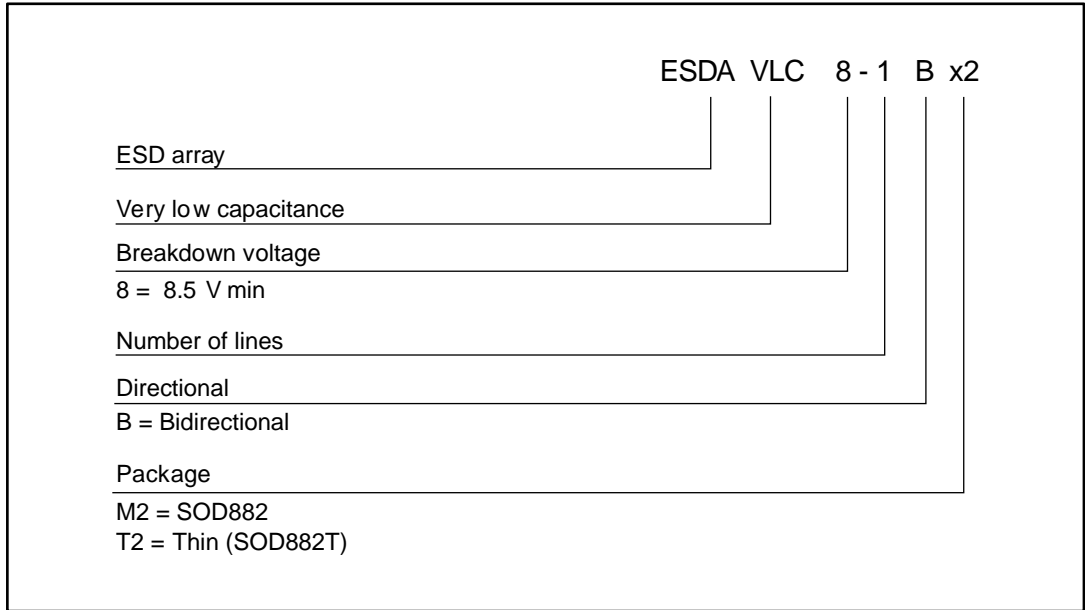

Table 5: Ordering information

Order code	Marking ⁽¹⁾	Package	Weight	Base qty.	Delivery mode
ESDAVLC8-1BM2	I	SOD882	0.92 mg	12000	Tape and reel
ESDAVLC8-1BT2	J	SOD882T	0.76 mg	12000	Tape and reel

Notes:

⁽¹⁾The marking can be rotated by multiples of 90° to differentiate assembly location

5 Revision history

Table 6: Document revision history

Date	Revision	Changes
22-Jan-2010	1	Initial release.
08-Jun-2012	2	Updated <i>Figure 11</i> , <i>Figure 12</i> , <i>Figure 16</i> , <i>Figure 19</i> , <i>Figure 20</i> , and added <i>Figure 23</i> . Updated <i>Table 3</i> and <i>Table 4</i> . Updated note on page 7, 8 and 13..
18-Nov-2016	3	Cover image updated.

IMPORTANT NOTICE – PLEASE READ CAREFULLY

STMicroelectronics NV and its subsidiaries ("ST") reserve the right to make changes, corrections, enhancements, modifications, and improvements to ST products and/or to this document at any time without notice. Purchasers should obtain the latest relevant information on ST products before placing orders. ST products are sold pursuant to ST's terms and conditions of sale in place at the time of order acknowledgement.

Purchasers are solely responsible for the choice, selection, and use of ST products and ST assumes no liability for application assistance or the design of Purchasers' products.

No license, express or implied, to any intellectual property right is granted by ST herein.

Resale of ST products with provisions different from the information set forth herein shall void any warranty granted by ST for such product.

ST and the ST logo are trademarks of ST. All other product or service names are the property of their respective owners.

Information in this document supersedes and replaces information previously supplied in any prior versions of this document.

© 2016 STMicroelectronics – All rights reserved

Mouser Electronics

Authorized Distributor

Click to View Pricing, Inventory, Delivery & Lifecycle Information:

[STMicroelectronics:](#)

[ESDAVLC8-1BM2](#) [ESDAVLC8-1BT2](#)