

DS9490R/DS9490B USB to 1-Wire/iButton Adapters

FEATURES

- High-Speed 12Mbps Universal Serial Bus (USB) Interface
- Supports Standard and Overdrive 1-Wire® Communication
- Slew-Rate-Controlled 1-Wire Timing and Active Pullup for Improved 1-Wire Network Performance
- DS9490R has an RJ11 Interface for Standard Connectivity Accessories such as the DS1402D-DR8
- DS9490B has an iButton® Interface and Retains a Fixed iButton
- Built-In Custom DS2401 Identification Chip
- Reads all 1-Wire and iButton Devices. Writes All Except EPROM 1-Wire/iButton Devices

APPLICATIONS

- Software Authorization—Protection against software piracy by tying software operation to the presence of iButton hardware.
- iButton Initialization and Download—Loggers like the ThermoChron® can be missioned and downloaded.
- Demonstration—Demonstrate the features of iButtons or 1-Wire chips on personal computers.
- Development—Aid development of 1-Wire applications by providing a PC interface to verify device contents and state.

DESCRIPTION

The DS9490B is a USB bridge and holder for a single F5-size iButton. The iButton is securely held behind a latched door. The DS9490R is a USB bridge with 1-Wire RJ11 interface to accommodate 1-Wire receptacles and networks. For a list of suitable 1-Wire network cables, refer to the *Connectivity Matrix* table in the DS1402x 1-Wire network cables data sheet. Both adapters are based on the DS2490 USB-to-1-Wire bridge chip. Free software drivers for Windows®-based PCs can be downloaded from www.maxim-ic.com/1-Wiredrivers.

1-Wire, iButton, and ThermoChron are registered trademarks of Maxim Integrated Products, Inc.
Windows is a registered trademark of Microsoft Corp.

TYPICAL OPERATING CIRCUIT

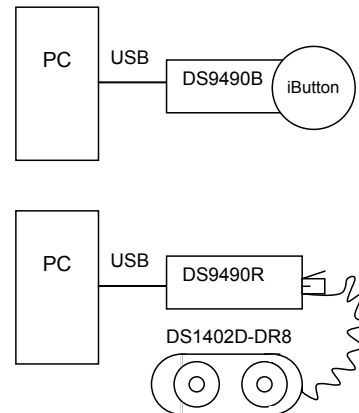

ORDERING INFORMATION

PART	TYPE
DS9490B#	USB Single F5 iButton Holder with Protective Cap
DS9490R#	USB-to-1-Wire RJ11

#Denotes a RoHS-compliant device that may include lead(Pb) that is exempt under the RoHS requirements.

PACKAGING/SHIPPING INFORMATION

The part is shipped individually in an antistatic bag.

Figure 1. DS9490R



Figure 2. DS9490B



***Note:** To eject an iButton, insert a straightened paper clip into the side access hole of the DS9490B. Push the paper clip in the direction of the iButton. A different iButton can then be inserted. The data contact faces down and away from the embossed ‘i’. Before inserting the paper clip disconnect the DS9490B from the USB bus.

Each USB bridge contains a unique built-in identification chip. The identification chip is a custom DS2401 that is a 64-bit ID number (see Figure 3).

Figure 3. DS2401 ID CHIP 64-BIT LASERED ROM

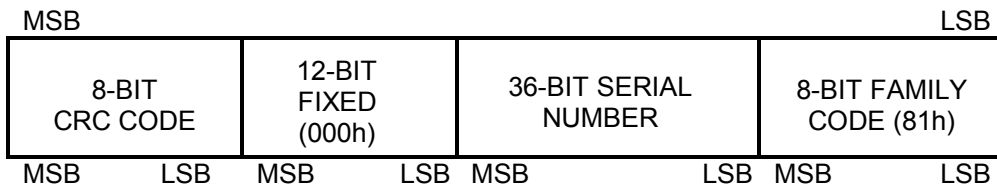

DS9490R/DS9490B

PIN CONFIGURATION

Figure 4. 1-Wire RJ11 SOCKET FOR DS9490R

PIN	SIGNAL NAME	DESCRIPTION
1	V _{DD}	5VDC Output
2	GND	Power Ground
3	OW	1-Wire Data
4	GND_OW	1-Wire Return
5	SUS \bar{O}	USB Suspend Output
6	N.C.	No Connection

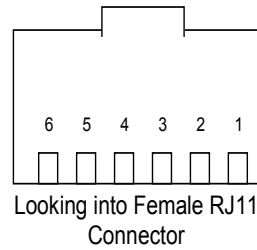
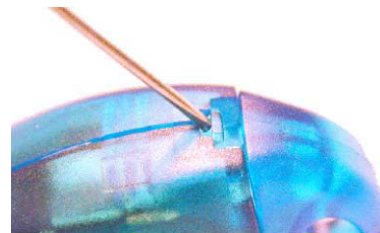
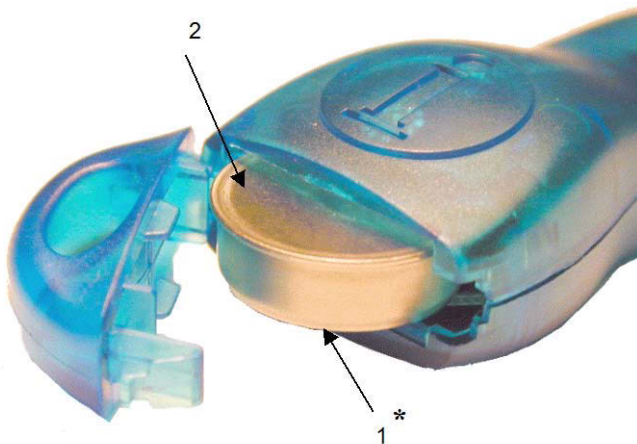

Figure 5. iButton SOCKET FOR DS9490B

PIN	SIGNAL NAME	DESCRIPTION
1	OW	1-Wire Data
2	GND_OW	1-Wire Return



***Note:** The data contact faces down and away from the embossed ‘i’. Once the iButton is inserted in the enclosure, snap the end cap over it. The end cap is removed by depressing the release tab with a paper clip, swinging it fully open, and sliding out the hinge.

MECHANICAL DIMENSIONS

All dimensions are in millimeters.

Figure 6. DS9490R

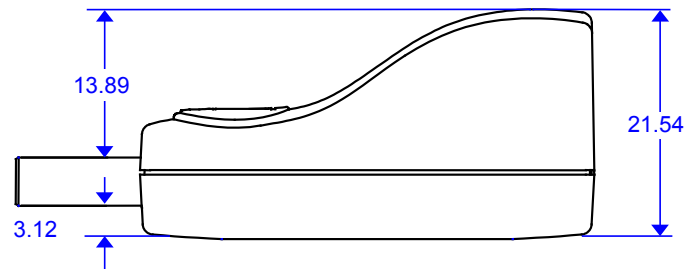
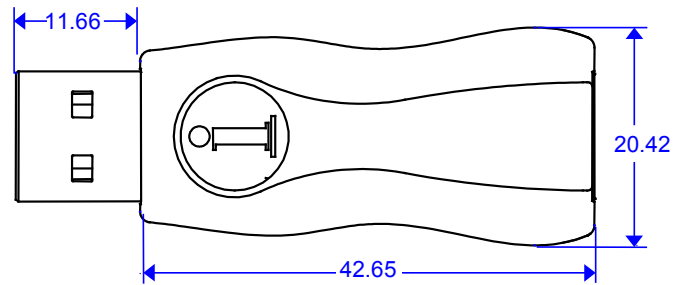
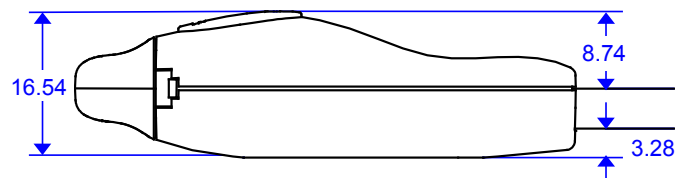
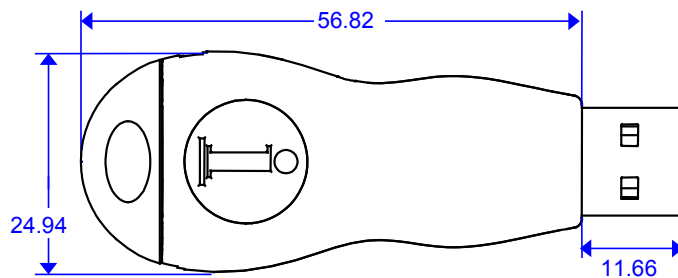

Figure 7. DS9490B



ENVIRONMENTAL REQUIREMENTS

CONDITION	PARAMETER	VALUE
Storage	Temperature	-10°C to +85°C
Storage	Relative humidity, noncondensing	95%
Storage	Duration	1yr (max) at 95%RH and +85°C
Operating	Temperature	0°C to +70°C
Operating	Relative humidity, noncondensing	80%

REVISION HISTORY

REVISION DATE	DESCRIPTION	PAGES CHANGED
5/03	Initial release	—
1/07	Added RoHS-compliant part numbers to the <i>Ordering Information</i> table; replaced product graphics with product photos; changed schematic and Figure 4 to route the $\overline{\text{SUSO}}$ signal to RJ11 pin 5; reworded the text in the <i>Electrical Characteristics</i> section to include the $\overline{\text{SUSO}}$ pin and its use	1, 2, 3, 5
8/09	Removed references to leaded packages in the <i>Ordering Information</i> table; added the <i>Revision History</i> table	1, 6
6/11	Deleted reference to monetary $\overline{\text{iButtons}}$; added reference to the <i>Connectivity Matrix</i> table in the DS1402x 1-Wire network cables data sheet; revised description and URL for software drivers download	1



Maxim cannot assume responsibility for use of any circuitry other than circuitry entirely embodied in a Maxim product. No circuit patent licenses are implied. Maxim reserves the right to change the circuitry and specifications without notice at any time. The parametric values (min and max limits) shown in the Electrical Characteristics table are guaranteed. Other parametric values quoted in this data sheet are provided for guidance.

Maxim Integrated 160 Rio Robles, San Jose, CA 95134 USA 1-408-601-1000

6

Mouser Electronics

Authorized Distributor

Click to View Pricing, Inventory, Delivery & Lifecycle Information:

[Maxim Integrated:](#)

[DS9490B#](#) [DS9490R#](#)