

ISL28118M

40V Extended Temperature Range, Precision Single-Supply, Rail-to-Rail Output, Operational Amplifier

FN7858  
Rev 1.00  
March 7, 2014

The ISL28118M is a single, low-power precision amplifier optimized for single-supply applications over the extended temperature range of -55 °C to +125 °C. This device features a common mode input voltage range extending to 0.5V below the V- rail, a rail-to-rail differential input voltage range for use as a comparator, and rail-to-rail output voltage swing, which makes it ideal for single-supply applications where input operation at ground is important.

The ISL28118M features low power, low offset voltage, and low temperature drift, making it the ideal choice for applications requiring both high DC accuracy and AC performance. The op amp is designed to operate over a single supply range of 3V to 40V or a split supply voltage range of +1.8V/-1.2V to ±20V. The combination of precision and small footprint provides the user with outstanding value and flexibility relative to similar competitive parts.

Applications include precision instrumentation, data acquisition, precision power supply controls, and industrial controls.

The ISL28118M is offered in the 8 Ld MSOP package and operate over the extended temperature range of -55 °C to +125 °C.

Features

- Rail-to-rail output ..... <10mV
- Below-ground (V-) input capability to -0.5V
- Rail-to-rail input differential voltage range for comparator applications
- Single-supply range ..... 3V to 40V
- Low current consumption ..... 850µA
- Low noise voltage ..... 5.6nV/√Hz
- Low noise current ..... 355fA/√Hz
- Low input offset voltage ..... 150µV Max.
- Superb offset voltage temperature drift. . . . 1.2µV/°C, Max.
- Operating temperature range. . . . .-55°C to +125°C
- No phase reversal

Applications

- Precision instruments
- Medical instrumentation
- Data acquisition
- Power supply control
- Industrial process control

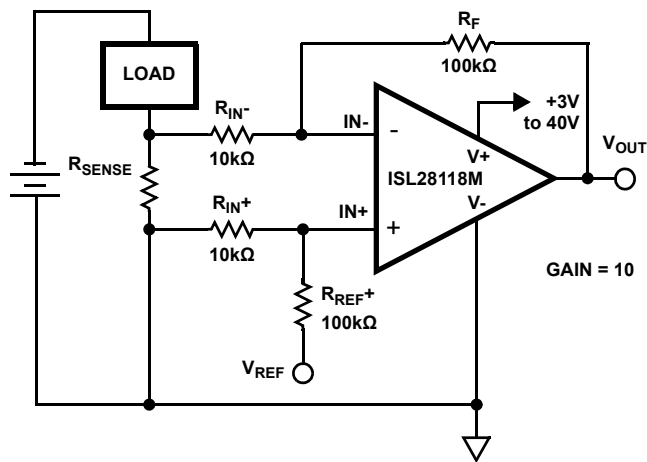

FIGURE 1. TYPICAL APPLICATION: SINGLE-SUPPLY, LOW-SIDE CURRENT SENSE AMPLIFIER

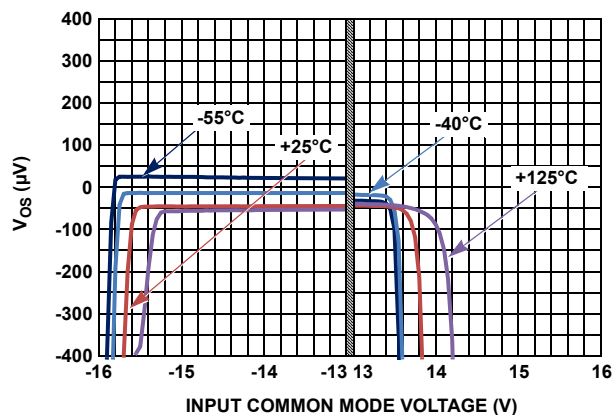

FIGURE 2. INPUT OFFSET VOLTAGE vs INPUT COMMON MODE VOLTAGE, -40°C to +125°C, V<sub>S</sub> = ±15V

---

## Table of Contents

<b>Pin Configurations</b> .....	<b>3</b>
<b>Pin Descriptions</b> .....	<b>3</b>
<b>Ordering Information</b> .....	<b>3</b>
<b>Absolute Maximum Ratings</b> .....	<b>4</b>
<b>Thermal Information</b> .....	<b>4</b>
<b>Operating Conditions</b> .....	<b>4</b>
<b>Electrical Specifications, <math>V_S \pm 15</math></b> .....	<b>4</b>
<b>Electrical Specifications, <math>V_S \pm 5V</math></b> .....	<b>5</b>
<b>Typical Performance Curves</b> .....	<b>7</b>
<b>Applications Information</b> .....	<b>15</b>
Functional Description .....	15
Operating Voltage Range .....	15
Input Stage Performance .....	15
Output Drive Capability .....	15
Output Phase Reversal .....	15
Power Dissipation .....	15
ISL28118M SPICE Model .....	16
<b>Characterization vs Simulation Results</b> .....	<b>19</b>
<b>Revision History</b> .....	<b>22</b>
<b>About Intersil</b> .....	<b>22</b>
<b>Package Outline Drawing</b> .....	<b>23</b>

## Pin Configurations

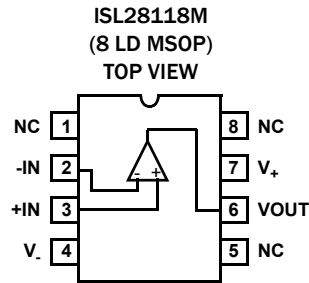

## Pin Descriptions

ISL28118M (8 LD MSOP)	PIN NAME	EQUIVALENT CIRCUIT	DESCRIPTION
3	+IN	1	Amplifier A non-inverting input
2	-IN	1	Amplifier A inverting input
6	VOUT	2	Amplifier A output
4	V <sub>-</sub>	3	Negative power supply
7	V <sub>+</sub>	3	Positive power supply
1, 5, 8	NC	-	No Connect

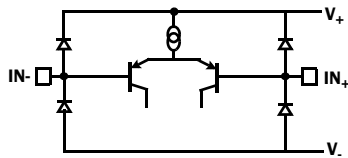

CIRCUIT 1

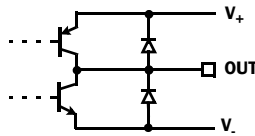

CIRCUIT 2

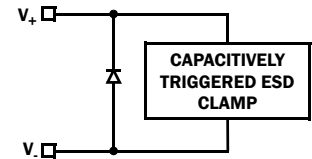

CIRCUIT 3

## Ordering Information

PART NUMBER (Notes 1, 2, 3)	PART MARKING	TEMP RANGE (°C)	PACKAGE (Pb-Free)	PKG. DWG. #
ISL28118MUZ	8118M	-55 to +125	8 Ld MSOP	M8.118B

NOTES:

1. Add "-T\*" suffix for tape and reel. Please refer to [TB347](#) for details on reel specifications.
2. These Intersil Pb-free plastic packaged products employ special Pb-free material sets, molding compounds/die attach materials, and 100% matte tin plate plus anneal (e3 termination finish, which is RoHS compliant and compatible with both SnPb and Pb-free soldering operations). Intersil Pb-free products are MSL classified at Pb-free peak reflow temperatures that meet or exceed the Pb-free requirements of IPC/JEDEC J STD-020.
3. For Moisture Sensitivity Level (MSL), please see product information page for [ISL28118M](#). For more information on MSL, please see tech brief [TB363](#).

## Absolute Maximum Ratings

Maximum Supply Voltage	42V
Maximum Differential Input Current	20mA
Maximum Differential Input Voltage	.42V or $V_- - 0.5V$ to $V_+ + 0.5V$
Min/Max Input Voltage	.42V or $V_- - 0.5V$ to $V_+ + 0.5V$
Max/Min Input Current	$\pm 20mA$
Output Short-Circuit Duration (1 output at a time)	Indefinite
ESD Tolerance	
Human Body Model (Tested per JESD22-A114F)	3kV
Machine Model (Tested per JESD22-A115-A)	300V
Charged Device Model (Tested per CDM-22C10ID)	2kV

## Thermal Information

Thermal Resistance (Typical)	$\theta_{JA}$ ( $^{\circ}C/W$ )	$\theta_{JC}$ ( $^{\circ}C/W$ )
8 Ld MSOP Package (Notes 4, 5)	165	57
Storage Temperature Range	-65 $^{\circ}C$ to +150 $^{\circ}C$	
Pb-free Reflow Profile	see link below <a href="http://www.intersil.com/pbfree/Pb-FreeReflow.asp">http://www.intersil.com/pbfree/Pb-FreeReflow.asp</a>	

## Operating Conditions

Ambient Operating Temperature Range	-55 $^{\circ}C$ to +125 $^{\circ}C$
Maximum Operating Junction Temperature	+150 $^{\circ}C$
Supply Voltage	3V (+1.8V/-1.2V) to 40V ( $\pm 20V$ )

**CAUTION:** Do not operate at or near the maximum ratings listed for extended periods of time. Exposure to such conditions may adversely impact product reliability and result in failures not covered by warranty.

### NOTES:

- $\theta_{JA}$  is measured with the component mounted on a high effective thermal conductivity test board in free air. See Tech Brief [TB379](#) for details.
- For  $\theta_{JC}$ , the "case temp" location is taken at the package top center.

**Electrical Specifications,  $V_S \pm 15$**   $V_{CM} = 0$ ,  $V_O = 0V$ ,  $R_L = \text{Open}$ ,  $T_A = +25^{\circ}C$ , unless otherwise noted. **Boldface limits apply across the operating temperature range, -55 $^{\circ}C$  to +125 $^{\circ}C$ . Temperature data established by characterization.**

PARAMETER	DESCRIPTION	CONDITIONS	MIN (Note 6)	TYP	MAX (Note 6)	UNIT
$V_{OS}$	Input Offset Voltage		-150	25	150	$\mu V$
			<b>-270</b>		<b>270</b>	$\mu V$
$TCV_{OS}$	Input Offset Voltage Temperature Coefficient		<b>-1.2</b>	<b>0.2</b>	<b>1.2</b>	$\mu V/^{\circ}C$
$I_B$	Input Bias Current		-575	-230		nA
			<b>-800</b>			nA
$TCI_B$	Input Bias Current Temperature Coefficient			<b>-0.8</b>		nA/ $^{\circ}C$
$I_{OS}$	Input Offset Current		-50	4	50	nA
			<b>-75</b>		<b>75</b>	nA
CMRR	Common-Mode Rejection Ratio	$V_{CM} = V_- - 0.5V$ to $V_+ - 1.8V$		118		dB
		$V_{CM} = V_-$ to $V_+ - 1.8V$	102	118		dB
			<b>97</b>			dB
$V_{CMIR}$	Common Mode Input Voltage Range	Guaranteed by CMRR test	$V_- - 0.5$		$V_+ - 1.8$	V
			<b><math>V_-</math></b>		<b><math>V_+ - 1.8</math></b>	V
PSRR	Power Supply Rejection Ratio	$V_S = 3V$ to 40V, $V_{CMIR} = \text{Valid Input Voltage}$	109	124		dB
			<b>105</b>			dB
$A_{VOL}$	Open-Loop Gain	$V_O = -13V$ to +13V, $R_L = 10k\Omega$ to ground	120	136		dB
			<b>114</b>			dB
$V_{OL}$	Output Voltage Low, $V_{OUT}$ to $V_-$	$R_L = 10k\Omega$			70	mV
					<b>85</b>	mV
$V_{OH}$	Output Voltage High, $V_+$ to $V_{OUT}$	$R_L = 10k\Omega$			110	mV
					<b>120</b>	mV
$I_S$	Supply Current/Amplifier	$R_L = \text{Open}$		0.85	1.2	mA
					<b>1.6</b>	mA
$I_{SC+}$	Output Short Circuit Source Current	$R_L = 10\Omega$ to $V_-$		16		mA

**Electrical Specifications,  $V_S \pm 15$**   $V_{CM} = 0$ ,  $V_O = 0V$ ,  $R_L = \text{Open}$ ,  $T_A = +25^\circ\text{C}$ , unless otherwise noted. **Boldface limits apply across the operating temperature range,  $-55^\circ\text{C}$  to  $+125^\circ\text{C}$ . Temperature data established by characterization. (Continued)**

PARAMETER	DESCRIPTION	CONDITIONS	MIN (Note 6)	TYP	MAX (Note 6)	UNIT
$I_{SC}$	Output Short Circuit Sink Current	$R_L = 10\Omega$ to $V_+$		28		mA
$V_{SUPPLY}$	Supply Voltage Range	Guaranteed by PSRR	<b>3</b>		<b>40</b>	V
<b>AC SPECIFICATIONS</b>						
GBWP	Gain Bandwidth Product	$A_{CL} = 101$ , $V_{OUT} = 100\text{mV}_{P-P}$ ; $R_L = 2k$		4		MHz
$e_{np-p}$	Voltage Noise	0.1Hz to 10Hz, $V_S = \pm 18V$		300		$\text{nV}_{P-P}$
$e_n$	Voltage Noise Density	$f = 10\text{Hz}$ , $V_S = \pm 18V$		8.5		$\text{nV}/\sqrt{\text{Hz}}$
$e_n$	Voltage Noise Density	$f = 100\text{Hz}$ , $V_S = \pm 18V$		5.8		$\text{nV}/\sqrt{\text{Hz}}$
$e_n$	Voltage Noise Density	$f = 1\text{kHz}$ , $V_S = \pm 18V$		5.6		$\text{nV}/\sqrt{\text{Hz}}$
$e_n$	Voltage Noise Density	$f = 10\text{kHz}$ , $V_S = \pm 18V$		5.6		$\text{nV}/\sqrt{\text{Hz}}$
$i_n$	Current Noise Density	$f = 1\text{kHz}$ , $V_S = \pm 18V$		355		$\text{fA}/\sqrt{\text{Hz}}$
THD + N	Total Harmonic Distortion + Noise	1kHz, $G = 1$ , $V_O = 3.5V_{RMS}$ , $R_L = 10k\Omega$		0.0003		%
<b>TRANSIENT RESPONSE</b>						
SR	Slew Rate	$A_V = 1$ , $R_L = 2k\Omega$ , $V_O = 10V_{P-P}$		$\pm 1.2$		$\text{V}/\mu\text{s}$
$t_r$ , $t_f$ , Small Signal	Rise Time 10% to 90% of $V_{OUT}$	$A_V = 1$ , $V_{OUT} = 100\text{mV}_{P-P}$ , $R_f = 0\Omega$ , $R_L = 2k\Omega$ to $V_{CM}$		100		ns
	Fall Time 90% to 10% of $V_{OUT}$	$A_V = 1$ , $V_{OUT} = 100\text{mV}_{P-P}$ , $R_f = 0\Omega$ , $R_L = 2k\Omega$ to $V_{CM}$		100		ns
$t_s$	Settling Time to 0.01% 10V Step; 10% to $V_{OUT}$	$A_V = 1$ , $V_{OUT} = 10V_{P-P}$ , $R_f = 0\Omega$ , $R_L = 2k\Omega$ to $V_{CM}$		8.5		$\mu\text{s}$

**Electrical Specifications,  $V_S \pm 5V$**   $V_{CM} = 0$ ,  $V_O = 0V$ ,  $T_A = +25^\circ\text{C}$ , unless otherwise noted. **Boldface limits apply over the operating temperature range,  $-55^\circ\text{C}$  to  $+125^\circ\text{C}$ . Temperature data established by characterization.**

PARAMETER	DESCRIPTION	CONDITIONS	MIN (Note 6)	TYP	MAX (Note 6)	UNIT
$V_{OS}$	Input Offset Voltage		-150	25	150	$\mu\text{V}$
			<b>-270</b>		<b>270</b>	$\mu\text{V}$
$TCV_{OS}$	Input Offset Voltage Temperature Coefficient		<b>-1.2</b>	<b>0.2</b>	<b>1.2</b>	$\mu\text{V}/^\circ\text{C}$
$I_B$	Input Bias Current		-575	-230		nA
			<b>-800</b>			nA
$TCI_B$	Input Bias Current Temperature Coefficient			<b>-0.8</b>		$\text{nA}/^\circ\text{C}$
$I_{OS}$	Input Offset Current		-50	4	50	nA
			<b>-75</b>		<b>75</b>	nA
CMRR	Common-Mode Rejection Ratio	$V_{CM} = V_- - 0.5V$ to $V_+ - 1.8V$		119		dB
		$V_{CM} = V_-$ to $V_+ - 1.8V$	101	117		dB
			<b>96</b>			dB
$V_{CMIR}$	Common Mode Input Voltage Range	Guaranteed by CMRR test	$V_- - 0.5$		$V_+ - 1.8$	V
			<b><math>V_-</math></b>		<b><math>V_+ - 1.8</math></b>	V
PSRR	Power Supply Rejection Ratio	$V_S = 3V$ to $10V$ , $V_{CMIR} = \text{Valid Input Voltage}$	108	124		dB
			<b>103</b>			dB

**Electrical Specifications,  $V_S \pm 5V$**   $V_{CM} = 0, V_O = 0V, T_A = +25^\circ C$ , unless otherwise noted. **Boldface limits apply over the operating temperature range,  $-55^\circ C$  to  $+125^\circ C$ . Temperature data established by characterization. (Continued)**

PARAMETER	DESCRIPTION	CONDITIONS	MIN (Note 6)	TYP	MAX (Note 6)	UNIT
$A_{VOL}$	Open-Loop Gain	$V_O = -3V$ to $+3V, R_L = 10k\Omega$ to ground	120	132		dB
			<b>110</b>			dB
$V_{OL}$	Output Voltage Low, $V_{OUT}$ to $V_-$	$R_L = 10k\Omega$			38	mV
					<b>45</b>	mV
$V_{OH}$	Output Voltage High, $V_+$ to $V_{OUT}$	$R_L = 10k\Omega$			65	mV
					<b>70</b>	mV
$I_S$	Supply Current/Amplifier	$R_L = \text{Open}$		0.85	1.1	mA
					<b>1.4</b>	mA
$I_{SC+}$	Output Short Circuit Source Current	$R_L = 10\Omega$ to $V_-$		13		mA
$I_{SC-}$	Output Short Circuit Sink Current	$R_L = 10\Omega$ to $V_+$		20		mA
<b>AC SPECIFICATIONS</b>						
GBWP	Gain Bandwidth Product	$A_{CL} = 101, V_{OUT} = 100mV_{P-P}; R_L = 2k$		3.2		MHz
$e_{n-p-p}$	Voltage Noise	0.1Hz to 10Hz		320		nV <sub>P-P</sub>
$e_n$	Voltage Noise Density	$f = 10\text{Hz}$		9		nV/ $\sqrt{\text{Hz}}$
$e_n$	Voltage Noise Density	$f = 100\text{Hz}$		5.7		nV/ $\sqrt{\text{Hz}}$
$e_n$	Voltage Noise Density	$f = 1\text{kHz}$		5.5		nV/ $\sqrt{\text{Hz}}$
$e_n$	Voltage Noise Density	$f = 10\text{kHz}$		5.5		nV/ $\sqrt{\text{Hz}}$
$i_n$	Current Noise Density	$f = 1\text{kHz}$		380		fA/ $\sqrt{\text{Hz}}$
THD + N	Total Harmonic Distortion + Noise	1kHz, $G = 1, V_O = 1.25V_{RMS}, R_L = 10k\Omega$		0.0003		%
<b>TRANSIENT RESPONSE</b>						
SR	Slew Rate	$A_V = 1, R_L = 2k\Omega, V_O = 4V_{P-P}$		$\pm 1$		V/ $\mu\text{s}$
$t_r, t_f$ , Small Signal	Rise Time 10% to 90% of $V_{OUT}$	$A_V = 1, V_{OUT} = 100mV_{P-P}, R_f = 0\Omega, R_L = 2k\Omega$ to $V_{CM}$		100		ns
	Fall Time 90% to 10% of $V_{OUT}$	$A_V = 1, V_{OUT} = 100mV_{P-P}, R_f = 0\Omega, R_L = 2k\Omega$ to $V_{CM}$		100		ns
$t_s$	Settling Time to 0.01% 4V Step; 10% to $V_{OUT}$	$A_V = 1, V_{OUT} = 4V_{P-P}, R_f = 0\Omega, R_L = 2k\Omega$ to $V_{CM}$		4		$\mu\text{s}$

**NOTE:**

6. Compliance to datasheet limits is assured by one or more methods: production test, characterization and/or design.

# Typical Performance Curves

$V_S = \pm 15V, V_{CM} = 0V, R_L = \text{Open}$ , unless otherwise specified.

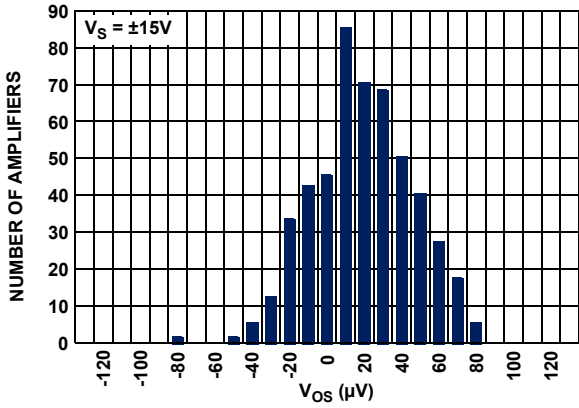

FIGURE 3. ISL28118M INPUT OFFSET VOLTAGE DISTRIBUTION,  $V_S = \pm 15V$

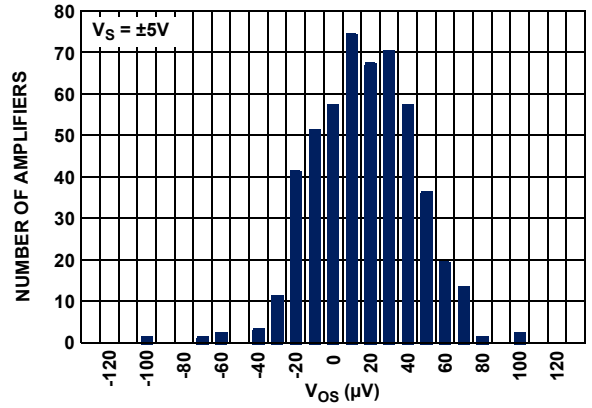

FIGURE 4. ISL28118M INPUT OFFSET VOLTAGE DISTRIBUTION,  $V_S = \pm 5V$

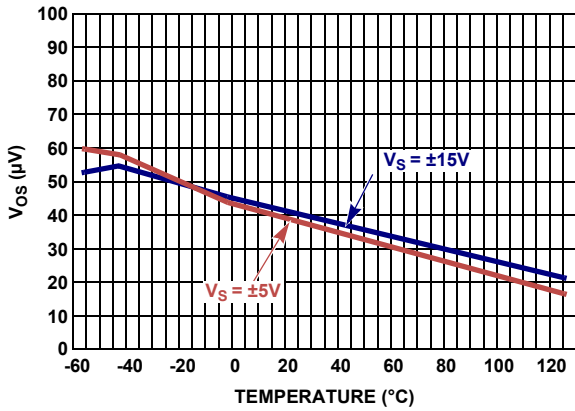

FIGURE 5.  $V_{OS}$  vs TEMPERATURE

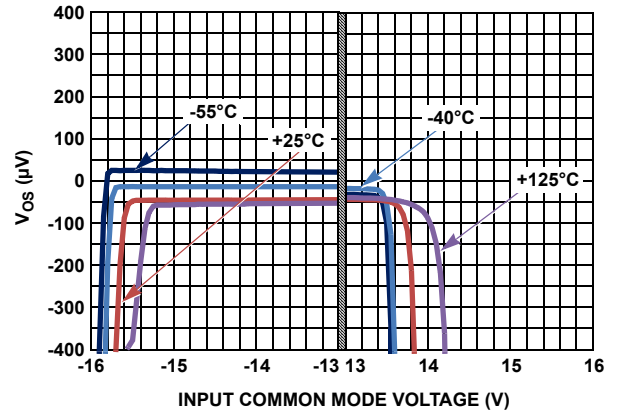

FIGURE 6. INPUT OFFSET VOLTAGE vs INPUT COMMON MODE VOLTAGE,  $-55^\circ C$  to  $+125^\circ C, V_S = \pm 15V$

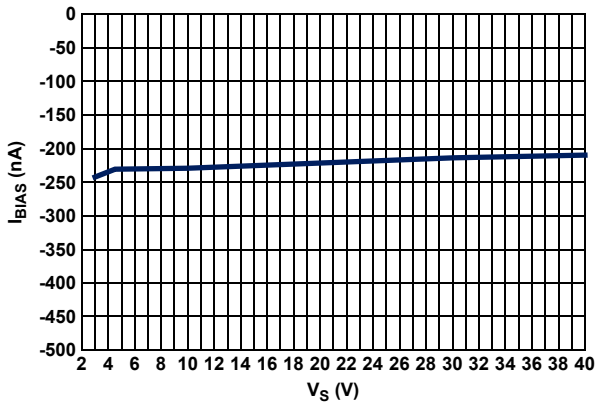

FIGURE 7.  $I_{BIAS}$  vs  $V_S$

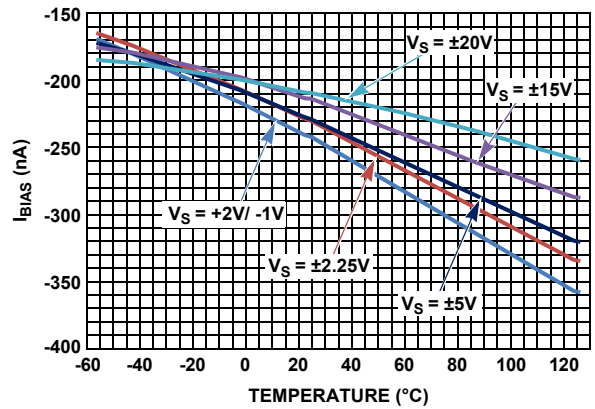

FIGURE 8.  $I_{BIAS}$  vs TEMPERATURE vs SUPPLY

**Typical Performance Curves**  $V_S = \pm 15V, V_{CM} = 0V, R_L = \text{Open}$ , unless otherwise specified. (Continued)

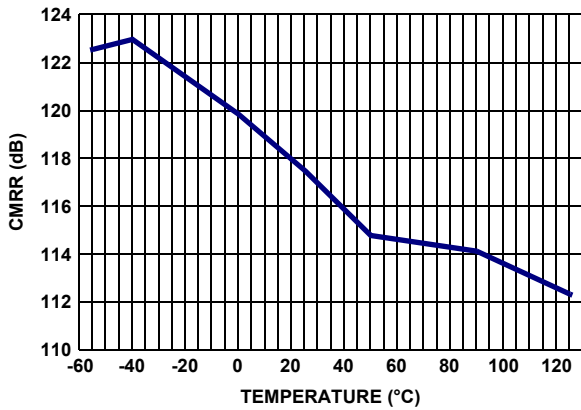

FIGURE 9. ISL28118M CMRR vs TEMPERATURE,  $V_S = \pm 15V$

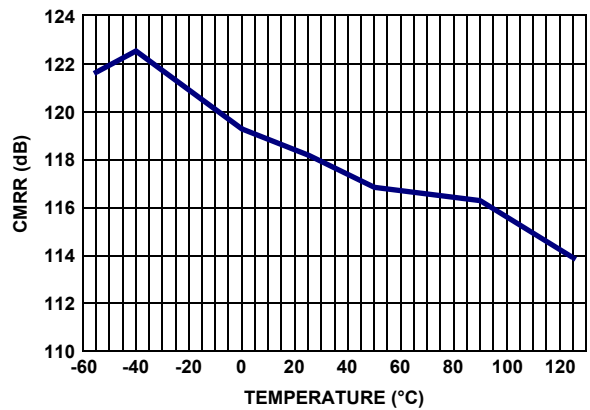

FIGURE 10. ISL28118M CMRR vs TEMPERATURE,  $V_S = \pm 5V$

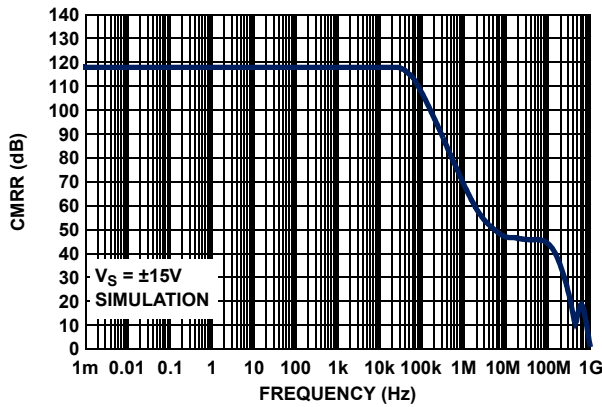

FIGURE 11. CMRR vs FREQUENCY,  $V_S = \pm 15V$

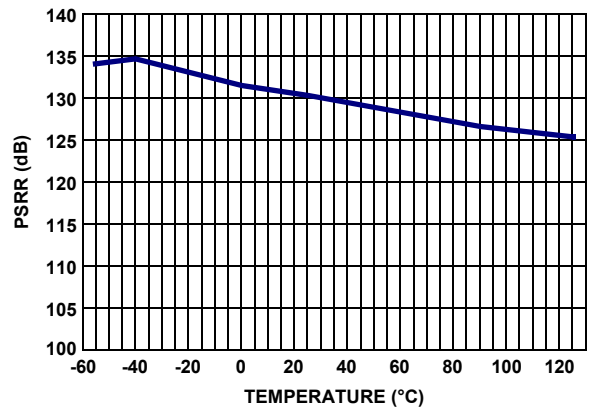

FIGURE 12. PSRR vs TEMPERATURE,  $V_S = \pm 15V$

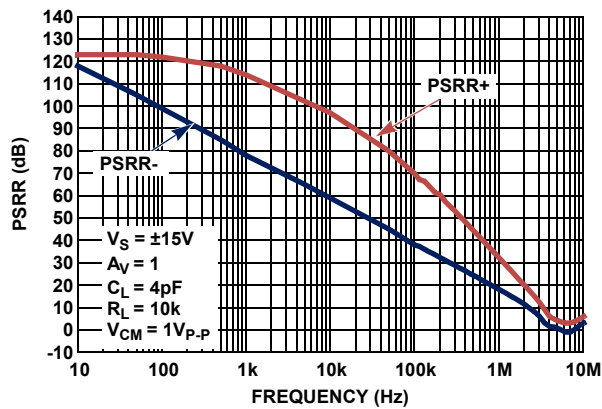

FIGURE 13. PSRR vs FREQUENCY,  $V_S = \pm 15V$

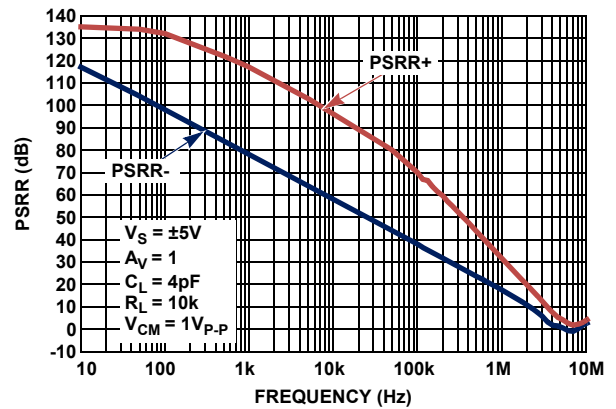

FIGURE 14. PSRR vs FREQUENCY,  $V_S = \pm 5V$



**Typical Performance Curves**  $V_S = \pm 15V, V_{CM} = 0V, R_L = \text{Open}$ , unless otherwise specified. (Continued)

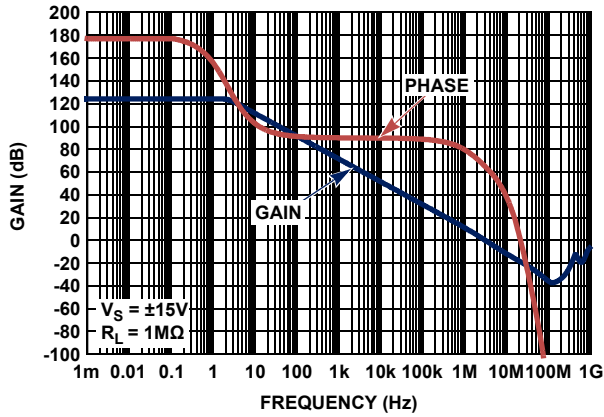

FIGURE 15. OPEN-LOOP GAIN, PHASE vs FREQUENCY,  $V_S = \pm 15V$

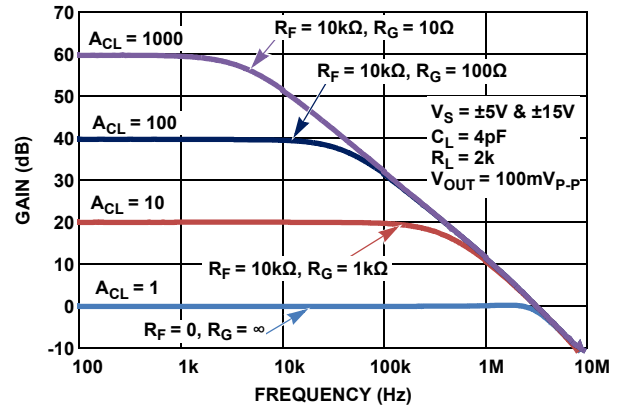

FIGURE 16. FREQUENCY RESPONSE vs CLOSED LOOP GAIN

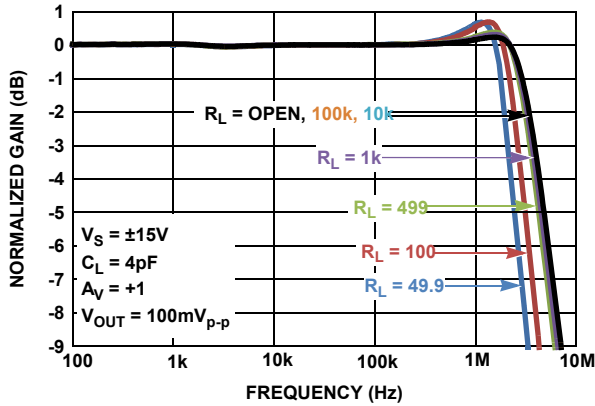

FIGURE 17. GAIN vs FREQUENCY vs  $R_L, V_S = \pm 15V$

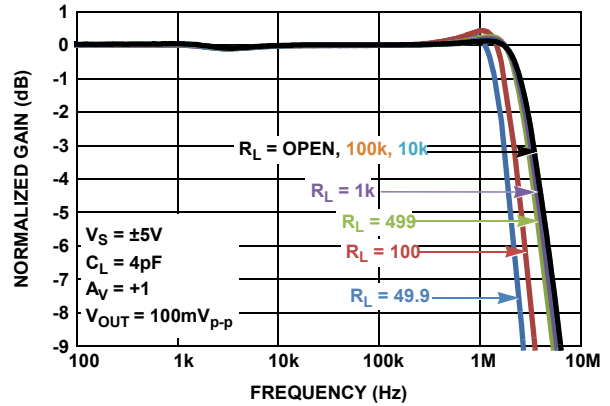

FIGURE 18. GAIN vs FREQUENCY vs  $R_L, V_S = \pm 5V$

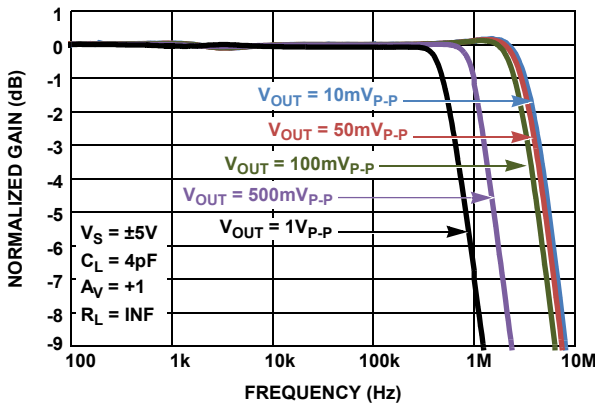

FIGURE 19. GAIN vs FREQUENCY vs OUTPUT VOLTAGE

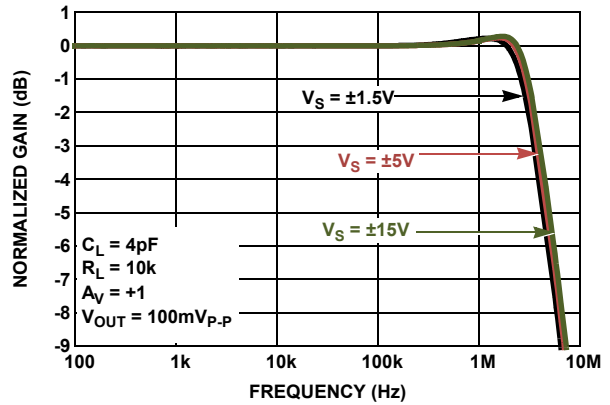
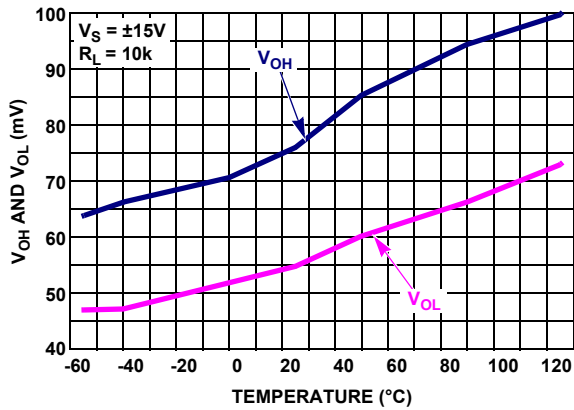
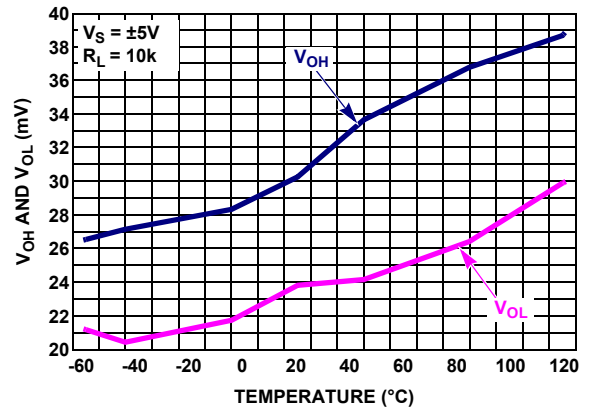

FIGURE 20. GAIN vs FREQUENCY vs SUPPLY VOLTAGE

**Typical Performance Curves**  $V_S = \pm 15V, V_{CM} = 0V, R_L = \text{Open}$ , unless otherwise specified. (Continued)



**FIGURE 21. OUTPUT OVERHEAD VOLTAGE vs TEMPERATURE,  $V_S = \pm 15V, R_L = 10k$**



**FIGURE 22. OUTPUT OVERHEAD VOLTAGE vs TEMPERATURE,  $V_S = \pm 5V, R_L = 10k$**

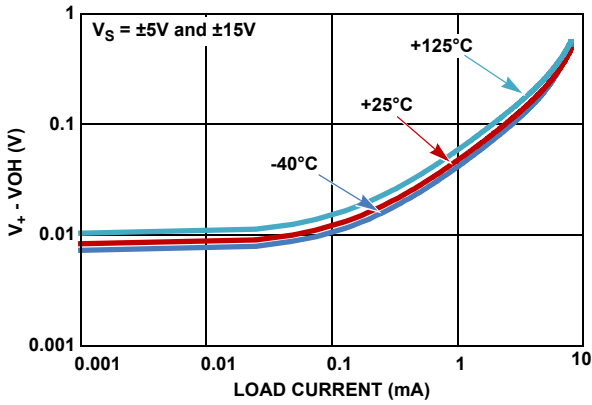

**FIGURE 23. OUTPUT OVERHEAD VOLTAGE HIGH vs LOAD CURRENT, -40°C to +125°C,  $V_S = \pm 5V$  AND  $\pm 15V$**

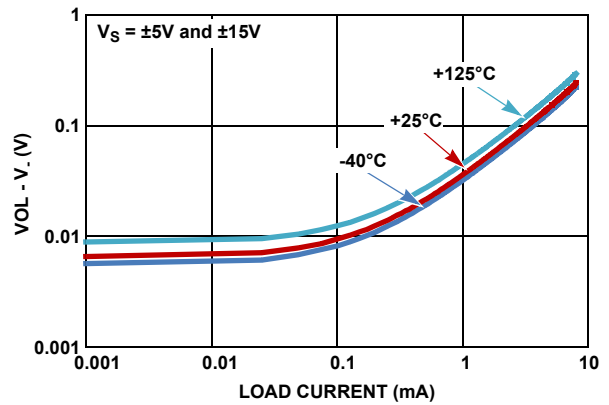

**FIGURE 24. OUTPUT OVERHEAD VOLTAGE LOW vs LOAD CURRENT, -40°C to +125°C,  $V_S = \pm 5V$  AND  $\pm 15V$**

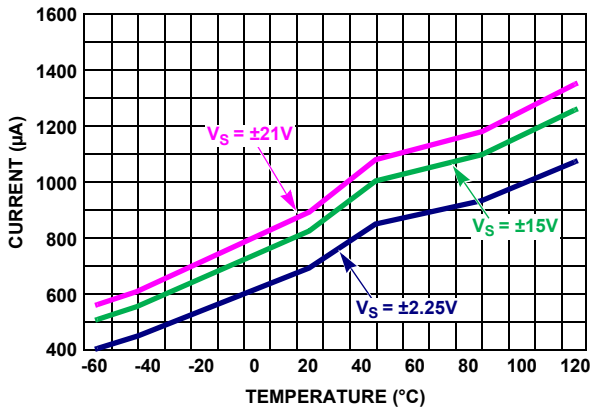

**FIGURE 25. ISL28118M SUPPLY CURRENT vs TEMPERATURE vs SUPPLY VOLTAGE**

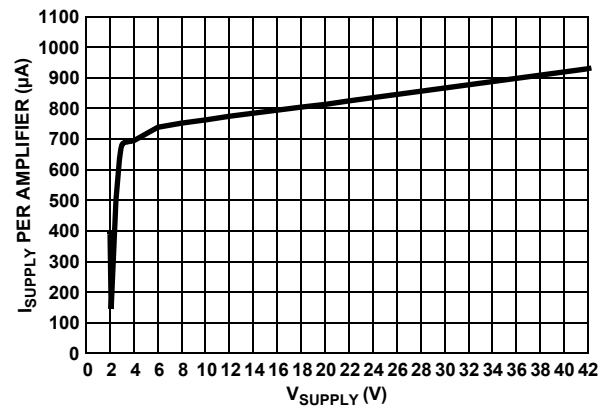

**FIGURE 26. SUPPLY CURRENT vs SUPPLY VOLTAGE**

**Typical Performance Curves**  $V_S = \pm 15V, V_{CM} = 0V, R_L = \text{Open}$ , unless otherwise specified. (Continued)

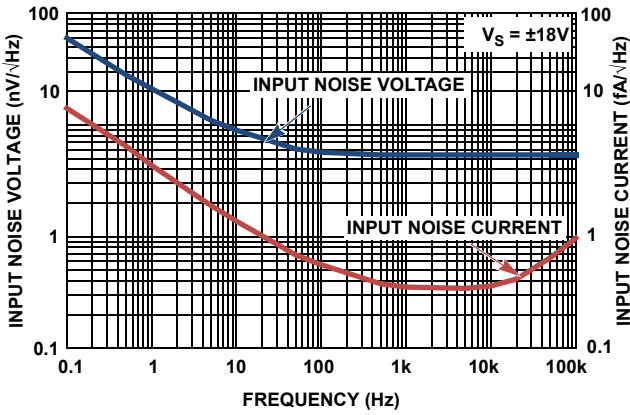

FIGURE 27. INPUT NOISE VOLTAGE ( $e_n$ ) AND INPUT NOISE CURRENT ( $i_n$ ) vs FREQUENCY,  $V_S = \pm 18V$

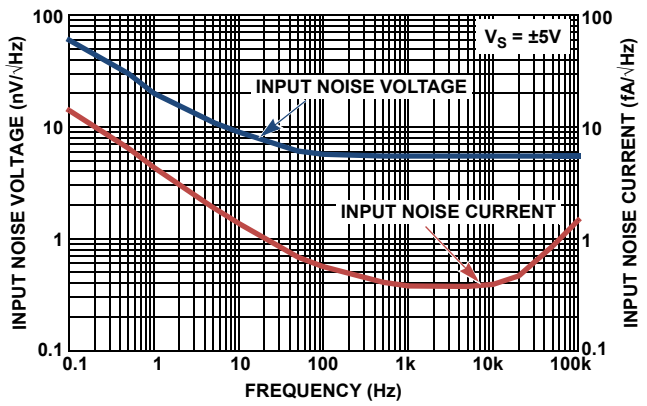

FIGURE 28. INPUT NOISE VOLTAGE ( $e_n$ ) AND INPUT NOISE CURRENT ( $i_n$ ) vs FREQUENCY,  $V_S = \pm 5V$

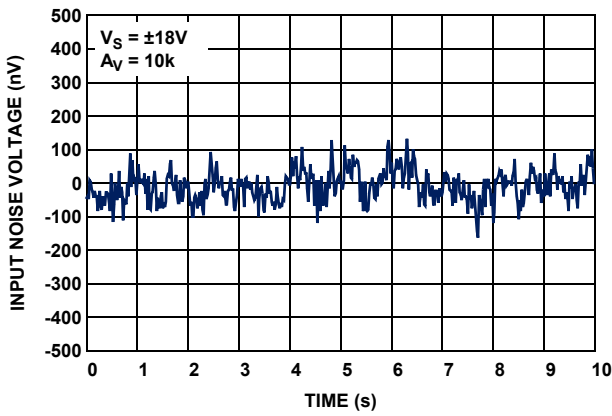

FIGURE 29. INPUT NOISE VOLTAGE 0.1Hz TO 10Hz,  $V_S = \pm 18V$

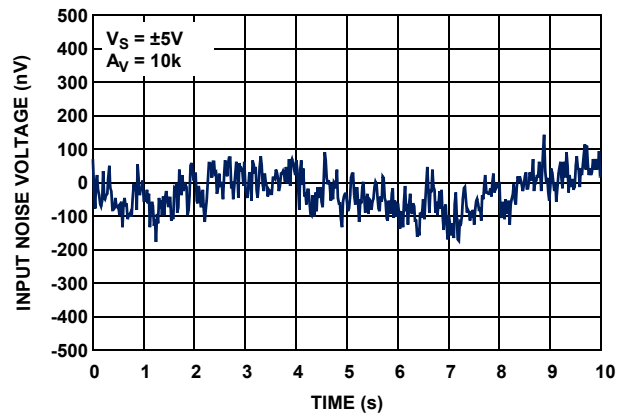

FIGURE 30. INPUT NOISE VOLTAGE 0.1Hz TO 10Hz,  $V_S = \pm 5V$

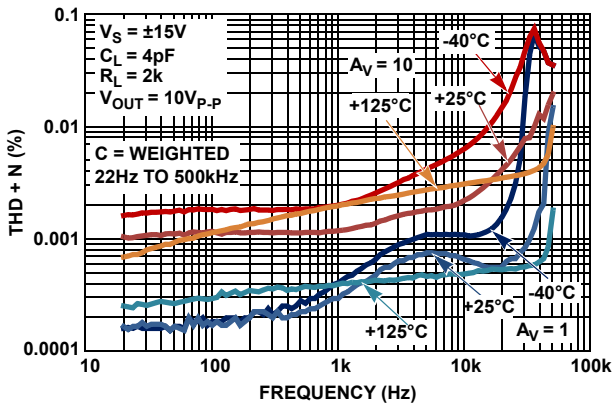

FIGURE 31. THD+N vs FREQUENCY vs TEMPERATURE,  $A_V = 1, 10, R_L = 2k$

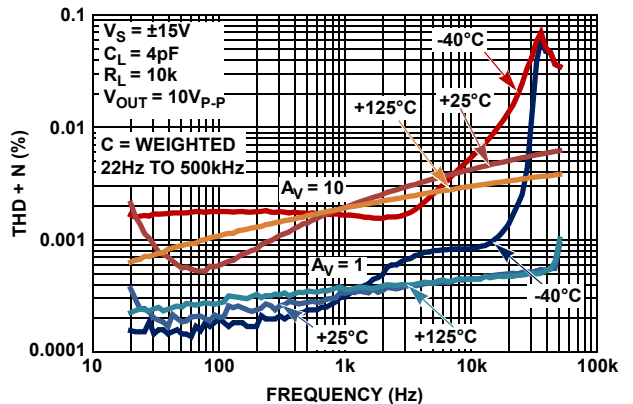

FIGURE 32. THD+N vs FREQUENCY vs TEMPERATURE,  $A_V = 1, 10, R_L = 10k$

**Typical Performance Curves**  $V_S = \pm 15V, V_{CM} = 0V, R_L = \text{Open}$ , unless otherwise specified. (Continued)

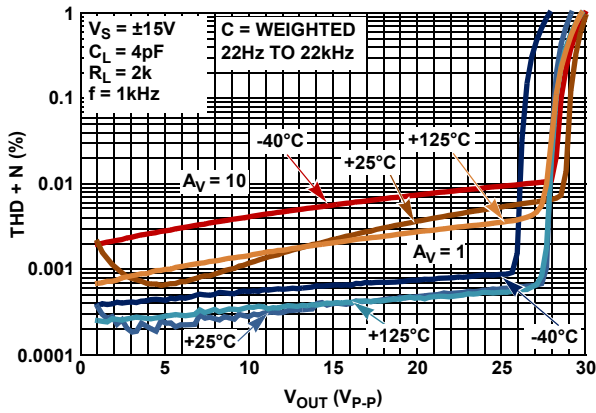

FIGURE 33. THD+N vs OUTPUT VOLTAGE ( $V_{OUT}$ ) vs TEMPERATURE,  $A_V = 1, 10, R_L = 2k$

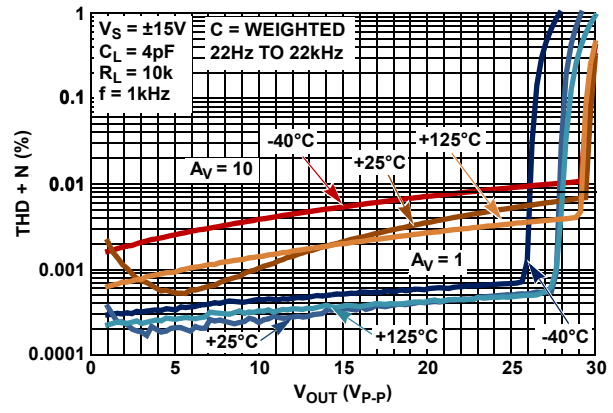

FIGURE 34. THD+N vs OUTPUT VOLTAGE ( $V_{OUT}$ ) vs TEMPERATURE,  $A_V = 1, 10, R_L = 10k$

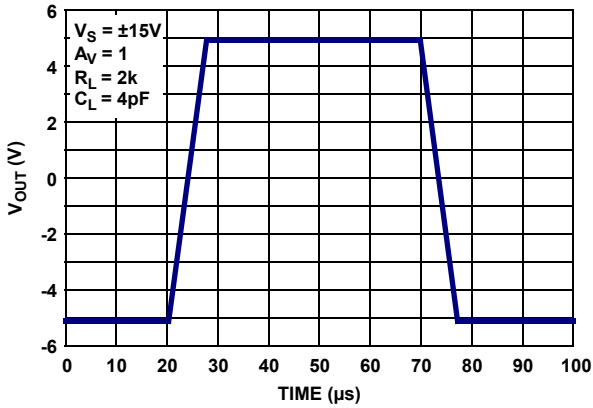

FIGURE 35. LARGE SIGNAL 10V STEP RESPONSE,  $V_S = \pm 15V$

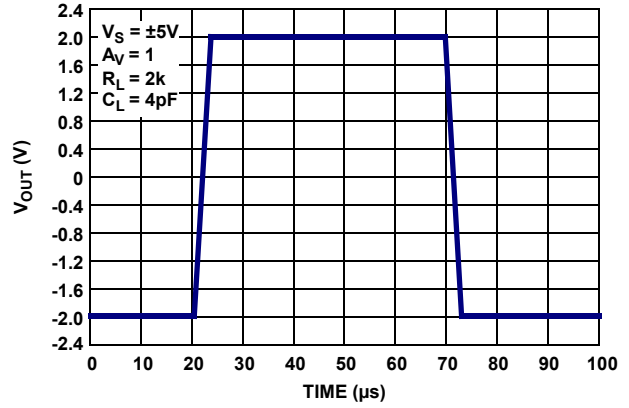

FIGURE 36. LARGE SIGNAL 4V STEP RESPONSE,  $V_S = \pm 5V$

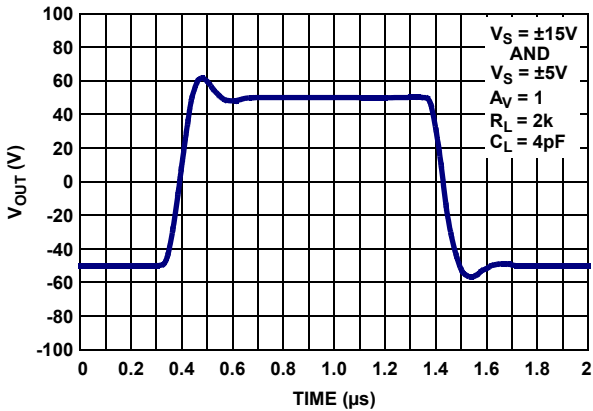

FIGURE 37. SMALL SIGNAL TRANSIENT RESPONSE,  $V_S = \pm 5V, \pm 15V$

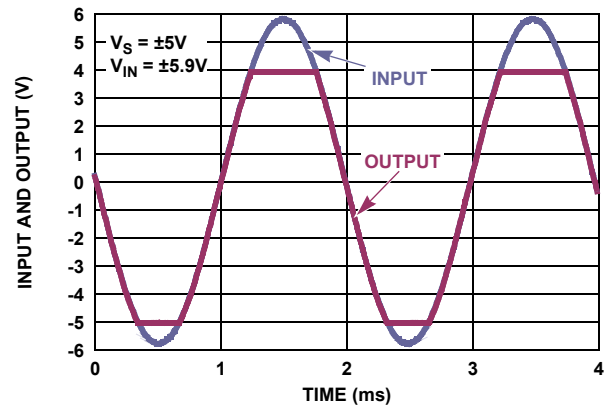

FIGURE 38. NO PHASE REVERSAL

**Typical Performance Curves**  $V_S = \pm 15V, V_{CM} = 0V, R_L = \text{Open}$ , unless otherwise specified. (Continued)

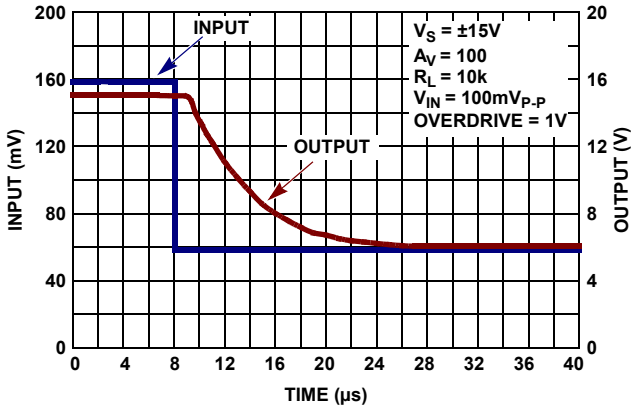

FIGURE 39. POSITIVE OUTPUT OVERLOAD RESPONSE TIME,  $V_S = \pm 15V$

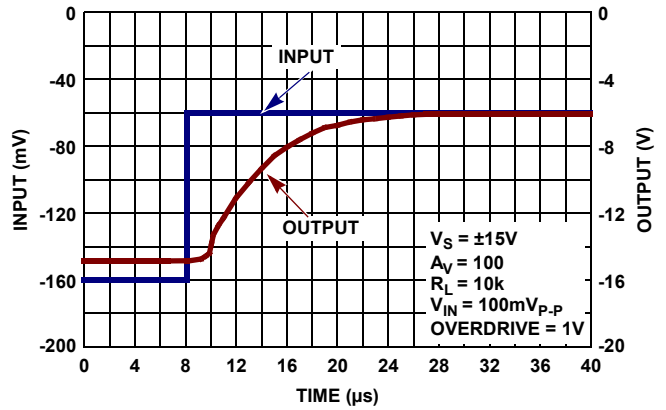

FIGURE 40. NEGATIVE OUTPUT OVERLOAD RESPONSE TIME,  $V_S = \pm 15V$

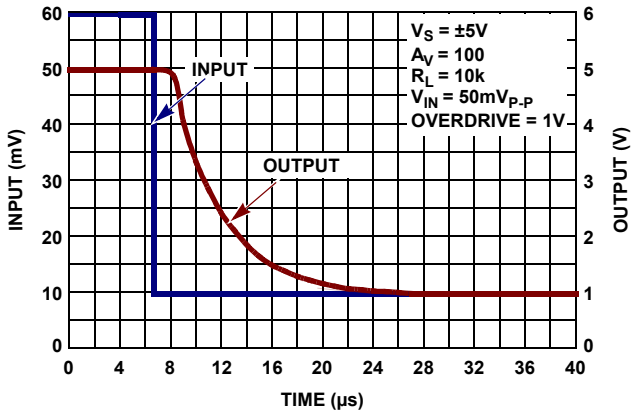

FIGURE 41. POSITIVE OUTPUT OVERLOAD RESPONSE TIME,  $V_S = \pm 5V$

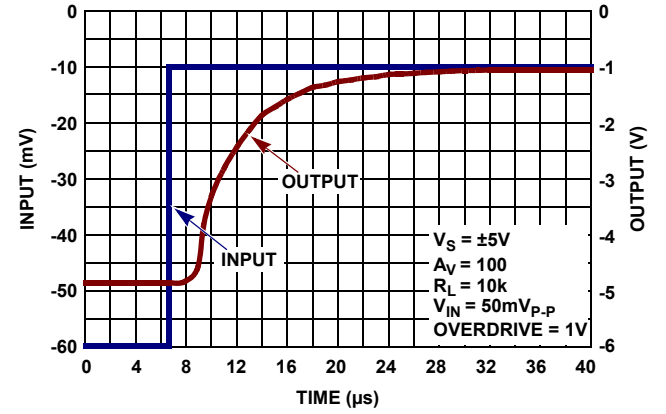

FIGURE 42. NEGATIVE OUTPUT OVERLOAD RESPONSE TIME,  $V_S = \pm 5V$

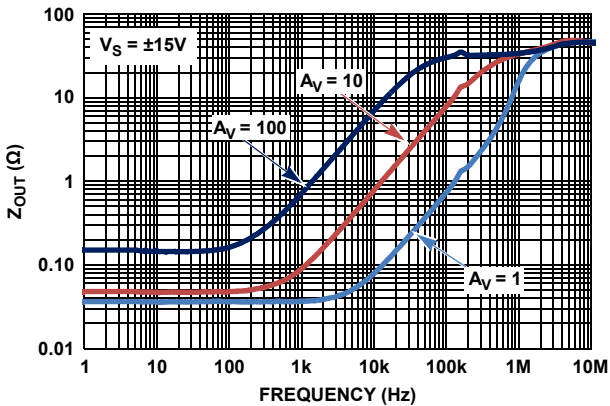

FIGURE 43. OUTPUT IMPEDANCE vs FREQUENCY,  $V_S = \pm 15V$

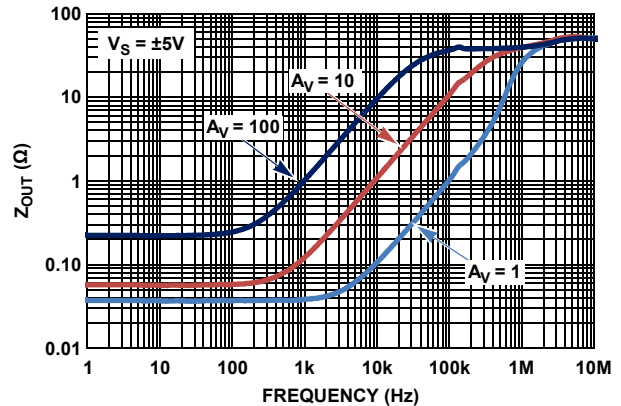

FIGURE 44. OUTPUT IMPEDANCE vs FREQUENCY,  $V_S = \pm 5V$

**Typical Performance Curves**  $V_S = \pm 15V, V_{CM} = 0V, R_L = \text{Open}$ , unless otherwise specified. (Continued)

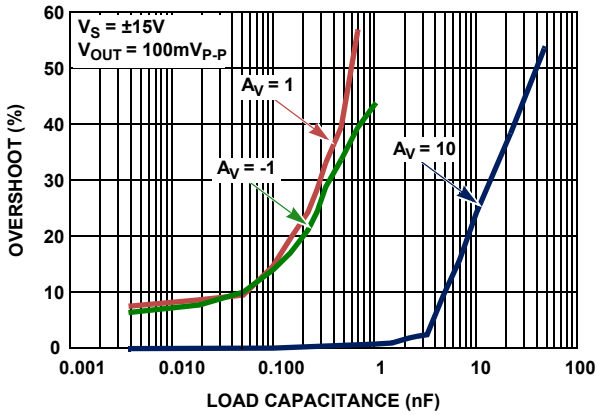

FIGURE 45. OVERSHOOT vs CAPACITIVE LOAD,  $V_S = \pm 15V$

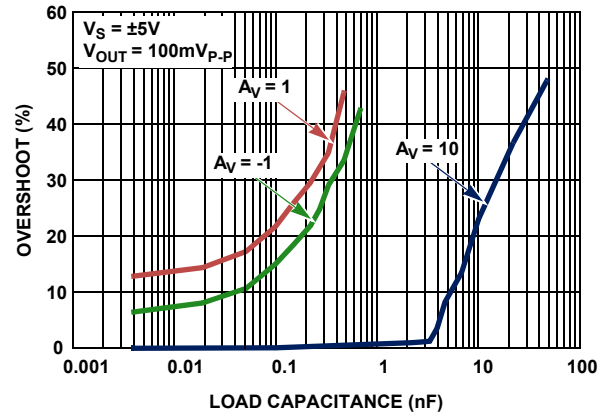

FIGURE 46. OVERSHOOT vs CAPACITIVE LOAD,  $V_S = \pm 5V$

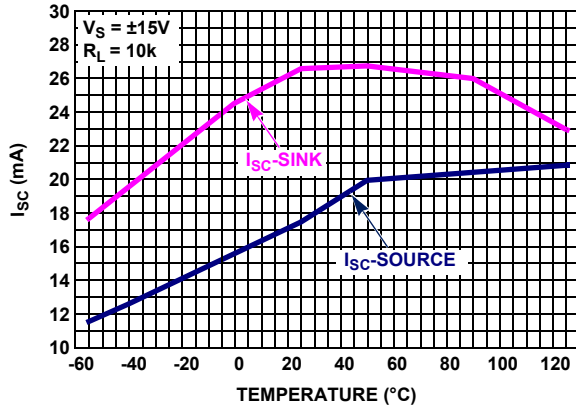

FIGURE 47. ISL28118M SHORT CIRCUIT CURRENT vs TEMPERATURE,  $V_S = \pm 15V$

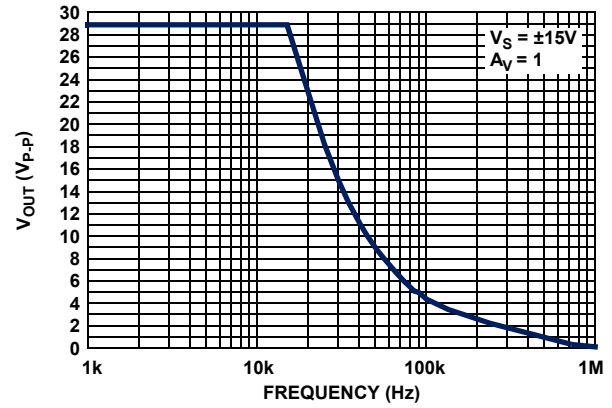

FIGURE 48. MAX OUTPUT VOLTAGE vs FREQUENCY

## Applications Information

### Functional Description

The ISL28118M is a 3.2MHz, single-supply, rail-to-rail output amplifier with a common mode input voltage range extending to a range of 0.5V below the V- rail. The input stage is optimized for precision sensing of ground-referenced signals in single-supply applications. The input stage is able to handle large input differential voltages without phase inversion, making this amplifier suitable for high-voltage comparator applications. The bipolar design features high open loop gain, excellent DC input/output temperature stability with a low quiescent current of 850 $\mu$ V, and low temperature drift. The op amp is fabricated in a new precision 40V complementary bipolar DI process and is immune from latch-up.

### Operating Voltage Range

The op amp is designed to operate over a single supply range of 3V to 40V or a split supply voltage range of +1.8V, -1.2V to  $\pm$ 20V. The device is fully characterized at 10V ( $\pm$ 5V) and 30V ( $\pm$ 15V). Both DC and AC performance remain virtually unchanged over the complete operating voltage range. Parameter variation with operating voltage is shown in the "Typical Performance Curves" beginning on page 7.

The input common mode voltage to the V+ rail (V+ -1.8V over the full temperature range) may limit amplifier operation when operating from split V+ and V- supplies. Figure 6 shows the common mode input voltage range variation over-temperature.

### Input Stage Performance

The ISL28118M PNP input stage has a common mode input range extending up to 0.5V below ground at +25 $^{\circ}$ C (Figure 6). Full amplifier performance is guaranteed with input voltage down to ground (V-) over the -55 $^{\circ}$ C to +125 $^{\circ}$ C temperature range. For common mode voltages down to -0.5V below ground (V-), the amplifiers are fully functional, but performance degrades slightly over the full temperature range. This feature provides excellent CMRR, AC performance, and DC accuracy when amplifying low-level, ground-referenced signals.

The input stage has a maximum input differential voltage equal to a diode drop greater than the supply voltage (max 42V) and does not contain the back-to-back input protection diodes found on many similar amplifiers. This feature enables the device to function as a precision comparator by maintaining very high input impedance for high-voltage differential input comparator voltages. The high differential input impedance also enables the device to operate reliably in large signal pulse applications, without the need for anti-parallel clamp diodes required on MOSFET and most bipolar input stage op amps. Thus, input signal distortion caused by nonlinear clamps under high slew rate conditions is avoided.

In applications where one or both amplifier input terminals are at risk of exposure to voltages beyond the supply rails, current-limiting resistors may be needed at each input terminal (see Figure 49, R<sub>IN+</sub>, R<sub>IN-</sub>) to limit current through the power-supply ESD diodes to 20mA.

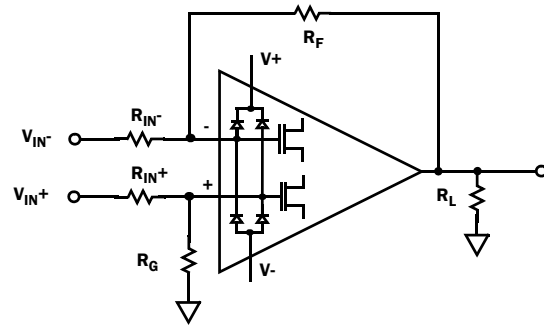

FIGURE 49. INPUT ESD DIODE CURRENT LIMITING

### Output Drive Capability

The bipolar rail-to-rail output stage features low saturation levels that enable an output voltage swing to less than 15mV when the total output load (including feedback resistance) is held below 50 $\mu$ A. With  $\pm$ 15V supplies, this can be achieved by using feedback resistor values >300k $\Omega$ .

The output stage is internally current limited. The amplifiers can withstand a short circuit to either rail as long as the power dissipation limits are not exceeded. Continuous operation under these conditions may degrade long-term reliability.

The amplifiers perform well when driving capacitive loads (Figures 45 and 46). The unity gain, voltage follower (buffer) configuration provides the highest bandwidth but is also the most sensitive to ringing produced by load capacitance found in BNC cables. Unity gain overshoot is limited to 35% at capacitance values to 0.33nF. At gains of 10 and higher, the device is capable of driving more than 10nF without significant overshoot.

### Output Phase Reversal

Output phase reversal is a change of polarity in the amplifier transfer function when the input voltage exceeds the supply voltage. The ISL28118M is immune to output phase reversal for input voltage to 0.5V beyond the rail (V<sub>ABS MAX</sub>) limit (Figure 38).

### Power Dissipation

It is possible to exceed the +150 $^{\circ}$ C maximum junction temperatures under certain load and power supply conditions. It is therefore important to calculate the maximum junction temperature (T<sub>JMAX</sub>) for all applications to determine if power supply voltages, load conditions, or package type need to be modified to remain in the safe operating area. These parameters are related using Equation 1:

$$T_{JMAX} = T_{MAX} + \theta_{JA} \times PD_{MAXTOTAL} \quad (EQ. 1)$$

where

- PD<sub>MAXTOTAL</sub> is the sum of the maximum power dissipation of each amplifier in the package (PD<sub>MAX</sub>)
- T<sub>MAX</sub> = Maximum ambient temperature
- $\theta_{JA}$  = Thermal resistance of the package

$PD_{MAX}$  for each amplifier can be calculated using Equation 2:

$$PD_{MAX} = V_S \times I_{qMAX} + (V_S - V_{OUTMAX}) \times \frac{V_{OUTMAX}}{R_L} \quad (\text{EQ. 2})$$

where:

- $PD_{MAX}$  = Maximum power dissipation of 1 amplifier
- $V_S$  = Total supply voltage
- $I_{qMAX}$  = Maximum quiescent supply current of one amplifier
- $V_{OUTMAX}$  = Maximum output voltage swing of the application
- $R_L$  = Load resistance

## ISL28118M SPICE Model

Figure 50 shows the SPICE model schematic and Figure 51 shows the net list for the SPICE model. The model is a simplified version of the actual device and simulates important AC and DC parameters. AC parameters incorporated into the model are: 1/f and flatband noise voltage, slew rate, CMRR, and gain and phase. The DC parameters are  $I_{OS}$ , total supply current, and output voltage swing. The model uses typical parameters given in the “Electrical Specifications” table beginning on page 4. The AVOL is adjusted for 136dB with the dominant pole at 0.6Hz. The CMRR is set at 120dB,  $f = 50\text{kHz}$ . The input stage models the actual device to present an accurate AC representation. The model is configured for an ambient temperature of +25°C.

Figures 52 through 66 show the characterization vs simulation results for the noise voltage, open loop gain phase, closed loop gain vs frequency, gain vs frequency vs  $R_L$ , CMRR, large signal 10V step response, small signal 0.1V step, and output voltage swing  $\pm 15\text{V}$  supplies.

## LICENSE STATEMENT

The information in the SPICE model is protected under United States copyright laws. Intersil Corporation hereby grants users of this macro-model, hereto referred to as “Licensee”, a nonexclusive, nontransferable licence to use this model, as long as the Licensee abides by the terms of this agreement. Before using this macro-model, the Licensee should read this license. If the Licensee does not accept these terms, permission to use the model is not granted.

The Licensee may not sell, loan, rent, or license the macro-model, in whole, in part, or in modified form, to anyone outside the Licensee’s company. The Licensee may modify the macro-model to suit his/her specific applications, and the Licensee may make copies of this macro-model for use within their company only.

This macro-model is provided “AS IS, WHERE IS, AND WITH NO WARRANTY OF ANY KIND EITHER EXPRESSED OR IMPLIED, INCLUDING BUT NOT LIMITED TO ANY IMPLIED WARRANTIES OF MERCHANTABILITY AND FITNESS FOR A PARTICULAR PURPOSE.”

In no event will Intersil be liable for special, collateral, incidental, or consequential damages in connection with or arising out of the use of this macro-model. Intersil reserves the right to make changes to the product and the macro-model without prior notice.



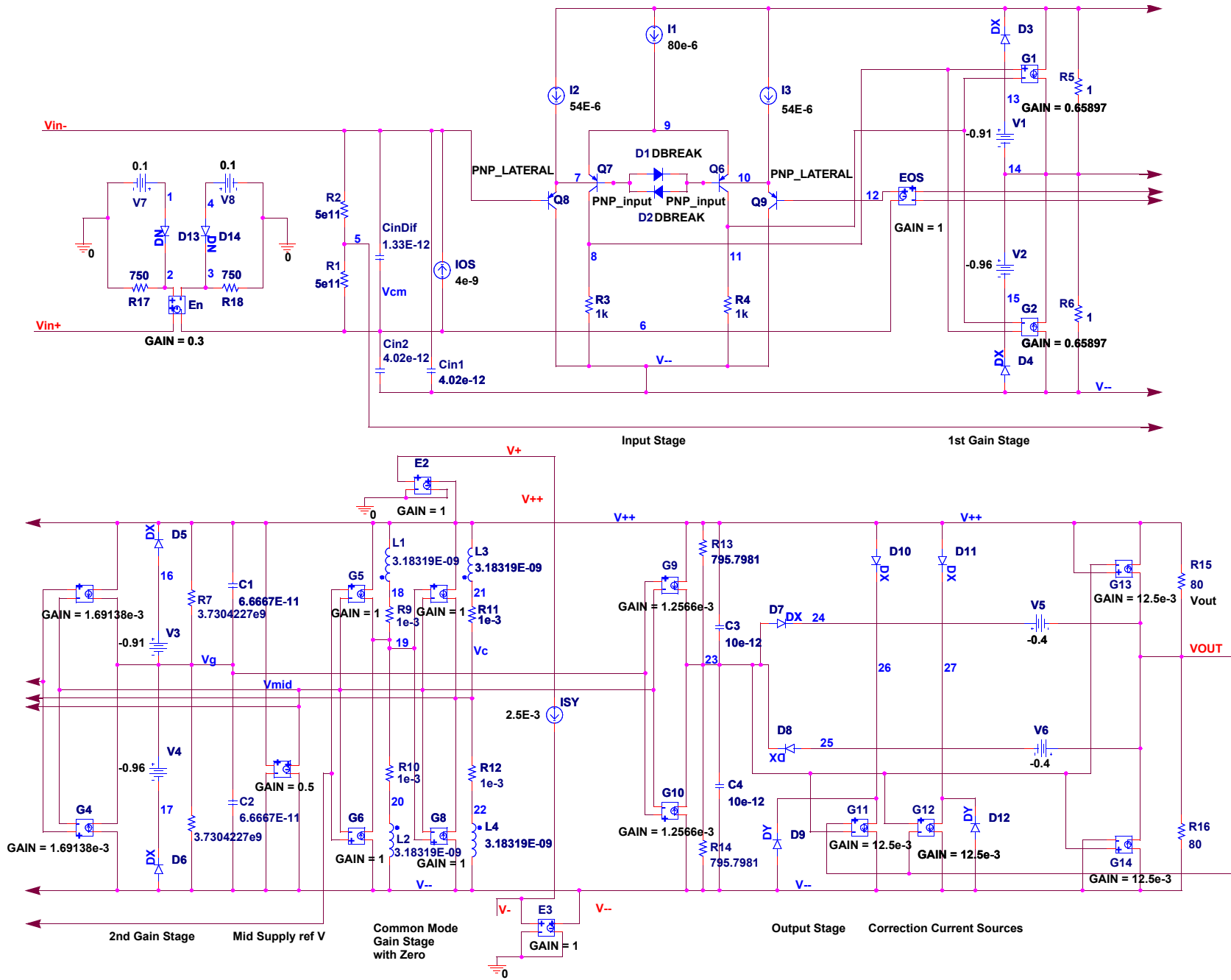

FIGURE 50. SPICE SCHEMATIC

\*ISL28118\_218 Macromodel - covers following \*products  
 \*ISL28118  
 \*ISL28218  
 \*  
 \*Revision History:  
 \* Revision B, LaFontaine January 22 2014  
 \* Model for Noise, supply currents, CMRR  
 \*120dB f = 40kHz, AVOL 136dB f = 0.5Hz  
 \* SR = 1.2V/us, GBWP 4MHz.  
 \*Copyright 2011 by Intersil Corporation  
 \*Refer to data sheet "LICENSE STATEMENT"  
 \*Use of this model indicates your acceptance  
 \*with the terms and provisions in the License  
 \*Statement.  
 \*  
 \*Intended use:  
 \*This Pspice Macromodel is intended to give  
 \*typical DC and AC performance  
 \*characteristics \*under a wide range of  
 \*external circuit \*configurations using  
 \*compatible simulation \*platforms – such as  
 \*iSim PE.  
 \*  
 \*Device performance features supported by  
 \*this \*model:  
 \*Typical, room temp., nominal power supply  
 \*voltages used to produce the following  
 \*characteristics:  
 \*Open and closed loop I/O impedances,  
 \*Open loop gain and phase,  
 \*Closed loop bandwidth and frequency  
 \*response,  
 \*Loading effects on closed loop frequency  
 \*response,  
 \*Input noise terms including 1/f effects,  
 \*Slew rate,  
 \*Input and Output Headroom limits to I/O  
 \*voltage swing,  
 \*Supply current at nominal specified supply  
 \*voltages,  
 \*  
 \*Device performance features NOT  
 \*supported \*by this model:  
 \*Harmonic distortion effects,  
 \*Output current limiting (current will limit at  
 \*40mA),  
 \*Disable operation (if any),  
 \*Thermal effects and/or over temperature  
 \*parameter variation,  
 \*Limited performance variation vs. supply  
 \*voltage is modeled,  
 \*Part to part performance variation due to  
 \*normal process parameter spread,  
 \*Any performance difference arising from  
 \*different packaging,  
 \*Load current reflected into the power supply  
 \*current.  
 \* source ISL28118\_218 SPICEmodel  
 \*  
 \* Connections:        +input  
 \*                        |        -input  
 \*                        |        |        +Vsupply  
 \*                        |        |        |        -Vsupply  
 \*                        |        |        |        |        output  
 .subckt ISL28118\_218 Vin+ Vin-V+ V- VOUT  
 \* source ISL28118\_218\_presubckt\_0  
 \*  
 \*Voltage Noise  
 E\_En        VIN+ 6 2 0 0.3  
 D\_D13       1 2 DN  
 D\_D14       1 2 DN  
 V\_V7        1 0 0.1

V\_V8        4 0 0.1  
 R\_R17       2 0 750  
 \*R\_R18       3 0 750  
 \*  
 \*Input Stage  
 Q\_Q6        11 10 9 PNP\_input  
 Q\_Q7        8 7 9 PNP\_input  
 Q\_Q8        V-- VIN- 7 PNP\_LATERAL  
 Q\_Q9        V-- 12 10 PNP\_LATERAL  
 I\_I1        V++ 9 DC 80e-6  
 I\_I2        V++ 7 DC 54E-6  
 I\_I3        V++ 10 DC 54E-6  
 I\_IOS       6 VIN- DC 4e-9  
 D\_D1        7 10 DBREAK  
 D\_D2        10 7 DBREAK  
 R\_R1        5 6 5e11  
 R\_R2        VIN- 5 5e11  
 R\_R3        V-- 8 1000  
 R\_R4        V-- 11 1000  
 C\_Cin1       V-- VIN- 4.02E-12  
 C\_Cin2       V-- 6 4.02E-12  
 C\_CinDif    6 VIN- 1.33E-12  
 \*  
 \*1st Gain Stage  
 G\_G1        V++ 14 8 11 0.65897  
 G\_G2        V-- 14 8 11 0.65897  
 V\_V1        13 14 -0.91  
 V\_V2        14 15 -0.96  
 D\_D3        13 V++ DX  
 D\_D4        V-- 15 DX  
 R\_R5        14 V++ 1  
 R\_R6        V-- 14 1  
 \*  
 \*2nd Gain Stage  
 G\_G3        V++ VG 14 VMID 1.69138e-3  
 G\_G4        V-- VG 14 VMID 1.69138e-3  
 V\_V3        16 VG -0.91  
 V\_V4        VG 17 -0.96  
 D\_D5        16 V++ DX  
 D\_D6        V-- 17 DX  
 R\_R7        VG V++ 3.7304227e9  
 R\_R8        V-- VG 3.7304227e9  
 C\_C1        VG V++ 6.6667E-11  
 C\_C2        V-- VG 6.6667E-11  
 \*  
 \*Mid supply Ref  
 E\_E2        V++ 0 V+ 0 1  
 E\_E3        V-- 0 V- 0 1  
 E\_E4        VMID V-- V++ V-- 0.5  
 I\_ISY       V+ V- DC 0.85E-3  
 \*  
 \*Common Mode Gain Stage with Zero  
 G\_G5        V++ 19 5 VMID 1  
 G\_G6        V-- 19 5 VMID 1  
 G\_G7        V++ VC 19 VMID 1  
 G\_G8        V-- VC 19 VMID 1  
 E\_EOS       12 6 VC VMID 1  
 L\_L1        18 V++ 3.18319E-09  
 L\_L2        20 V-- 3.18319E-09  
 L\_L3        21 V++ 3.18319E-09  
 L\_L4        22 V-- 3.18319E-09  
 R\_R9        19 18 1e-3  
 R\_R10       20 19 1e-3  
 R\_R11       VC 21 1e-3  
 R\_R12       22 VC 1e-3  
 \*  
 \*Pole Stage  
 G\_G9        V++ 23 VG VMID 1.2566e-3  
 G\_G10       V-- 23 VG VMID 1.2566e-3  
 R\_R13       23 V++ 795.7981

R\_R14       V-- 23 795.7981  
 C\_C3        23 V++ 10e-12  
 C\_C4        V-- 23 10e-12  
 \*  
 \*Output Stage with Correction Current  
 Sources  
 G\_G11       26 V-- VOUT 23 12.5e-3  
 G\_G12       27 V-- 23 VOUT 12.5e-3  
 G\_G13       VOUT V++ V++ 23 12.5e-3  
 G\_G14       V-- VOUT 23 V-- 12.5e-3  
 D\_D7        23 24 DX  
 D\_D8        25 23 DX  
 D\_D9        V-- 26 DY  
 D\_D10       V++ 26 DX  
 D\_D11       V++ 27 DX  
 D\_D12       V-- 27 DY  
 V\_V5        24 VOUT -0.4  
 V\_V6        VOUT 25 -0.4  
 R\_R15       VOUT V++ 80  
 R\_R16       V-- VOUT 80  
 .model PNP\_LATERAL pnp(is=1e-016  
 bf=250 va=80  
 + ik=0.138 rb=0.01 re=0.101 rc=180 kf=0  
 af=1)  
 .model PNP\_input pnp(is=1e-016 bf=100  
 va=80  
 + ik=0.138 rb=0.01 re=0.101 rc=180 kf=0  
 af=1)  
 .model DBREAK D(bv=43 rs=1)  
 .model DN D(KF=6.69e-9 AF=1)  
 .MODEL DX D(IS=1E-12 Rs=0.1)  
 .MODEL DY D(IS=1E-15 BV=50 Rs=1)  
 .ends ISL28118\_218

FIGURE 51. SPICE NET LIST

## Characterization vs Simulation Results

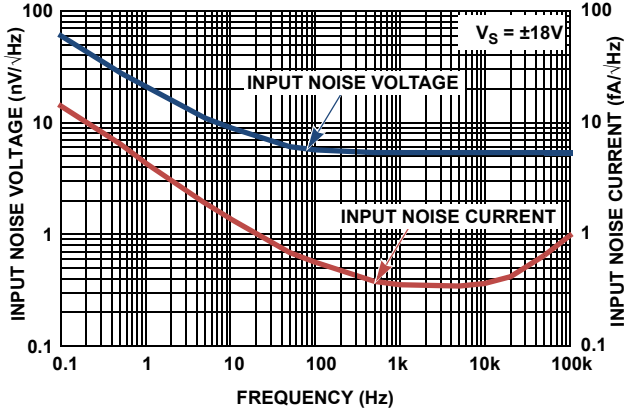

FIGURE 52. CHARACTERIZED INPUT NOISE VOLTAGE

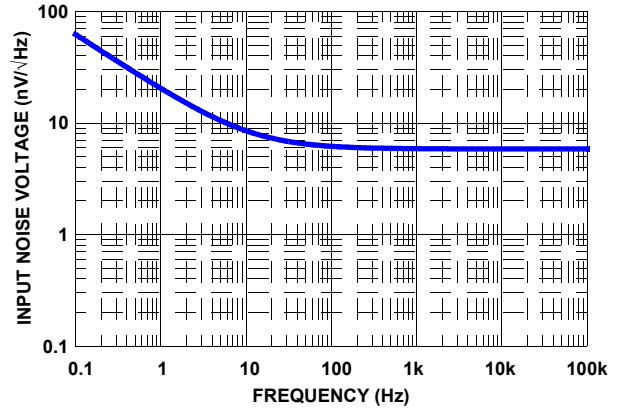

FIGURE 53. SIMULATED INPUT NOISE VOLTAGE

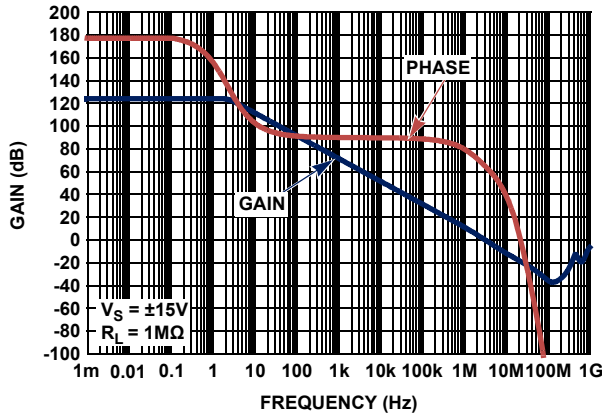

FIGURE 54. CHARACTERIZED OPEN-LOOP GAIN, PHASE vs FREQUENCY

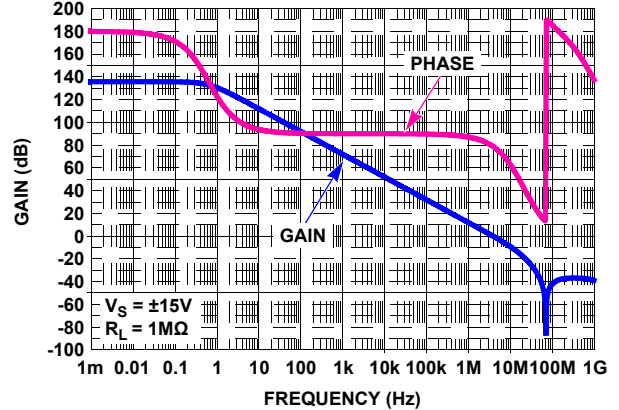

FIGURE 55. SIMULATED OPEN-LOOP GAIN, PHASE vs FREQUENCY

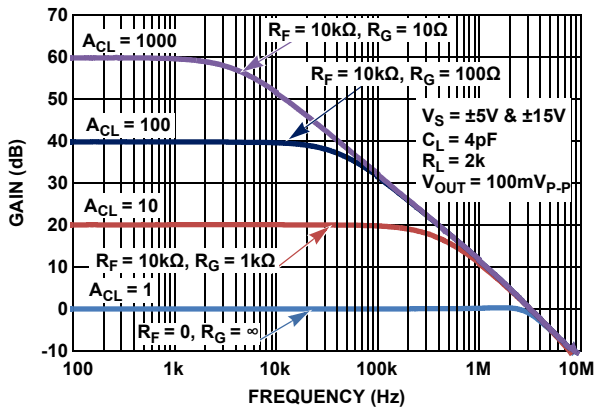

FIGURE 56. CHARACTERIZED CLOSED-LOOP GAIN vs FREQUENCY

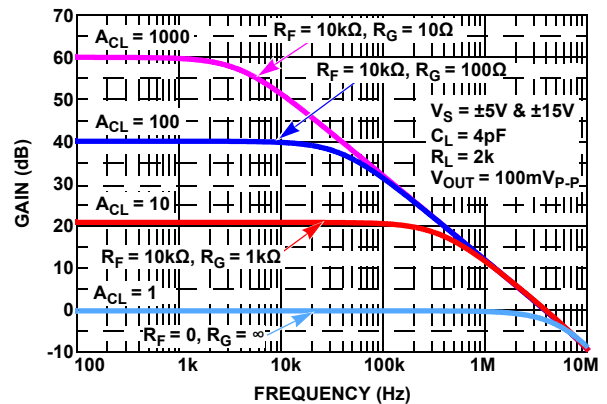

FIGURE 57. SIMULATED CLOSED-LOOP GAIN vs FREQUENCY

## Characterization vs Simulation Results (Continued)

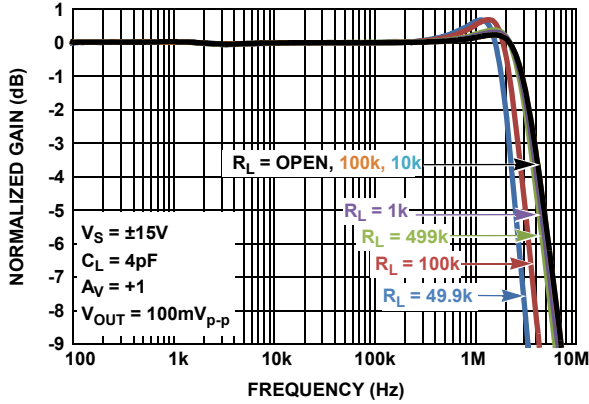

FIGURE 58. CHARACTERIZED GAIN vs FREQUENCY vs  $R_L$

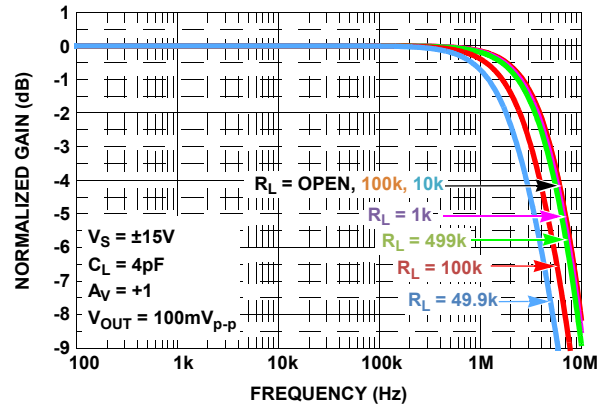

FIGURE 59. SIMULATED GAIN vs FREQUENCY vs  $R_L$

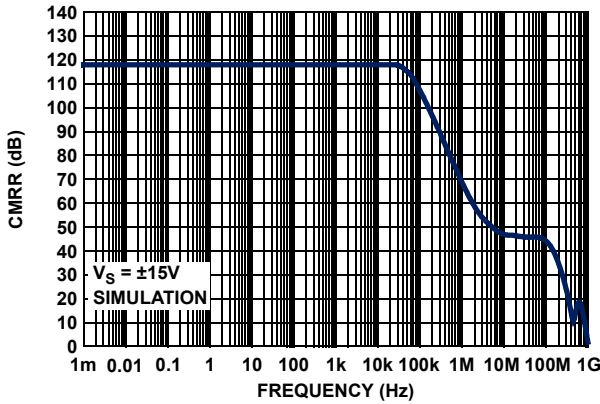

FIGURE 60. CHARACTERIZED CMRR vs FREQUENCY

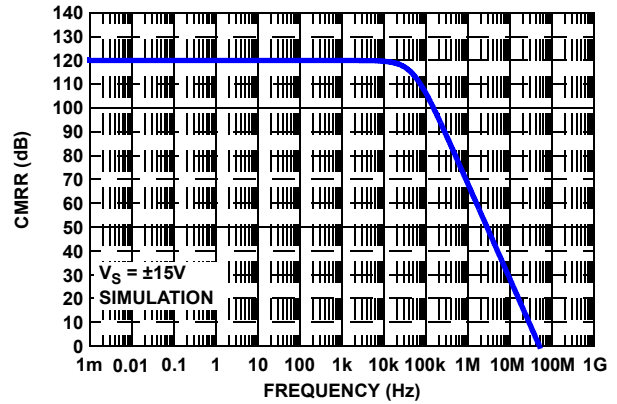

FIGURE 61. SIMULATED CMRR vs FREQUENCY

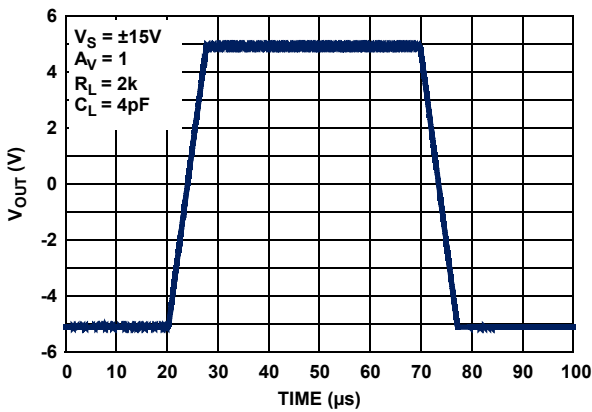

FIGURE 62. CHARACTERIZED LARGE-SIGNAL 10V STEP RESPONSE

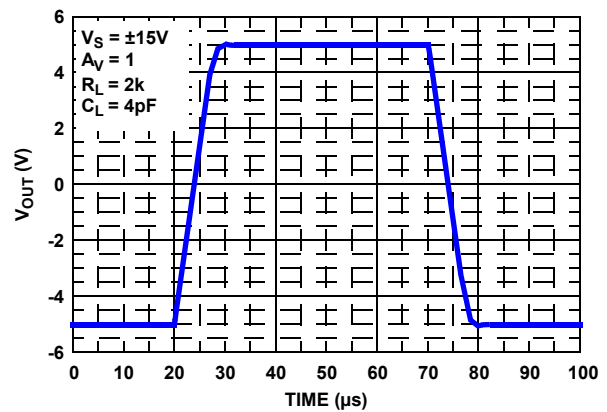

FIGURE 63. SIMULATED LARGE-SIGNAL 10V STEP RESPONSE

## Characterization vs Simulation Results (Continued)

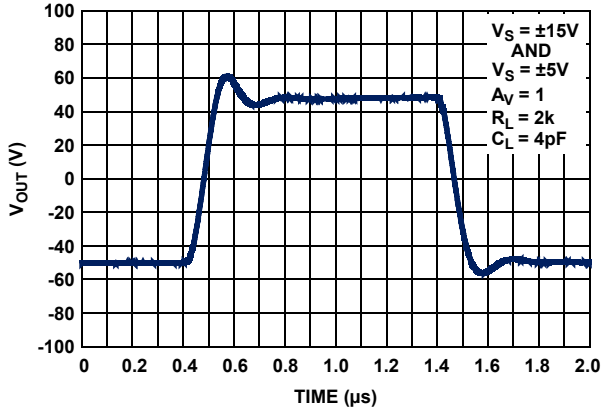

FIGURE 64. CHARACTERIZED SMALL-SIGNAL TRANSIENT RESPONSE

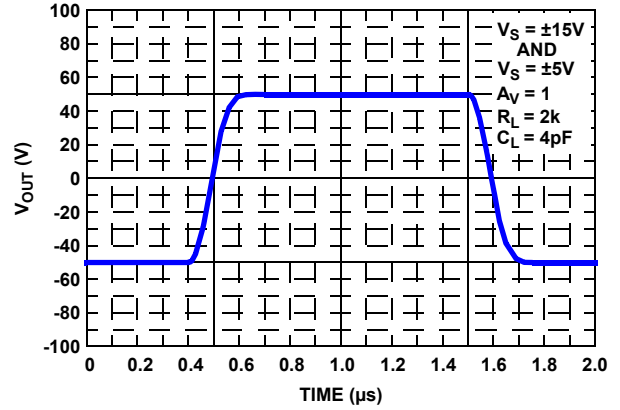

FIGURE 65. SIMULATED SMALL-SIGNAL TRANSIENT RESPONSE

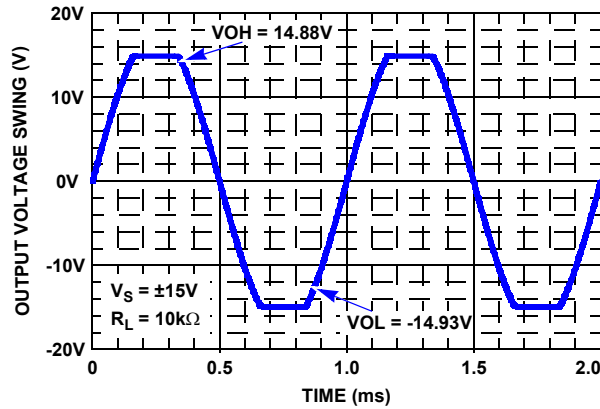

FIGURE 66. SIMULATED OUTPUT VOLTAGE SWING

## Revision History

The revision history provided is for informational purposes only and is believed to be accurate, but not warranted. Please go to web to make sure you have the latest Rev.

DATE	REVISION	CHANGE
March 7, 2014	FN7858.1	Updated Spice model netlist on page 18. Changed POD: FROM M8.118: Corrected lead width dimension in side view 1 from "0.25 - 0.036" to "0.25 - 0.36" To M8.118B: Correct lead dimension in side view 2 from 0.15 - 0.05mm to 0.15+/-0.05mm
May 11, 2011	FN7858.0	Initial Release

## About Intersil

Intersil Corporation is a leading provider of innovative power management and precision analog solutions. The company's products address some of the largest markets within the industrial and infrastructure, mobile computing and high-end consumer markets.

For the most updated datasheet, application notes, related documentation and related parts, please see the respective product information page found at [www.intersil.com](http://www.intersil.com).

You may report errors or suggestions for improving this datasheet by visiting [www.intersil.com/ask](http://www.intersil.com/ask).

Reliability reports are also available from our website at [www.intersil.com/support](http://www.intersil.com/support)

© Copyright Intersil Americas LLC 2011-2014. All Rights Reserved.  
All trademarks and registered trademarks are the property of their respective owners.

For additional products, see [www.intersil.com/en/products.html](http://www.intersil.com/en/products.html)

Intersil products are manufactured, assembled and tested utilizing ISO9001 quality systems as noted in the quality certifications found at [www.intersil.com/en/support/qualandreliability.html](http://www.intersil.com/en/support/qualandreliability.html)

*Intersil products are sold by description only. Intersil may modify the circuit design and/or specifications of products at any time without notice, provided that such modification does not, in Intersil's sole judgment, affect the form, fit or function of the product. Accordingly, the reader is cautioned to verify that datasheets are current before placing orders. Information furnished by Intersil is believed to be accurate and reliable. However, no responsibility is assumed by Intersil or its subsidiaries for its use; nor for any infringements of patents or other rights of third parties which may result from its use. No license is granted by implication or otherwise under any patent or patent rights of Intersil or its subsidiaries.*

For information regarding Intersil Corporation and its products, see [www.intersil.com](http://www.intersil.com)

# Package Outline Drawing M8.118B

8 LEAD MINI SMALL OUTLINE PLASTIC PACKAGE  
Rev 1, 3/12

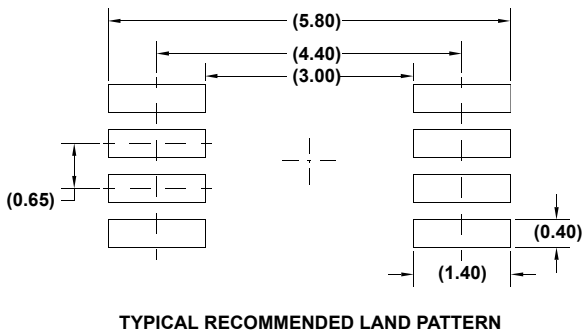
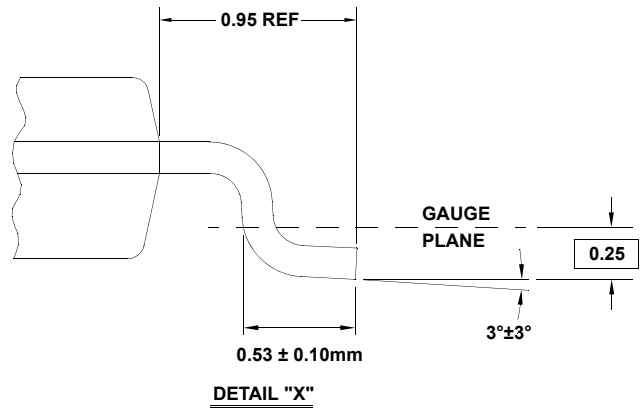
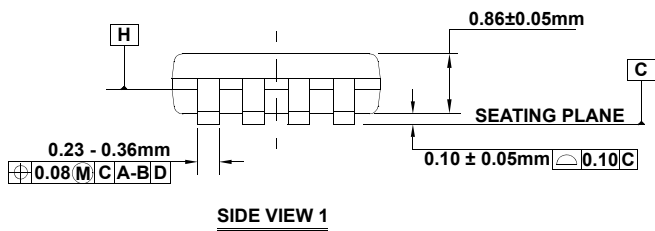
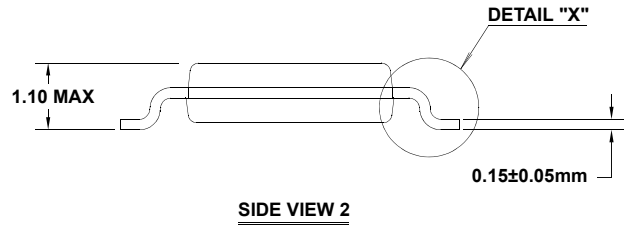
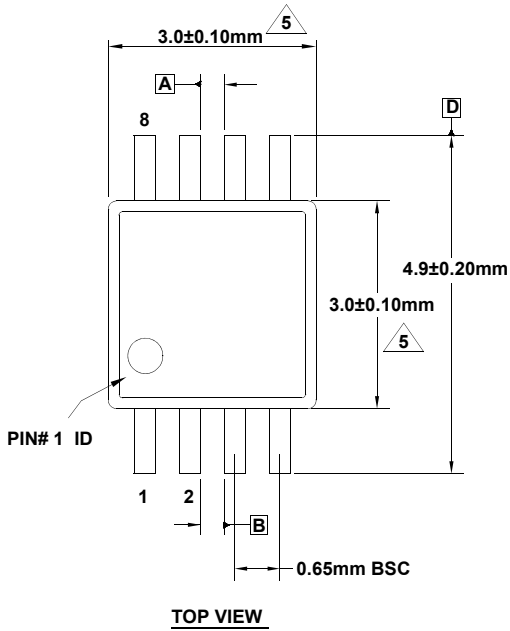

**NOTES:**

1. Dimensions are in millimeters.
2. Dimensioning and tolerancing conform to JEDEC MO-187-AA and AMSEY14.5m-1994.
3. Plastic or metal protrusions of 0.15mm max per side are not included.
4. Plastic interlead protrusions of 0.15mm max per side are not included.
5. Dimensions are measured at Datum Plane "H".
6. Dimensions in ( ) are for reference only.

# Mouser Electronics

Authorized Distributor

Click to View Pricing, Inventory, Delivery & Lifecycle Information:

[Renesas Electronics:](#)

[ISL28118MUZ-T7A](#) [ISL28118MUZ-T7](#) [ISL28118MUZ](#) [ISL28118MUZ-T13](#)