

800MHz BAND FRONT-END GaAs MMIC

■GENERAL DESCRIPTION

NJG1711KC1 is a front-end GaAs MMIC including a LNA, a local amplifier and a mixer, designed mainly for 800MHz band cellular phone handsets.

The ultra small & ultra thin FLP10-C1 package is applied.

■PACKAGE OUTLINE

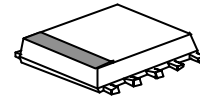

NJG1711KC1

■FEATURES

- Low Voltage Operation +2.8V typ.
- Low Current Consumption
 - LNA 2.8mA typ.
 - Mixer 6.0mA typ. (with local amplifier operation current)
- Ultra Small & Ultra Thin package FLP10-C1 (Mount Size: 2.8x3.0x0.75mm)
- LNA
 - High Small Signal Gain 18.0dB typ. @ $f_{RF}=820\text{MHz}$
 - Low Noise Figure 1.3dB typ. @ $f_{RF}=820\text{MHz}$
 - High Input IP3 -5.0dBm typ. @ $f_{RF}=820+820.1\text{MHz}$
- Mixer
 - High Conversion Gain 12.0dB typ. @ $f_{RF}=820\text{MHz}$, $f_{LO}=706.2\text{MHz}$, $P_{LO}=-10\text{dBm}$
 - Low Noise Figure 5.0dB typ. @ $f_{RF}=820\text{MHz}$, $f_{LO}=706.2\text{MHz}$, $P_{LO}=-10\text{dBm}$
 - High Input IP3 +2.0dBm typ. @ $f_{RF}=820+820.1\text{MHz}$, $f_{LO}=706.2\text{MHz}$, $P_{LO}=-10\text{dBm}$

■PIN CONFIGURATION

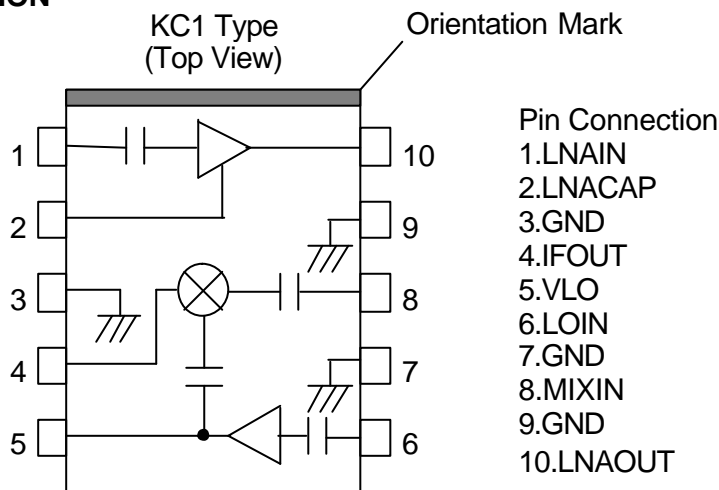

NOTE: Please note that any information on this catalog will be subject to change.

NJG1711KC1

■ABSOLUTE MAXIMUM RATINGS

($T_a=+25^{\circ}\text{C}$, $Z_s=Z_i=50\Omega$)

PARAMETER	SYMBOL	CONDITIONS	RATINGS	UNITS
LNA Voltage	V_{LNA}		5.0	V
Mixer Voltage	V_{MIX}		5.0	V
LOCAL Amplifier Voltage	V_{LO}		5.0	V
Input Power 1	P_{LNAIN}	$V_{LNA}=V_{MIX}=V_{LO}=2.8\text{V}$	+15	dBm
Input Power 2	P_{LOIN}	$V_{LNA}=V_{MIX}=V_{LO}=2.8\text{V}$	+10	dBm
Power Dissipation	P_D		550	mW
Operating Temperature	T_{opr}		-40~+85	$^{\circ}\text{C}$
Storage Temperature	T_{stg}		-55~+125	$^{\circ}\text{C}$

■ELECTRICAL CHARACTERISTICS 1 (LNA)

GENERAL CONDITIONS: $T_a=+25^{\circ}\text{C}$, $V_{LNA}=2.8\text{V}$, $V_{MIX}=V_{LO}=0\text{V}$, $f_{RF}=820\text{MHz}$,
 $P_{RF}=-35\text{dBm}$, $Z_s=Z_i=50\Omega$, with test circuit

PARAMETER	SYMBOL	CONDITIONS	MIN	TYP	MAX	UNITS
Operating Frequency	freq		810	820	885	MHz
LNA Voltage	V_{LNA}		2.5	2.8	4.5	V
LNA Operating Current	I_{LNA}	P_{RF} , $P_{LO}=\text{OFF}$	-	2.8	3.3	mA
Small Signal Gain	Gain		16.0	18.0	19.0	dB
Gain Flatness	G_{flat}	$f_{RF}=810\sim 885\text{MHz}$	-	0.5	1.0	dB
Noise Figure	NF		-	1.3	1.5	dB
Pout at 1dB Gain Compression point	P_{-1dB}		-6.0	+1.0	-	dBm
Input 3rd Order Intercept point	IIP3	$f_{RF}=820.0+820.1\text{MHz}$	-11.0	-5.0	-	dBm
RF IN VSWR	$VSWR_i$		-	1.5	2.0	
RF OUT VSWR	$VSWR_o$		-	1.5	2.0	

■ELECTRICAL CHARACTERISTICS 2 (Mixer)

GENERAL CONDITIONS: $T_a=+25^{\circ}\text{C}$, $V_{LNA}=0\text{V}$, $V_{MIX}=V_{LO}=2.8\text{V}$, $f_{RF}=820\text{MHz}$, $f_{LO}=706.2\text{MHz}$,
 $f_{IF}=113.8\text{MHz}$, $P_{RF}=-30\text{dBm}$, $P_{LO}=-10\text{dBm}$, $Z_s=Z_i=50\Omega$, with test circuit

PARAMETER	SYMBOL	CONDITIONS	MIN	TYP	MAX	UNITS
Operating Frequency	freq		810	820	885	MHz
Mixer Voltage	V_{MIX}		2.5	2.8	4.5	V
Local Amplifier Voltage	V_{LO}		2.5	2.8	4.5	V
Mixer Operating Current	I_{MIX}	P_{RF} , $P_{LO}=\text{OFF}$	-	5.0	6.0	mA
Local Amplifier Operating Current	I_{LO}	P_{RF} , $P_{LO}=\text{OFF}$	-	1.0	1.2	mA
Conversion Gain	G_c		10.5	12.0	-	dB
Noise Figure	NF		-	5.0	6.0	dB
Input 3rd Order Intercept Point	IIP3	$f_{RF}=820.0+820.1\text{MHz}$	-	+2.0	-	dBm

■TERMINAL INFORMATION

No.	SYMBOL	FUNCTION
1	LNAIN	RF input terminal of LNA. An external matching circuit is required.
2	LNACAP	Terminal for the bypass capacitor of LNA. The bypass capacitor C1 as shown in test circuits, should be connected to this terminal as close as possible.
3	GND	Ground terminal (0V)
4	IFOUT	IF signal output terminal. The IF signal is output through external matching circuit connected to this terminal. Please connect inductances L6, L7 and power supply as shown in test circuits, since this terminal is also the terminal of mixer power supply.
5	VLO	Power supply terminal for local amplifier. Please place R1 and L9 as shown in test circuits at very close to this terminal.
6	LOIN	Local signal input terminal to local amplifier. An external matching circuit is required.
7	GND	Ground terminal (0V)
8	MIXIN	RF signal input terminal to mixer. An external matching circuit is required.
9	GND	Ground terminal (0V)
10	LNAOUT	Signal output terminal of LNA. The RF signal from LNA is output through external matching circuit connected to this terminal. Please connect inductances L2, L3 and power supply as shown in test circuits, since this terminal is also the terminal of LNA power supply.

CAUTION

- 1) Ground terminal (No.3, 7, 9) should be connected to the ground plane as low inductance as possible.

NJG1711KC1

■ TYPICAL CHARACTERISTICS (LNA, $f_{LO}=706.2\text{MHz}$, with test circuit)

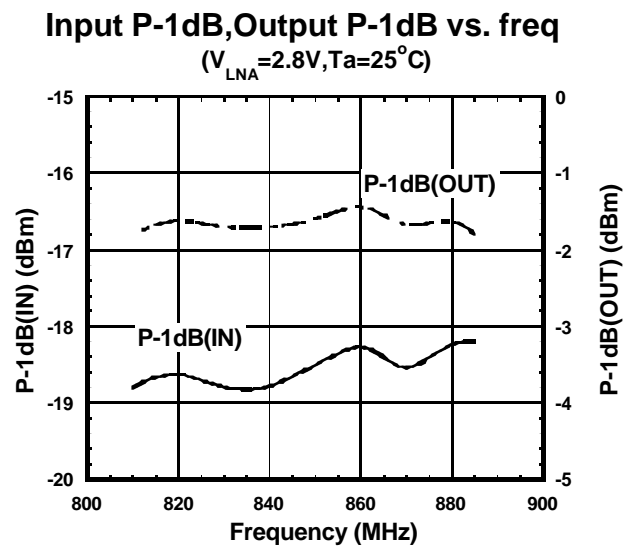
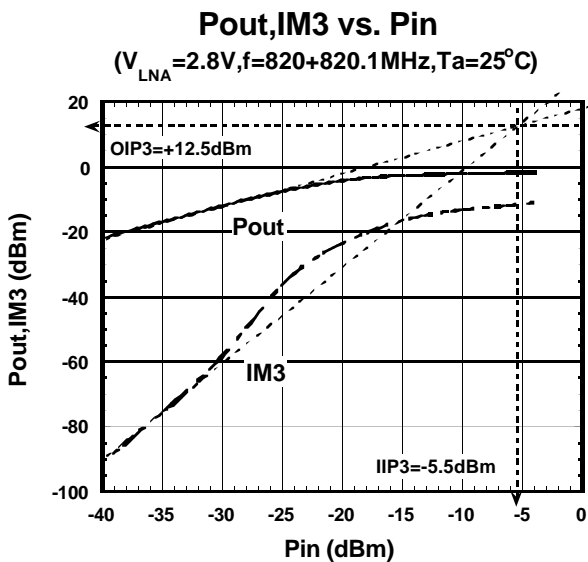
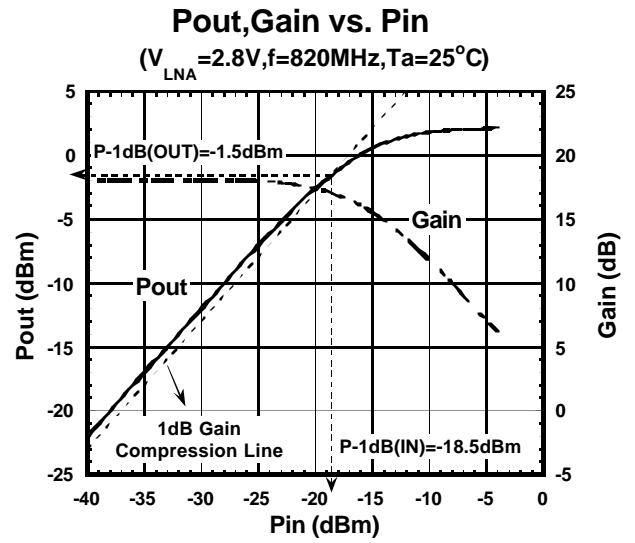
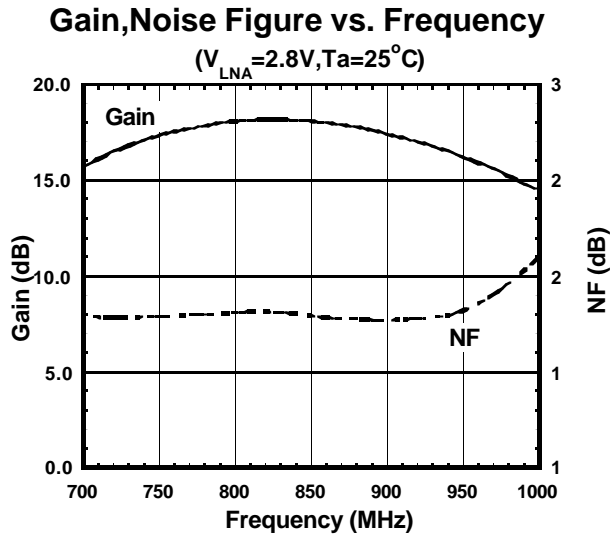

■ TYPICAL CHARACTERISTICS (LNA, $f_{LO}=706.2\text{MHz}$, with test circuit)

OIP3, IIP3 vs. Frequency

($V_{LNA}=2.8\text{V}, T_a=25^\circ\text{C}$)

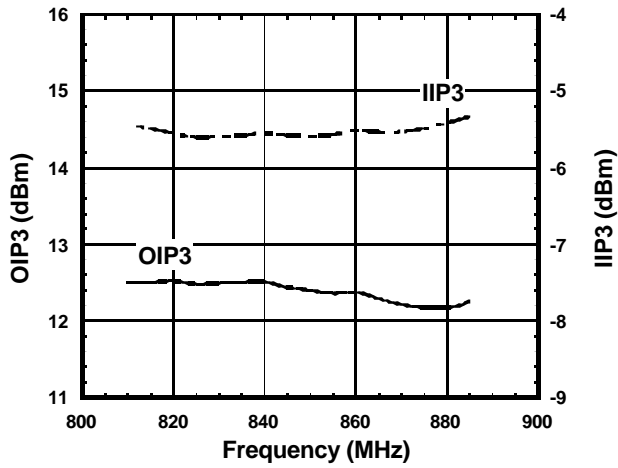

Gain, Noise Figure vs. V_{LNA}
($f=820\text{MHz}, T_a=25^\circ\text{C}$)

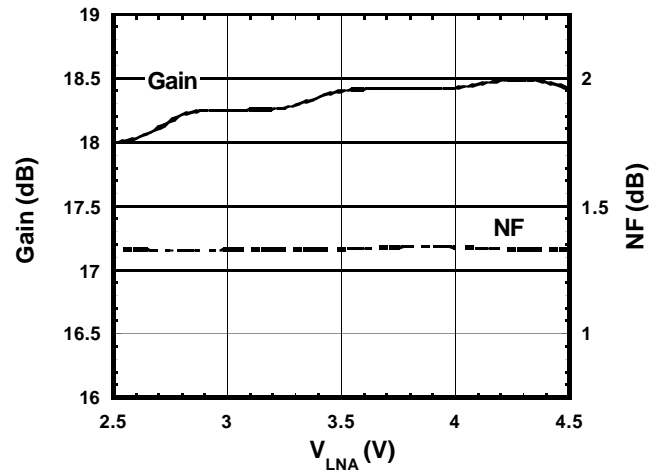

I_{LNA} vs. V_{LNA}

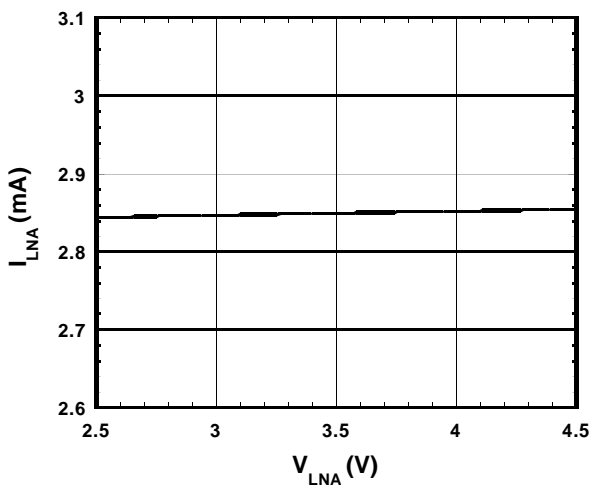

P-1dB vs. V_{LNA}
($f=820\text{MHz}, T_a=25^\circ\text{C}$)

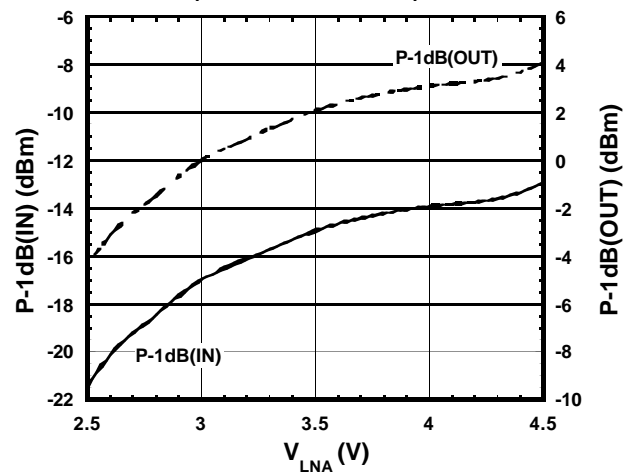

Condition

$V_{LNA}=2.8\text{V}$

$V_{MIX}=V_{LO}=0\text{V}$

The value of OIP3 and IIP3 shown in typical characteristics are calculated by

$$\text{OIP3} = \frac{3 \times \text{Pout} - \text{IM3}}{2}$$

$$\text{IIP3} = \text{OIP3} - \text{Gain} \quad @ \text{Pin} = -35\text{dBm}$$

NJG1711KC1

■ TYPICAL CHARACTERISTICS (LNA, $f_{LO}=706.2\text{MHz}$, with test circuit)

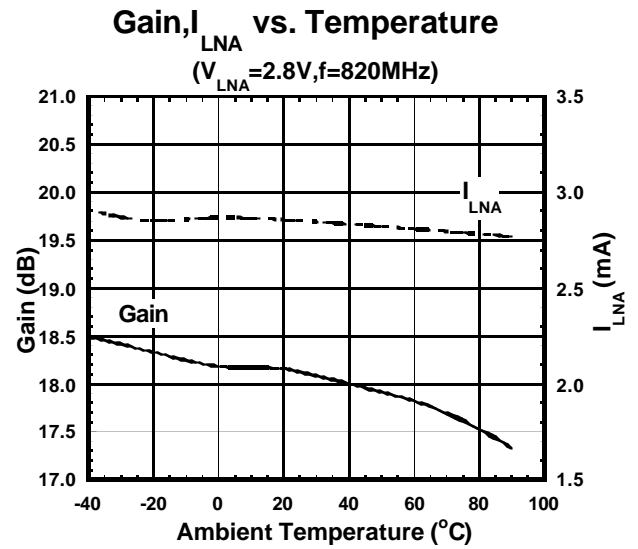
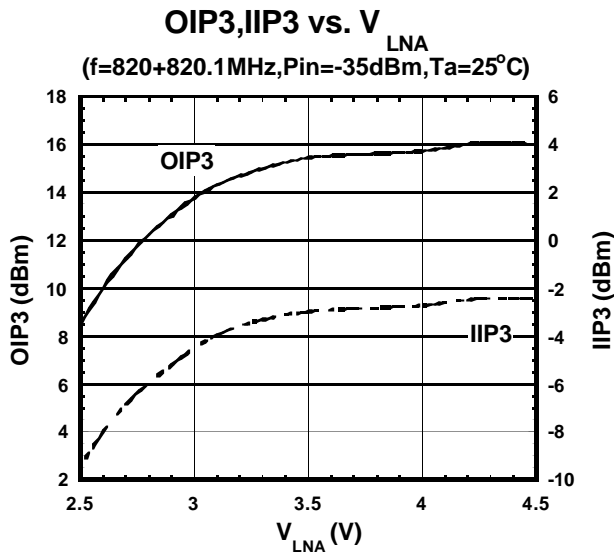

Noise Figure, P-1dB(OUT) vs. Temperature

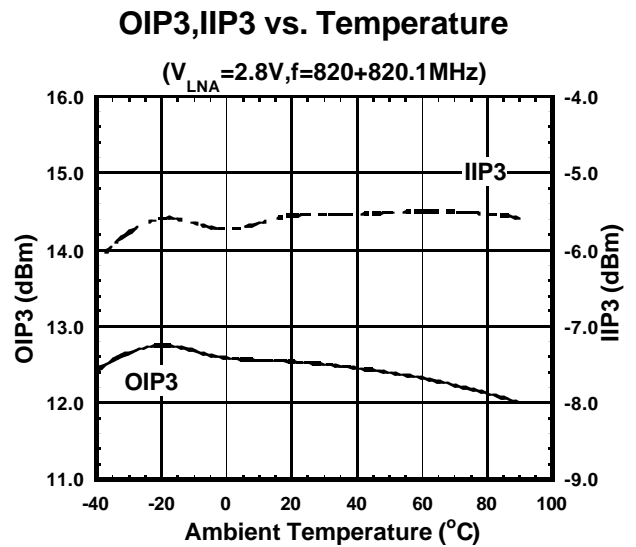
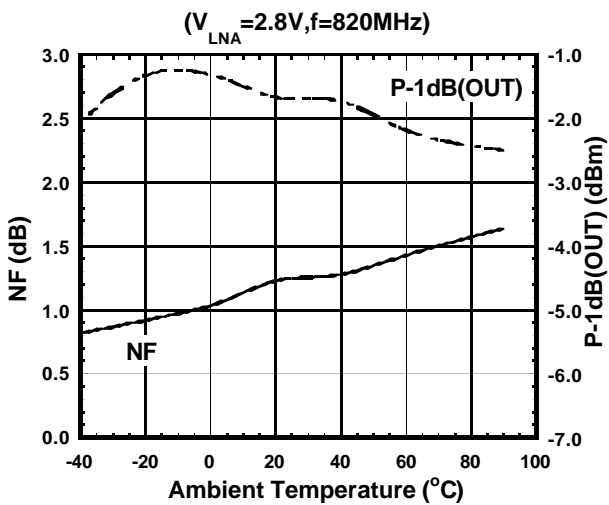

Condition

$$V_{LNA}=2.8\text{V}$$

$$V_{MIX}=V_{LO}=0\text{V}$$

The value of OIP3 and IIP3 shown in typical characteristics are calculated by

$$OIP3 = \frac{3 \times P_{out} - IM3}{2}$$

$$IIP3 = OIP3 - \text{Gain} \quad @ \text{Pin} = -35\text{dBm}$$

■ TYPICAL CHARACTERISTICS (LNA, $f_{LO}=706.2\text{MHz}$, with test circuit)

S11, S22

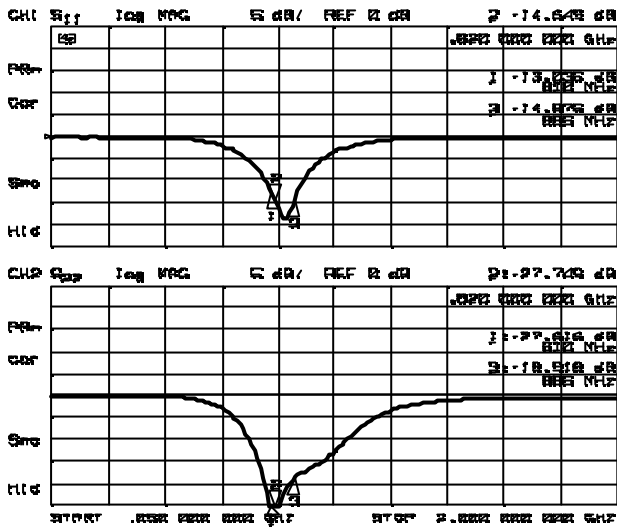

Zin, Zout

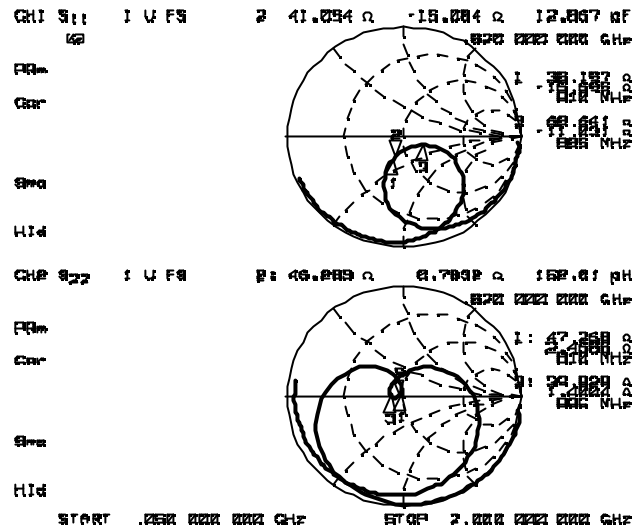

S21

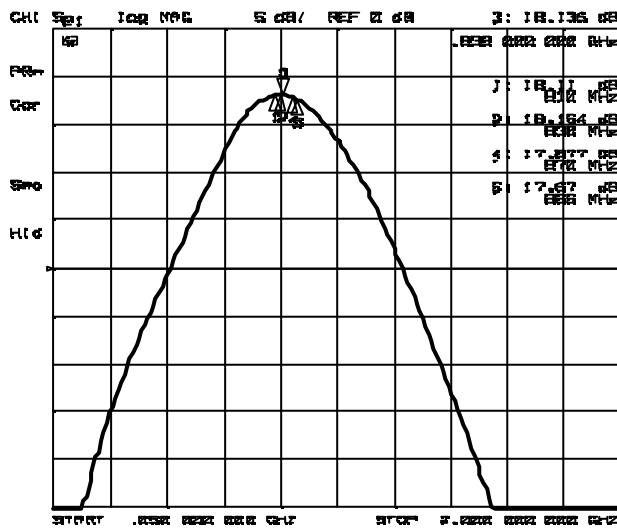

S12

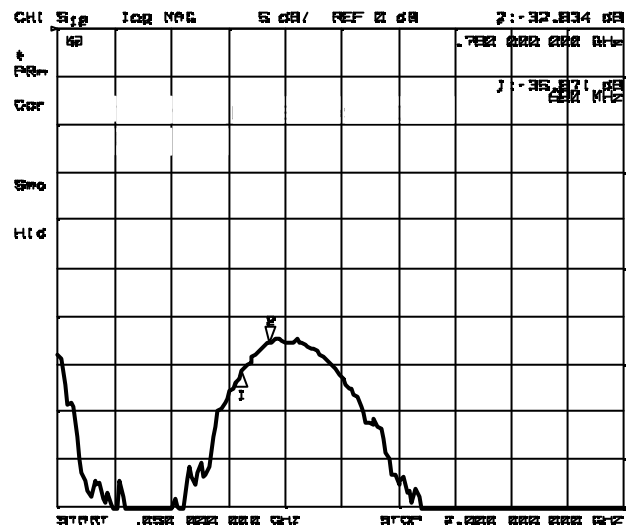

NJG1711KC1

TYPICAL CHARACTERISTICS (MIXER, $f_{LO}=706.2\text{MHz}$, with test circuit)

Conversion Gain, Noise Figure vs. RF Frequency

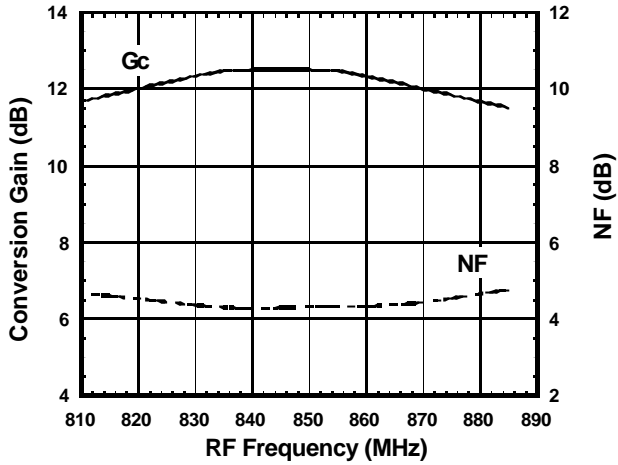

Condition
 $f_{IF}=113.8\text{MHz}$
 $P_{RF}=-30\text{dBm}$
 $P_{LO}=-10\text{dBm}$
 $V_{MIX}=V_{LO}=2.8\text{V}$
 Lower LOCAL

Conversion Gain Noise Figure vs. LO Power

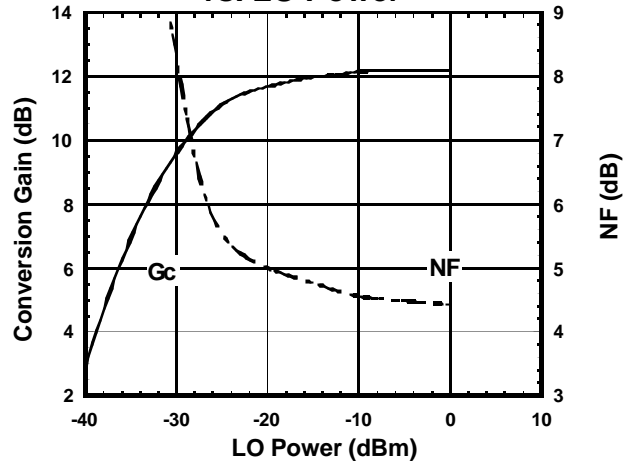

Condition
 $f_{IF}=113.8\text{MHz}$
 $f_{RF}=820\text{MHz}$, $P_{RF}=-30\text{dBm}$
 $f_{LO}=706.2\text{MHz}$
 $V_{MIX}=V_{LO}=2.8\text{V}$

OIP3, IIP3 vs. RF Frequency

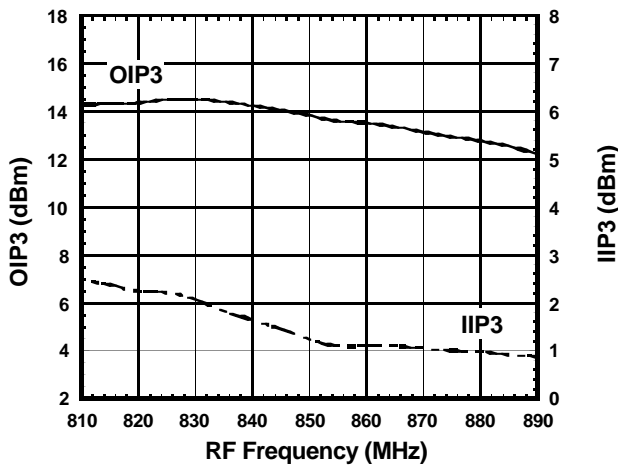

Condition
 $f_{IF}=113.8\text{MHz}$
 $P_{RF}=-30\text{dBm}$
 $P_{LO}=-10\text{dBm}$
 $V_{MIX}=V_{LO}=2.8\text{V}$
 $OIP3 = \frac{3 \times IIP3 - IM3}{2}$
 $IIP3 = OIP3 - Gc$
 @ $P_{RF} = -30\text{dBm}$

OIP3, IIP3 vs. LO Power

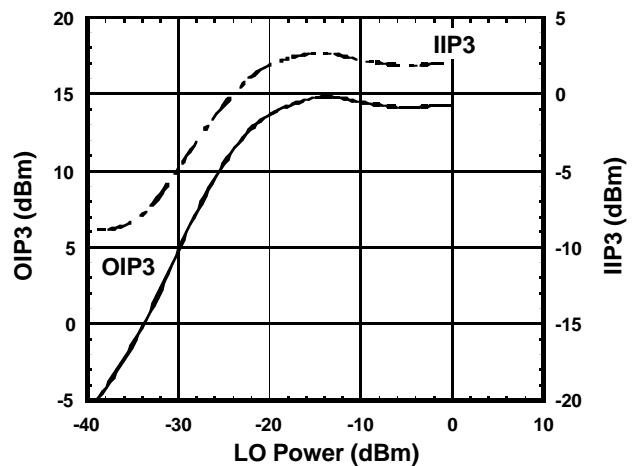

Condition
 $f_{IF}=113.8\text{MHz}$
 $f_{RF1}=820.0\text{MHz}$, $P_{RF}=-30\text{dBm}$
 $f_{RF2}=820.1\text{MHz}$
 $f_{LO}=706.2\text{MHz}$
 $V_{MIX}=V_{LO}=2.8\text{V}$
 $OIP3 = \frac{3 \times IIP3 - IM3}{2}$
 $IIP3 = OIP3 - Gc$
 @ $P_{RF} = -30\text{dBm}$

■ TYPICAL CHARACTERISTICS (MIXER, $f_{LO}=706.2\text{MHz}$, with test circuit)

Conversion Gain, Noise Figure

vs. V_{MIX}, V_{LO}

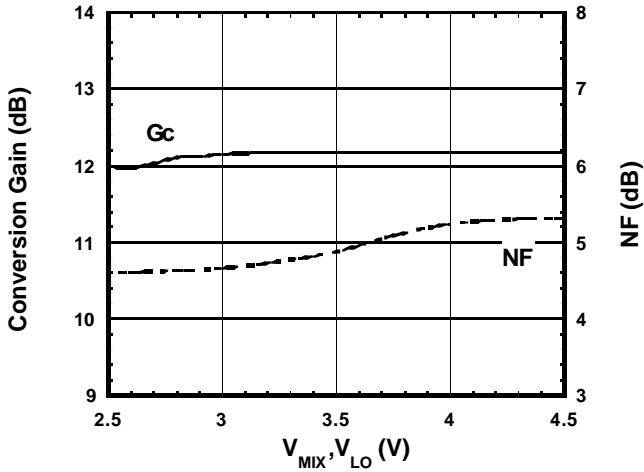

Condition

$f_{IF}=113.8\text{MHz}$
 $f_{RF}=820\text{MHz}$, $P_{RF}=-30\text{dBm}$
 $f_{LO}=706.2\text{MHz}$, $P_{LO}=-10\text{dBm}$

IIP3, OIP3 vs. V_{MIX}, V_{LO}

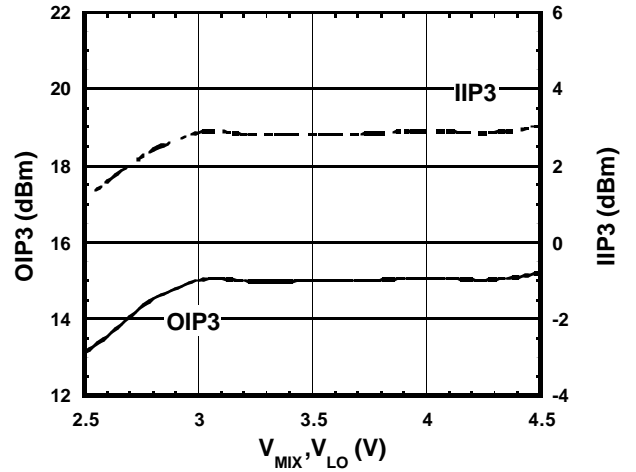

Condition

$f_{IF}=113.8\text{MHz}$
 $f_{RF1}=820.0\text{MHz}$, $P_{RF}=-30\text{dBm}$
 $f_{RF2}=820.1\text{MHz}$
 $f_{LO}=706.2\text{MHz}$, $P_{LO}=-10\text{dBm}$

$$OIP3 = \frac{3 \times IF - IM3}{2}$$

$$IIP3 = OIP3 - Gc$$

 @ $P_{RF} = -30\text{dBm}$

IF Output Power vs. RF Power

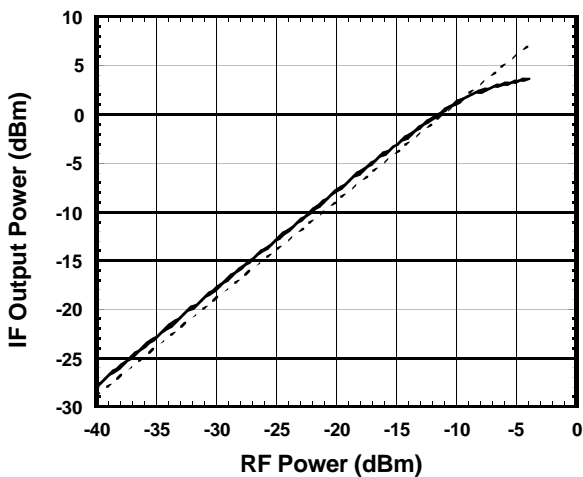

Condition

$f_{IF}=113.8\text{MHz}$
 $f_{RF}=820\text{MHz}$
 $f_{LO}=706.2\text{MHz}$, $P_{LO}=-10\text{dBm}$
 $V_{MIX}=V_{LO}=2.8\text{V}$

NJG1711KC1

■ TYPICAL CHARACTERISTICS (MIXER, $f_{LO}=706.2\text{MHz}$, with test circuit)

**Conversion Gain vs. RF Frequency
Temperature Response**

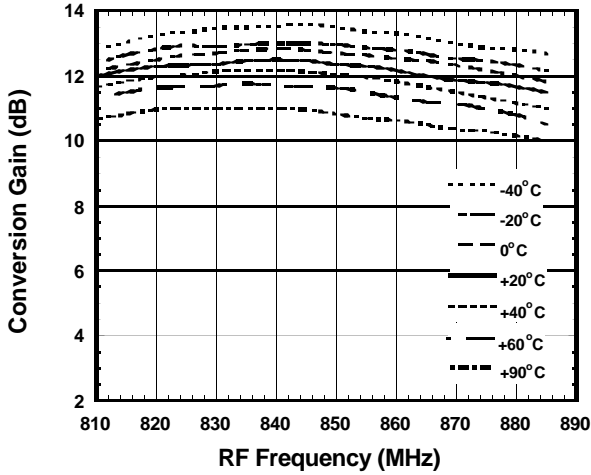

Condition
 $f_{IF}=113.8\text{MHz}$
 $P_{RF}=-30\text{dBm}$
 $P_{LO}=-10\text{dBm}$
 $V_{MIX}=V_{LO}=2.8\text{V}$

**Conversion Gain vs. Local Power
Temperature Response**

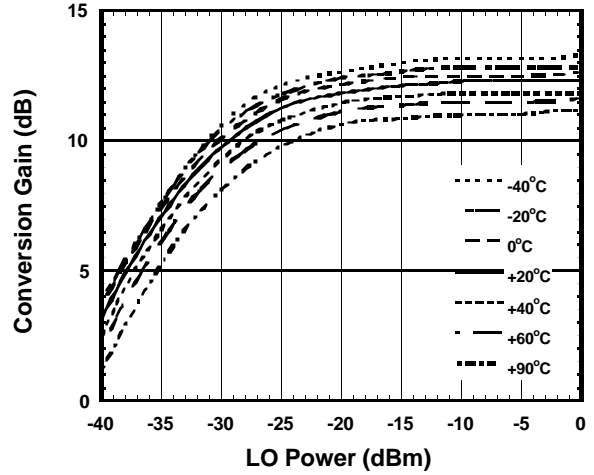

Condition
 $f_{IF}=113.8\text{MHz}$
 $f_{RF}=820\text{MHz}$, $P_{RF}=-30\text{dBm}$
 $f_{LO}=706.2\text{MHz}$
 $V_{MIX}=V_{LO}=2.8\text{V}$

**Noise Figure vs. Local Power
Temperature Response**

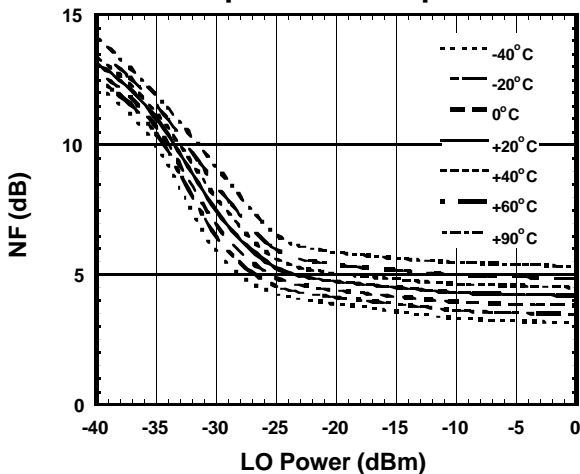

Condition
 $f_{IF}=113.8\text{MHz}$
 $f_{RF}=820\text{MHz}$, $P_{RF}=-30\text{dBm}$
 $f_{LO}=706.2\text{MHz}$
 $V_{MIX}=V_{LO}=2.8\text{V}$

**IIP3 vs. Local Power
Temperature Response**

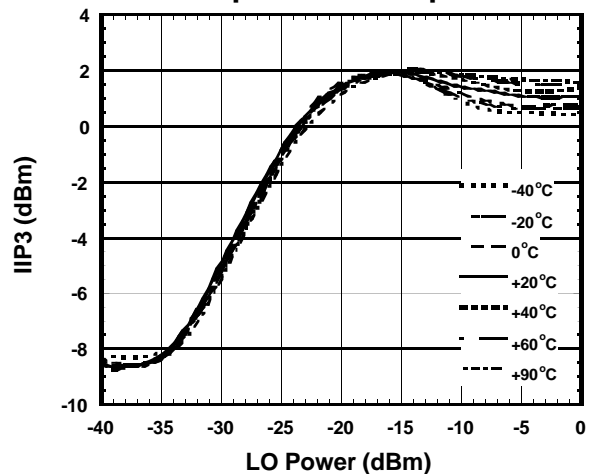

Condition
 $f_{IF}=113.8\text{MHz}$
 $f_{RF1}=820.0\text{MHz}$, $P_{RF}=-30\text{dBm}$
 $f_{RF2}=820.1\text{MHz}$
 $f_{LO}=706.2\text{MHz}$
 $V_{MIX}=V_{LO}=2.8\text{V}$

$$IIP3 = \frac{3 \times I_F - IM3}{2} - G_c$$

@ $P_{RF} = -30\text{dBm}$

■ TYPICAL CHARACTERISTICS (MIXER, $f_{LO}=706.2\text{MHz}$, with test circuit)

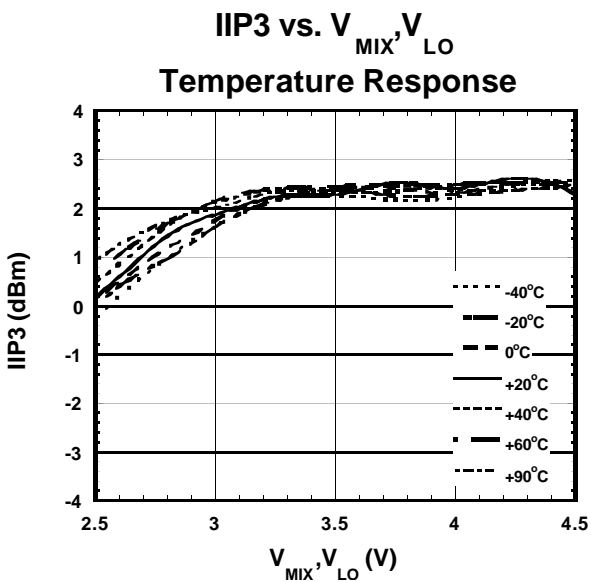
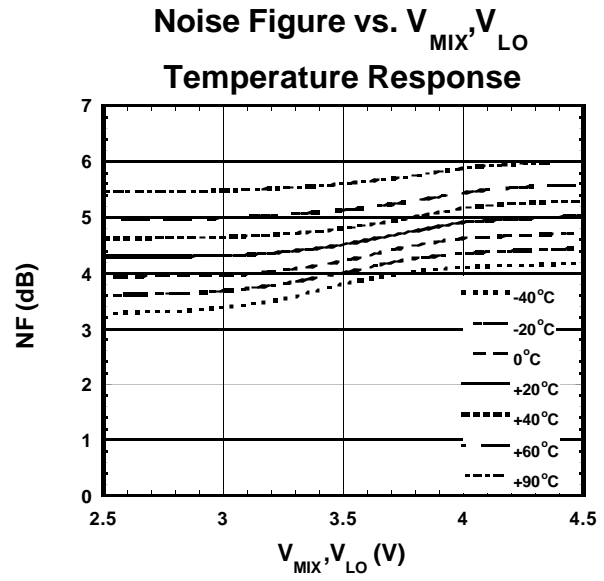
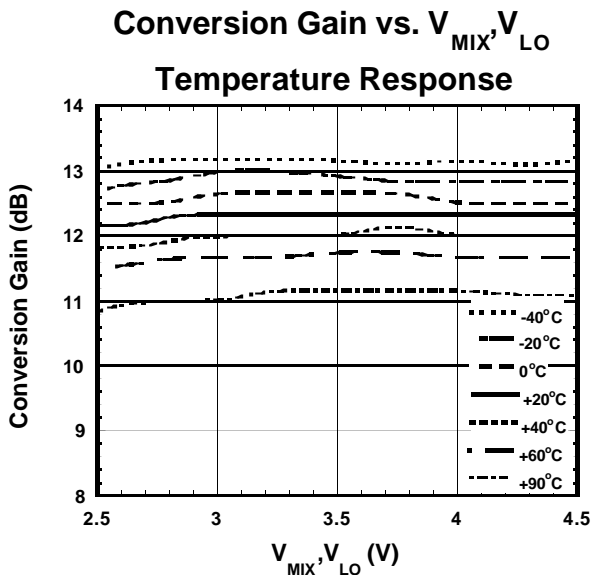

$$IIP3 = \frac{3 \times I_{F-IM3}}{2} - G_c$$

@ $P_{RF} = -30\text{dBm}$

NJG1711KC1

TYPICAL CHARACTERISTICS (MIXER, $f_{LO}=706.2\text{MHz}$, with test circuit)

MIXER IN PORT IMPEDANCE

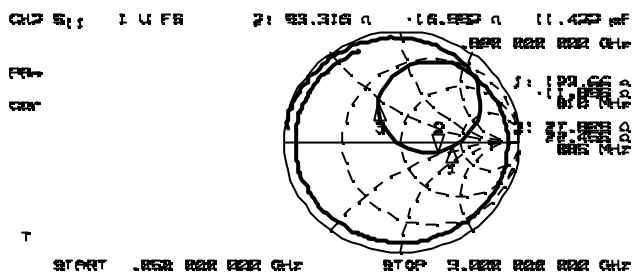
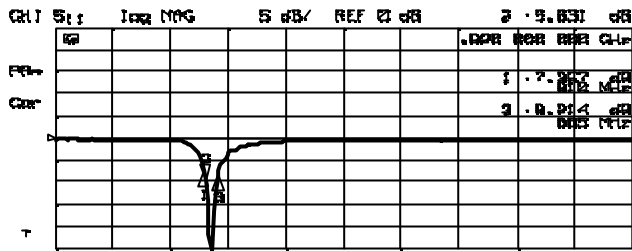

Condition
 $V_{LNA}=0V$
 $V_{MIX}=V_{LO}=2.8V$

LOCAL IN PORT IMPEDANCE

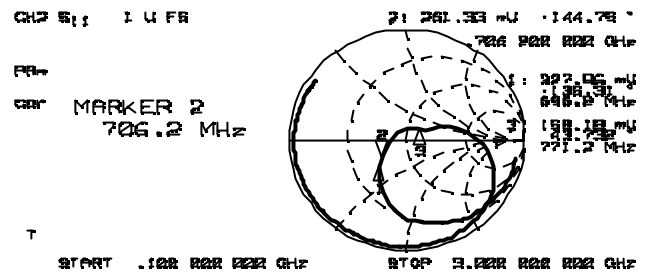
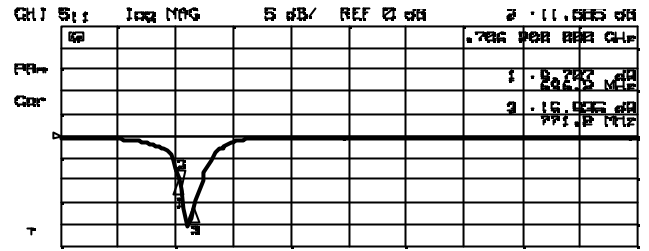

Condition
 $V_{LNA}=0V$
 $V_{MIX}=V_{LO}=2.8V$

IF OUT PORT IMPEDANCE

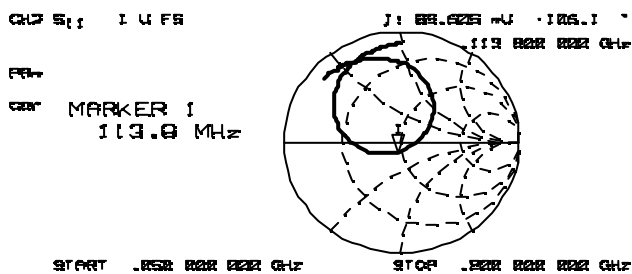
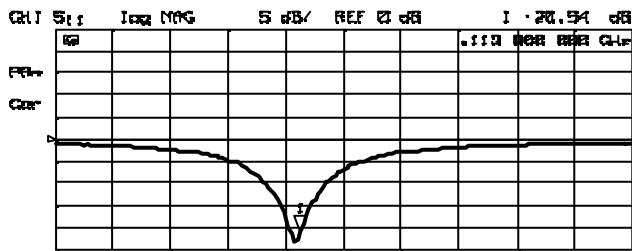

Condition
 $V_{LNA}=0V$
 $V_{MIX}=V_{LO}=2.8V$

TEST CIRCUIT

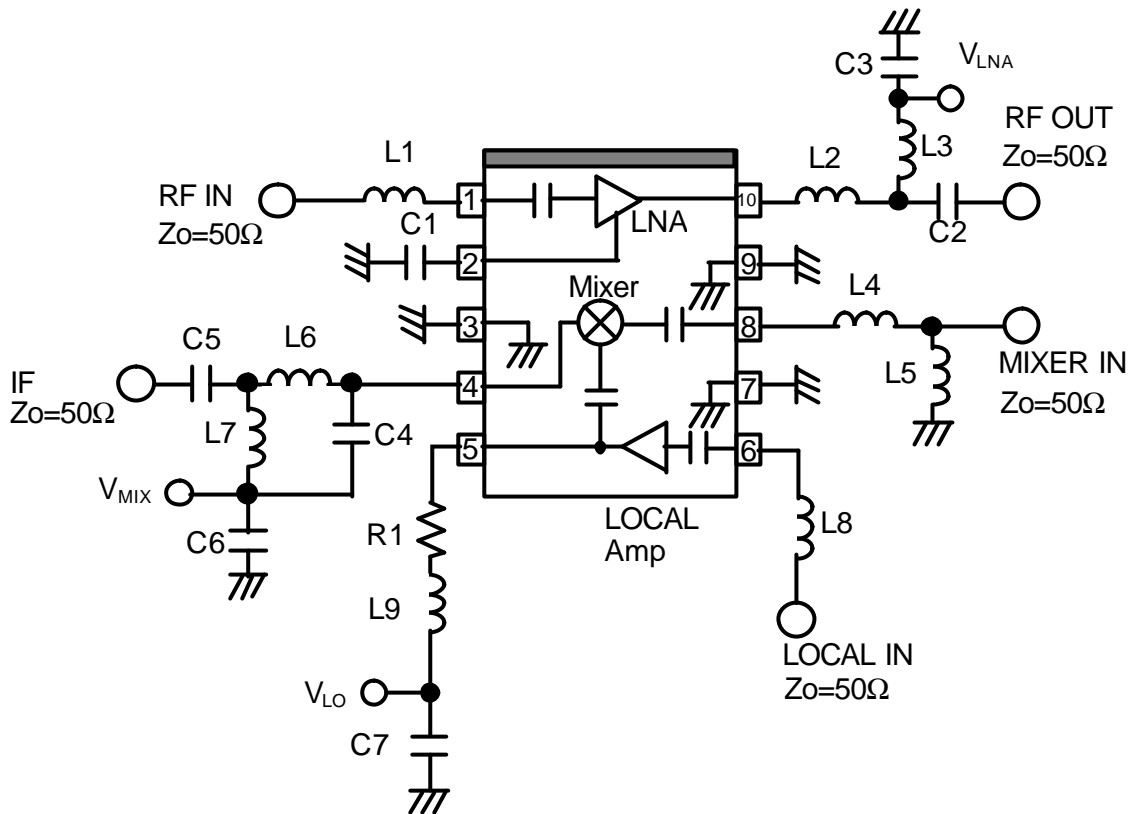

PARTS LIST

PART ID	800MHz BAND		COMMENT
	Lower LOCAL		
	$f_{LO}=706.2\text{MHz}$ $f_{IF}=113.8\text{MHz}$		
L1	33nH		TAIYO-YUDEN (HK1005)
L2	39nH		TAIYO-YUDEN (HK1005)
L3	12nH		TAIYO-YUDEN (HK1005)
L4	15nH		PANASONIC [MEC] (ELJRF)
L5	4.7nH		PANASONIC [MEC] (ELJRF)
L6	120nH		TAIYO-YUDEN (HK1005)
L7	56nH		TAIYO-YUDEN (HK1005)
L8	39nH		TAIYO-YUDEN (HK1005)
L9	39nH		TAIYO-YUDEN (HK1005)
C1	1000pF		MURATA (GRM36)
C2	3pF		MURATA (GRM36)
C3	1000pF		MURATA (GRM36)
C4	11pF		MURATA (GRM36)
C5	1000pF		MURATA (GRM36)
C6	0.1uF		MURATA (GRM36)
C7	0.1uF		MURATA (GRM36)
R1	33Ω		1005 Size

(Note) Please use 1608 type inductor to improve NF characteristics.

NJG1711KC1

RECOMMENDED PCB DESIGN

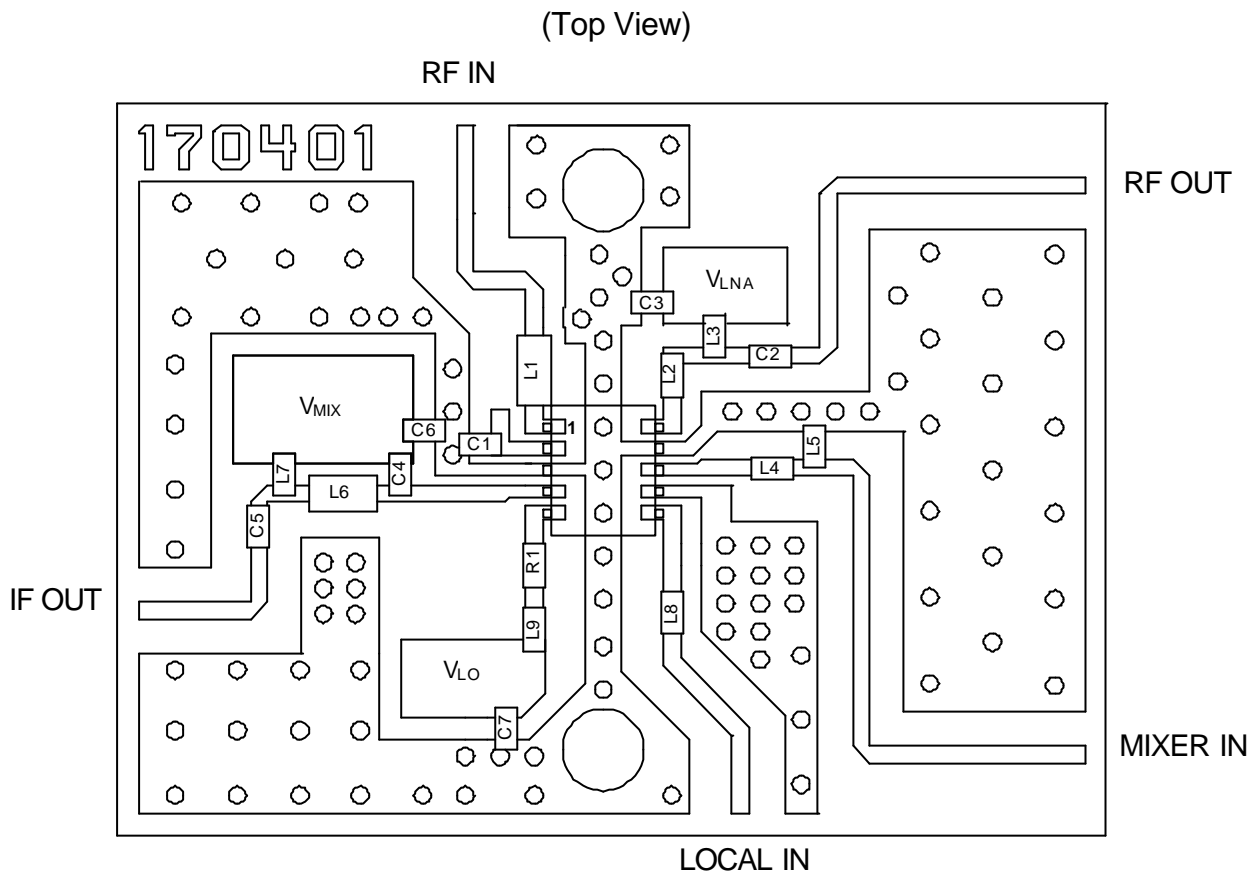

PCB (FR-4): t=0.2mm

MICROSTRIP LINE WIDTH=0.4mm ($Z_0=50\Omega$)

PCB SIZE =23.0x17.0mm

Caution on using devices.

- [1] Please place R1 close to the VLO terminal (5th pin), and L9 to R1.
- [2] Please place C1 close to the LNACAP terminal (2nd pin).
- [3] Please place C3 close to L3.
- [4] Please place C6 close to C4.
- [5] Please place C7 close to L9.

MEASURING BLOCK DIAGRAM

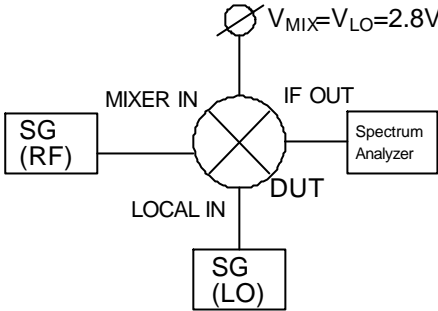

Conversion Gain Measuring Block Diagram

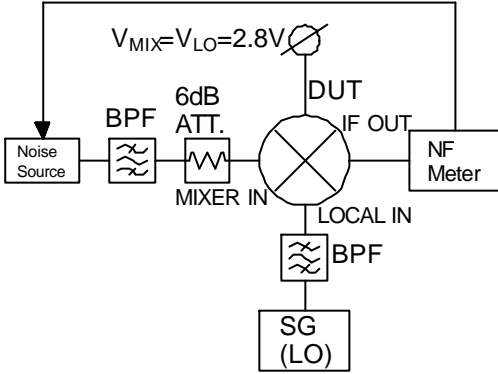

Noise Figure Measuring Block Diagram

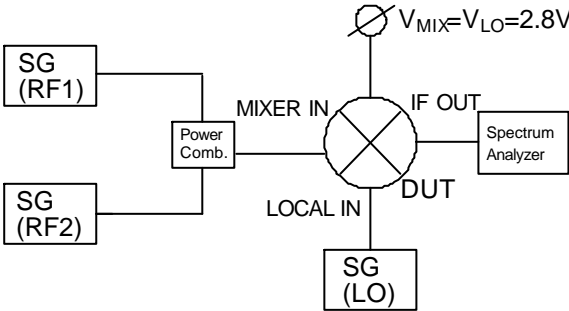

IF, IM3 Measuring Block Diagram

NJG1711KC1

PACKAGE OUTLINE (FLP10-C1)

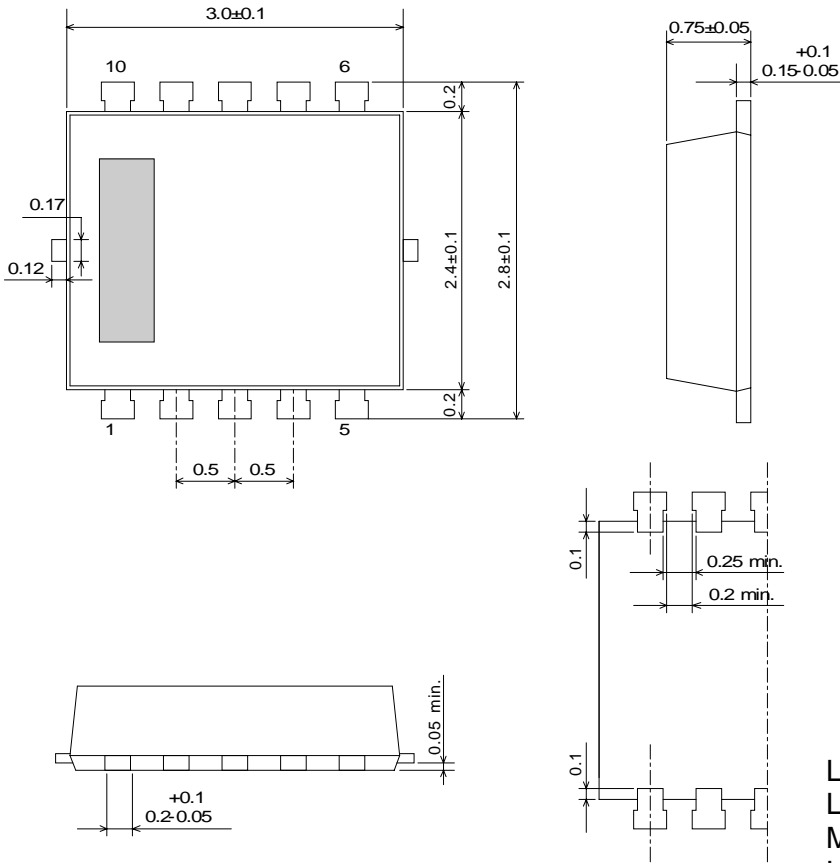

Lead material	: Copper
Lead surface finish	: Solder plating
Molding material	: Epoxy resin
UNIT	: mm
Weight	: 15mg

Cautions on using this product

- This product contains Gallium-Arsenide (GaAs) which is a harmful material.
- Do NOT eat or put into mouth.
 - Do NOT dispose in fire or break up this product.
 - Do NOT chemically make gas or powder with this product.
 - To waste this product, please obey the relating law of your country.

This product may be damaged with electric static discharge (ESD) or spike voltage. Please handle with care to avoid these damages.

[CAUTION]

The specifications on this databook are only given for information, without any guarantee as regards either mistakes or omissions. The application circuits in this databook are described only to show representative usages of the product and not intended for the guarantee or permission of any right including the industrial rights.

Mouser Electronics

Authorized Distributor

Click to View Pricing, Inventory, Delivery & Lifecycle Information:

[NJR:](#)

[NJG1711KC1-TE3](#)