



## Ultra-Fast Fully Insulated FASTON Receptacles and Tabs

### Product Facts

- One-piece Fully Insulated Premier Line FASTON Receptacle crimp helps prevent shock and short hazards
- Designed for correct lead-in of tab
- Designed for full mating with a variety of tab styles including those with shoulders
- Funnel wire entry
- Wire Stop
- Visual inspection of crimp and wire brush
- Assemblies are color-coded by wire size
- Assemblies contain wire size and tab size designation
- Mating tab thickness marked on terminal and visible through housing (.110, .187 and .205 Series)
- Application tooling available to meet production requirements
- Tin plated copper alloy terminals
- UL rated at + 105°C
- Terminates 26-10 AWG solid, fused and stranded wire (Flags terminate stranded wire only)

### Performance Capabilities

- Meets UL-310 specification for quick connect terminals; UL listed under File No. E-66717 
- Meets CSA C22.2, No. 153 specification for quick connect terminals; CSA Certified under File No. LR 7189 
- 600-volt application capability (1,000 volts for signs and fixtures)



The Ultra-Fast Fully Insulated FASTON Receptacle and Tab offers the advantage of a completely protected terminal and a wire crimp with comparable electromechanical performance to open barrel "F" crimp FASTON Terminals. The "User-Friendly" design combines easy mating with rounded corners. The .187 and .250 series receptacles incorporate a two-stage roll configuration and a cantilever mounted dimple which provides easy insertion and multiple independent points of contact for reduced tab interface resistance.

Ultra-Fast Fully Insulated FASTON Receptacles, Flag Receptacles and Tabs preclude the need for costly electrical safety interlocks or special protective shields to help prevent shock hazards. In addition, electrical short circuits from exposed leads are eliminated, even in equipment requiring close contact spacing.

The Ultra-Fast FASTON Receptacle, Flag Receptacle

and Tab are preinsulated assemblies featuring a housing molded from type 6/6 nylon material with a +130°C UL temperature rating.

The Ultra-Fast FASTON Receptacle housing completely encloses a tin plated copper alloy Premier FASTON receptacle which has been stress-relieved for increased durability and resistance to abuse. The FASTON receptacle is recessed sufficiently within the housing to allow its use in 600-volt applications. The receptacle portion of the terminal is designed for positive mating with a variety of tabs, including those with shoulders. The housing has a slotted membrane which is displaced by two tab shoulders allowing proper engagement of tab and receptacle while maintaining the fully insulated characteristic.

Positive entry and lead-in of the tab is provided by the inner housing wall and the lead-in on the terminal rolls.

This permits positive engagement, even in blind mating locations.

The Ultra-Fast FASTON Tab housing completely encloses a tin plated copper alloy FASTON tab. The FASTON tab is recessed sufficiently within the housing to allow its use in 600-volt applications. The housing is designed to completely encapsulate the tab and receptacle when the two are mated.

Quality control is easily maintained. The nylon housing is translucent, allowing visual inspection of the termination. In addition, a crimp code on the platform hand tool is indented into the housing during the crimping operation which identifies that the proper crimp dies were used.

Depending on production requirements, TE provides a complete selection of terminating equipment from hand tools to automatic lead makers.

**Ultra-Fast Fully Insulated FASTON Receptacles and Tabs** (Continued)

**Test Specifications**

The following information and accompanying graphs are taken from TE Product Qualification Testing of Ultra-Fast FASTON product. Tests were conducted on representative production samples, and all values shown are averages of group results. The values shown are typical results and may vary due to differences in processing, application and methods of testing.

**Current vs. Temperature Rise (16 AWG)**

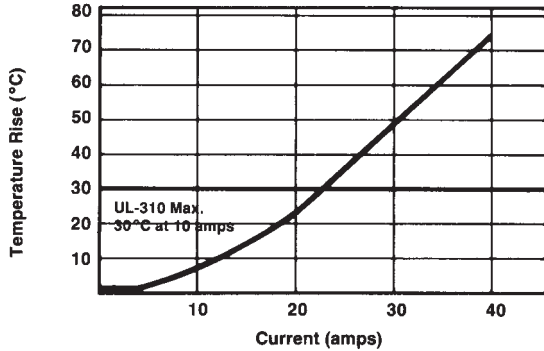

The heat generated by the current passing through a termination is a primary limit to the load-carrying capabilities of the application. A low termination resistance will produce a lower temperature rise as current is applied. In order to evaluate this characteristic, UL has established current ratings for each wire size and set a maximum temperature rise to assure safe operation. For example, 16 AWG stranded wire has a UL 310 maximum temperature rise of 30°C above ambient temperature at the rated current of 10 amps. In the testing of the Ultra-Fast FASTON product applied to 16 AWG wire, the temperature rise was found to be below 10°C at the rated current. In fact, the temperature rise did not exceed 30°C until the current was above 20 amps, more than twice the rated current.

**Current Cycling vs. Temperature Rise (16 AWG)**

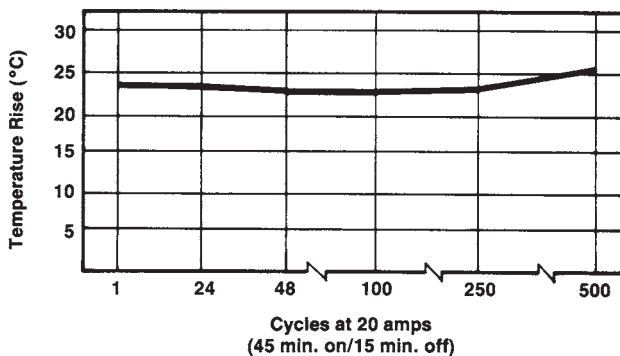

Maintaining a safe temperature rise during cyclic applications of excessive current is the toughest challenge for the crimp-thru-plastic concept. The ability of the Ultra-Fast FASTON product line to meet this goal sets it apart from other preinsulated terminations. TE's experience in crimp development results in a termination that exhibits stable heating characteristics which are well within the safety requirements of the industry.

To test a product, it must be subjected to 500 on and off cycles at twice the rated current for the particular wire size. The temperature rise is measured on the 24th cycle and the 500th cycle. The maximum temperature rise is limited to 85°C above ambient temperature with a maximum of 15°C increase on any sample between the 24th and 500th cycles. Our testing of 16 AWG wire application indicated a 25.5°C maximum temperature rise up to 500 cycles, with a maximum increase of 0.8°C from the 24th to the 500th cycle for one sample in the test group.

**Engagement/Separation**

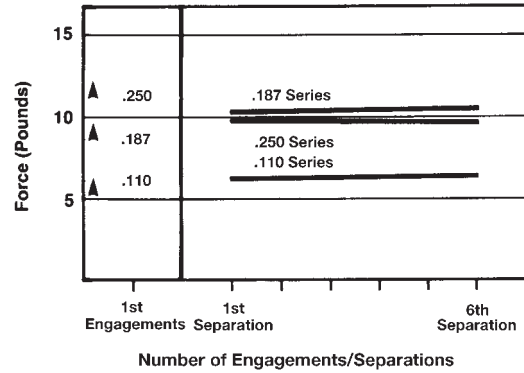

The forces caused by the rolls of FASTON style terminals determine the contact interface integrity of a mated receptacle and tab. These forces must be high enough to prevent oxidation and corrosion from forming inside the contact area. As these forces are raised to increase the electrical performance, the engagement and separation forces for mating the contacts are significantly increased. For this reason, the Premier Low Insertion Force FASTON concept of receptacle design has been carried over to the Ultra-Fast FASTON products. This feature provides consistent engagement and separation forces while maintaining a high standard of electrical reliability.

**Crimp Tensile**

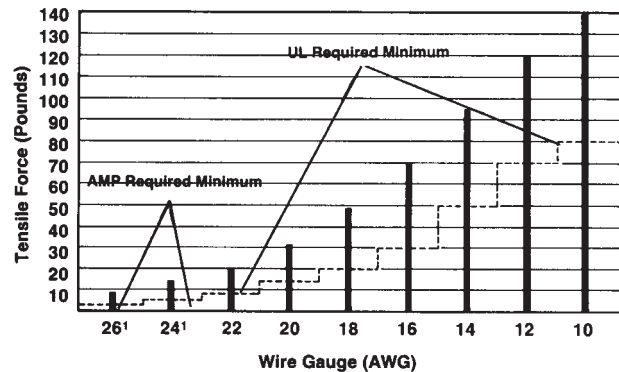

<sup>1</sup> UL does not have requirements for wire gauges below 22 AWG. **Note:** Minimum requirements are per TE specifications.

The crimp tensile strength of a wire-to-terminal connection is important in guarding against such hazards as wire flexing, vibration and wire strain. However, maximum tensile strength does not insure maximum electrical performance. An acceptable compromise between tensile strength and electrical performance must always be reached, using recommended crimp heights.

**Ultra-Fast Fully Insulated FASTON Receptacles and Tabs (Continued)**

**Ultra-Fast Fully Insulated FASTON Receptacles**

**Material**

- Housing** — Nylon Type 6/6
- Flammability** — UL 94 V-2
- Terminal** — Tin plated, copper alloy
- Color Code (Translucent)**
- Violet** — 26-22 AWG
- Red** — 22-18 AWG
- Blue** — 16-14 AWG
- Yellow** — 12-10 AWG

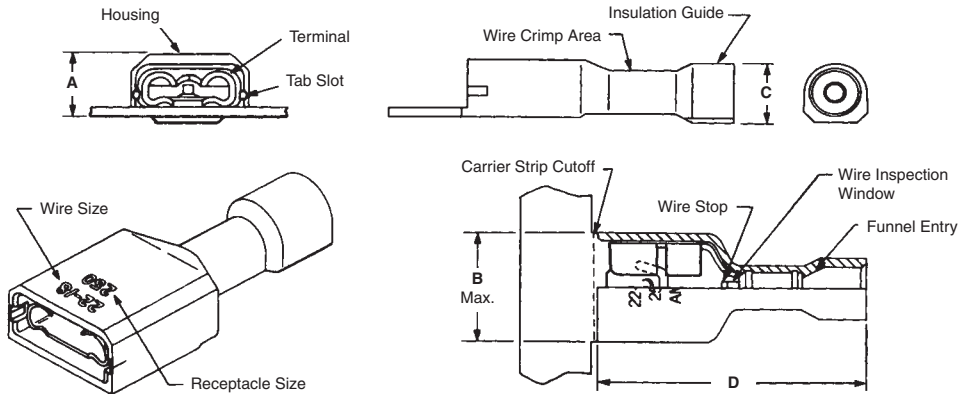

Description	Wire Range AWG	Ins. Dia. Max.	Dimensions				Mating Tab	Terminal Base Material	Part Numbers			
			A	B	C	D			Strip	Loose Piece		
.110/.125 Series	26-22	.100 2.54	.145	.275	.138	.735	.020 x .110/.125 0.51 x 2.79/3.18	Brass	7-520365-2 <sup>1</sup>	7-520366-2 <sup>1</sup>		
			3.68	6.99	3.51	18.67	.016 x .110/.125 0.41 x 2.79/3.18	Brass	2-520080-2 <sup>1</sup>	2-520081-2 <sup>1</sup>		
	22-18	.120 3.05	.160	.275	.167	.735	.020 x .110/.125 0.51 x 2.79/3.18	Brass	2-520083-2	2-520084-2		
				4.06	6.99	4.24	18.67	.032 x .110/.125 0.81 x 2.79/3.18	Brass	2-520272-2 <sup>3</sup>	2-520273-2	
				.230	.155	.275	.295	.865	.020 x .110/.125 0.51 x 2.79/3.18	Brass	2-520306-2	—
				5.84	3.94	6.99	7.49	21.97	.032 x .110/.125 0.81 x 2.79/3.18	Brass	2-520310-2	—
	16-14	.260 6.60	.175	.275	.325	.865	.020 x .110/.125 0.51 x 2.79/3.18	Brass	3-520370-2 <sup>2</sup>	—		
				4.45	6.99	8.26	21.97	.020 x .187 0.51 x 4.75	Brass	2-520181-2 <sup>3</sup>	2-520182-2	
	.187 Series	22-18	.135 3.43	.165	.336	.200	.855	.032 x .187 0.81 x 4.75	Phos. Brz.	2-520181-4	—	
				4.19	8.53	5.08	21.72	.020 x .187 0.51 x 4.75	Brass	2-520193-2 <sup>3</sup>	2-520194-2	
22-18		.230 5.84	.165	.336	.295	.935	.020 x .187 0.51 x 4.75	Brass	2-520261-2 <sup>3</sup>	2-520262-2		
				4.19	8.53	7.49	23.75	.032 x .187 0.81 x 4.75	Brass	2-520274-2	2-520275-2	
16-14		.160 4.06	.185	.336	.225	.855	.020 x .187 0.51 x 4.75	Brass	3-350815-2	3-350816-2		
				4.70	8.53	5.72	21.72	.032 x .187 0.81 x 4.75	Brass	3-520124-2 <sup>3</sup>	3-520125-2	
				.260	.185	.336	.325	.935	.020 x .187 0.51 x 4.75	Brass	3-520150-2	3-520151-2
				6.60	4.70	8.53	8.26	23.75	.032 x .187 0.81 x 4.75	Brass	3-520276-2 <sup>3</sup>	—
.205 Series		22-18	.135 3.43	.195	.409	.200	.855	.020 x .205 0.81 x 5.21	Brass	2-521406-2	—	
				4.95	10.39	5.08	21.72	.032 x .205 0.81 x 5.21	Brass	2-521308-2	—	
	22-18	.135 3.43	.195	.409	.200	.855	.032 x .250 0.81 x 6.35	Brass	2-520183-2 <sup>3</sup>	2-520184-2		
				4.95	10.39	5.08	21.72	Phos. Brz.	2-520183-4	2-520184-4		
	22-18	.230 5.84	.195	.409	.295	.935	.032 x .250 0.81 x 6.35	Brass	2-520263-2	2-520264-2		
				4.95	10.39	7.49	23.75	Phos. Brz.	2-520263-4	—		
.250 Series	16-14	.160 4.06	.195	.409	.225	.855	.032 x .250 0.81 x 6.35	Brass	3-350819-2	3-350820-2		
			4.95	10.39	5.72	21.72	Phos. Brz.	3-520116-2	3-520117-2			
	16-14	.260 6.60	.195	.409	.325	.935	.032 x .250 0.81 x 6.35	Brass	3-520140-2	3-520141-2		
				4.95	10.39	8.26	23.75	Phos. Brz.	3-520140-4	—		
12-10	.320 8.13	.250	.409	.388	.935	.032 x .250 0.81 x 6.35	Brass	4-520447-2 <sup>3</sup>	4-520448-2			

<sup>1</sup> UL Recognized, CSA Certified.  
<sup>2</sup> UL Recognized 8 AMPS Max. CSA Certified.  
<sup>3</sup> Available with black insulator — Part Number 9-XXXXXX-2.

**Note:** All part numbers are RoHS compliant.

Ultra-Fast Fully Insulated FASTON Receptacles and Tabs

**Ultra-Fast Fully Insulated FASTON Receptacles and Tabs (Continued)**

**Ultra-Fast Fully Insulated FASTON Tabs**

**Material**

- Housing** — Nylon Type 6/6
- Flammability** — UL 94 V-2
- Terminal** — Tin plated, copper alloy
- Color Code (Translucent)**
- Red** — 22-18 AWG
- Blue** — 16-14 AWG
- Yellow** — 12-10 AWG

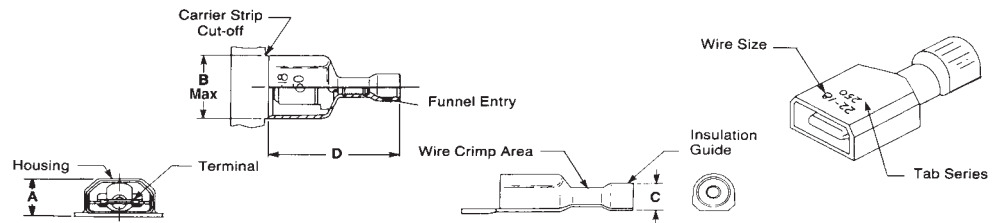

Description	Wire Range AWG	Ins. Dia. Max.	Dimensions				Tab Size	Terminal Base Material	Part Numbers			
			A	B	C	D			Strip	Loose Piece		
.250 Series	22-18	.135	.290	.522	.205	.855	.032 x .250	Brass	2-520102-2	2-520103-2		
		3.43	7.37	13.26	5.21	21.72	0.81 x 6.35					
		.230	.290	.522	.295	.935	.032 x .250					
	16-14	5.84	7.37	13.26	7.49	23.75	0.81 x 6.35	Brass	2-521144-2	2-521192-2		
		.160	.290	.522	.230	.855	.032 x .250					
		4.06	7.37	13.26	8.26	23.75	0.81 x 6.35					
12-10	.260	.290	.522	.325	.935	.032 x .250	Brass	3-521142-2	3-521191-2			
	6.60	7.37	13.26	8.26	23.75	0.81 x 6.35						
.187 Series	22-18	.320	.352	.522	.388	.935	.032 x .250	Brass	4-521097-2	4-521098-2		
		8.13	8.94	13.26	9.86	23.75	0.81 x 6.35					
		.135	.250	.448	.205	.793	.020 x .187				2-521102-2	2-521103-2
		3.43	6.35	11.38	5.21	20.14	0.51 x 4.75					
						.032 x .187	2-521104-2	2-521105-2				

**Ultra-Fast Fully Insulated FASTON Flag Receptacles**

**Material**

- Housing** — Nylon Type 6/6
- Flammability** — UL 94 V-2
- Terminal** — Tin plated, copper alloy
- Color Code (Translucent)**
- Red** — 22-18 AWG
- Blue** — 16-14 AWG
- Yellow** — 12-10 AWG

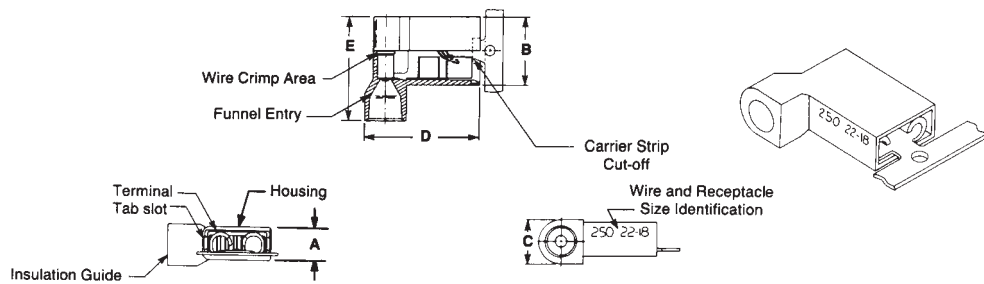

Description	Wire Range <sup>1</sup> AWG	Ins. Dia. Max.	Dimensions					Mating Tab	Terminal Base Material	Part Numbers	
			A	B	C	D	E			Strip	Loose Piece
.187 Series	22-18	.165	.187	.320	.235	.636	.515	.020 x .187	Brass	2-520334-2 <sup>2</sup>	2-520335-2
		4.19	4.75	8.13	5.97	16.15	13.08	0.51 x 4.75			
		.032 x .187	0.81 x 4.75								
	16-14	.185	.187	.320	.255	.632	.515	.020 x .187	Brass	3-520338-2	3-520339-2
		4.70	4.75	8.13	6.48	16.05	13.08	0.51 x 4.75			
		.032 x .187	0.81 x 4.75								
.250 Series	22-18	.260	.187	.320	.325	.668	.565	.020 x .187	Brass	3-520997-2	—
		6.60	4.75	8.13	8.26	16.97	14.35	0.51 x 4.75			
	16-14	.165	.187	.385	.235	.636	.580	.032 x .205	Brass	2-521164-2	—
		4.19	4.75	9.78	5.97	16.15	14.73	0.81 x 5.21			
.250 Series	22-18	.165	.187	.385	.235	.636	.580	.032 x .250	Brass	2-520128-2	2-520129-2
		4.19	4.75	9.78	5.97	16.15	14.73	0.81 x 6.35			
		.230	.187	.385	.295	.665	.630	.032 x .250			
	16-14	5.84	4.75	9.78	7.49	16.89	16.00	0.81 x 6.35	Brass	2-520856-2	—
		.185	.187	.385	.255	.632	.580	.032 x .250			
		4.70	4.75	9.78	6.48	16.05	14.73	0.81 x 6.35			
							.032 x .250	3-520132-2 <sup>2</sup>	3-520133-2		
							.032 x .250	3-521013-2	—		

<sup>1</sup> Stranded wire only.  
<sup>2</sup> Available with black insulator — Part Number 9-XXXXXX-2.

**Note:** All part numbers are RoHS compliant.



Ultra-Fast Fully Insulated FASTON Receptacles and Tabs

## Ultra-Fast Plus Fully Insulated FASTON Receptacles and Tabs

### Product Facts

- One-piece fully insulated premier line FASTON receptacle with insulation crimp helps prevent shock and short hazards
- Designed for correct lead-in of tab
- Designed for full mating with a variety of tab styles including those with shoulders
- Funnel wire entry
- Wire stop
- Visual inspection of crimp and wire brush
- Assemblies are color-coded by wire size
- Assemblies contain wire size and tab size designation
- Mating tab thickness marked on terminal and visible through housing (110 and 187 series)
- Application tooling available to meet production requirements
- Tin plated copper alloy terminals
- UL rated at +105°C
- Terminates 22-14 AWG solid, fused and stranded wire
- Complies with the IEC 380, 601, 950, and UL 1950 requirements for a secondary means of insulation fixing

### Performance Capabilities

- Meets UL-310 specification for quick connect terminals; UL listed under File No. E-66717 
- Meets CSA C22.2, No.153 specification for quick connect terminals; CSA certified under File No. LR 7189 
- 600-volt application capability (1,000 volts for signs and fixtures)

- Tested by TUV File No. E9071003 as suitable for end product certification to the following standards:

EN 60 950/09.87

DIN IEC 380/VDE 0806/08.81

DIN IEC 601-1 Part 1/VDE 0750 T1/05.82

DIN VDE 0700 T1/02.81

Ultra-Fast Plus fully insulated FASTON receptacles and tabs offer all the advantages of the standard Ultra-Fast product plus an insulation crimp.

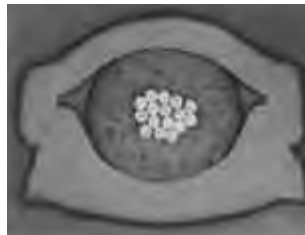

Insulation Crimp Cross Section

Ultra-Fast Plus fully insulated FASTON receptacles and tabs preclude the need for costly electrical safety interlocks or special protective shields to help prevent shock hazards. In addition, electrical short circuits from exposed leads are eliminated, even in equipment requiring close contact spacing.

Ultra-Fast Plus FASTON receptacles and tabs are preinsulated assemblies featuring a co-molded housing produced from two different nylon materials. The receptacle/ tab and wire barrel portions of the



housing are molded from type 6/6 nylon material with a +130°C UL temperature rating. The insulation barrel is molded from a premium grade nylon selected to retain the insulation crimp shape. This premium nylon exhibits minimal springback, thus providing actual insulation crimp tensile strength as well as strain relief for applications where extreme wire dressing and/or vibration are present.

The Ultra-Fast Plus FASTON receptacle housing completely encloses a tin plated copper alloy premier FASTON receptacle which has been stress relieved for increased durability and resistance to operator abuse. The FASTON receptacle is recessed sufficiently within the housing to allow its use in 600-volt applications. The receptacle portion of the terminal is designed for positive mating with a variety of tabs, including those with shoulders. The housing has a slotted membrane which is displaced by two tab shoulders allowing proper

engagement of tab and receptacle while maintaining the fully insulated characteristics.

Positive entry and lead-in of the tab is provided by the inner housing wall and the lead-in on the terminal rolls. This permits positive engagement, even in blind mating locations.

The Ultra-Fast Plus FASTON tab housing completely encloses a tin plated copper alloy FASTON tab. The FASTON tab is recessed sufficiently within the housing to allow its use in 600-volt applications. The housing is designed to completely encapsulate the tab and receptacle when the two are mated.

Quality control is easily maintained. The nylon housing is translucent, allowing visual inspection of the termination.

Depending on production requirements, TE provides a complete selection of terminating equipment from hand tools to automatic lead makers.

**Ultra-Fast Plus Fully Insulated FASTON Receptacles and Tabs** (Continued)

**Ultra-Fast Plus Fully Insulated FASTON Receptacles**

**Material**

**Housing** — Nylon

**Flammability** — UL 94 V-2

**Terminal** — Tin plated, copper alloy

**Color Code (Translucent)**

**Red** — 22-18 AWG

**Blue** — 16-14 AWG

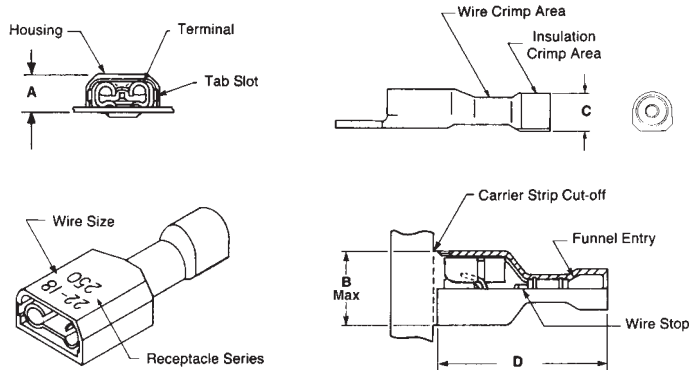

Description	Wire Range AWG	Ins. Dia. Range	Dimensions				Mating Tab	Terminal Base Material	Part Numbers	
			A	B	C	D			Strip	Loose Piece
.110/.125 Series	22-18	.060-.120 1.52-3.05	.160	.275	.167	.735	.020 x .110/.125 0.51 x 2.79/3.18	Brass	2-520932-2	—
			4.06	6.99	4.24	18.67	.032 x .110/.125 0.81 x 2.79/3.18	Brass	2-520979-2	—
.187 Series	22-18	.060-.135 1.52-3.43	.165	.336	.200	.855	.020 x .187 0.51 x 4.75	Brass	2-520401-2	2-520409-2
			4.24	8.53	5.08	21.72	.032 x .187 0.81 x 4.75	Brass	2-520403-2	2-520411-2
	16-14	.090-.160 2.29-4.06	.185	.336	.225	.855	.020 x .187 0.51 x 4.75	Brass	3-520402-2	3-520410-2
			4.70	8.53	5.72	21.72	.032 x .187 0.81 x 4.75	Brass	3-520404-2	3-520412-2
.250 Series	22-18	.060-.135 1.52-3.43	.195	.409	.200	.855	.032 x .250 0.81 x 6.35	Brass	2-520405-2	2-520407-2
			4.95	10.39	5.08	21.72	.032 x .250 0.81 x 6.35	Brass	3-520406-2	3-520408-2

**Ultra-Fast Plus Fully Insulated FASTON Tabs**

**Material**

**Housing** — Nylon

**Flammability** — UL 94 V-2

**Terminal** — Tin plated, copper alloy

**Color Code (Translucent)**

**Red** — 22-18 AWG

**Blue** — 16-14 AWG

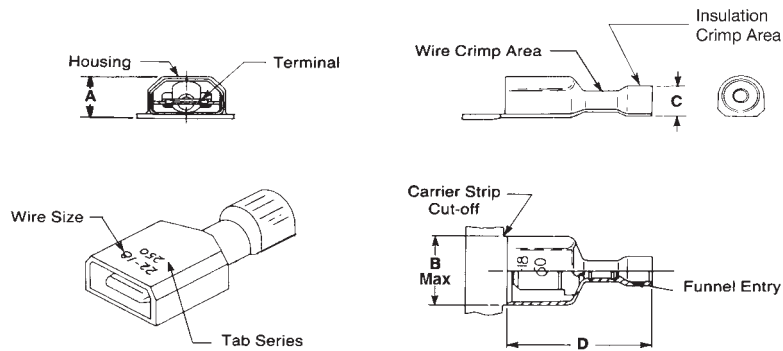



Description	Wire Range AWG	Ins. Dia. Range	Dimensions				Mating Tab	Terminal Base Material	Part Numbers	
			A	B	C	D			Strip	Loose Piece
.187 Series	22-18	.060-.135 1.52-3.43	.250	.488	.205	.793	.020 x .187 0.51 x 4.75	Brass	2-521360-2	—
			6.35	11.38	5.21	20.14	.032 x .187 0.81 x 4.75	Brass	2-521361-2	—
.250 Series	22-18	.060-.135 1.52-3.43	.290	.522	.205	.855	.032 x .250 0.81 x 6.35	Brass	2-521055-2	—
			7.37	13.26	5.21	21.72	.032 x .250 0.81 x 6.35	Brass	3-521057-2	—
	16-14	.090-.160 2.29-4.06	.290	.522	.230	.855	.032 x .250 0.81 x 6.35	Brass	3-521057-2	—

**Note:** All part numbers are RoHS compliant.

## Ultra-Pod Fully Insulated FASTON Receptacles and Tabs

### Product Facts

- Reduced insertion force
- Designed for correct lead-in of tab
- Mates with typical 110, 187 and 250 series tab styles including those with shoulders
- 110 series accepts 22-18 AWG [0.3–1 mm<sup>2</sup>], 187 series accepts 20-16 AWG [0.5–1.4mm<sup>2</sup>] wire and 250 series accepts 22-10 AWG [0.3–5 mm<sup>2</sup>] wire
- Visual inspection of crimp and wire brush
- Terminated by automatic or semi-automatic equipment to meet production requirements
- Complies with the IEC 380, 601 and 950 and UL 1950 requirements for a secondary means of insulation fixing
- Listed by Underwriters Laboratories Inc., File No. E66717 
- CSA certified, File No. LR 7189 

### Technical Documents

#### Product Specification

108-1285  
108-2215

#### Application Specification

114-2124

### Hand Tools — Insertion

250 Series—314916-1  
250 Series Flag—314919-1

### Hand Tools — Extraction

250 Series—314917-1

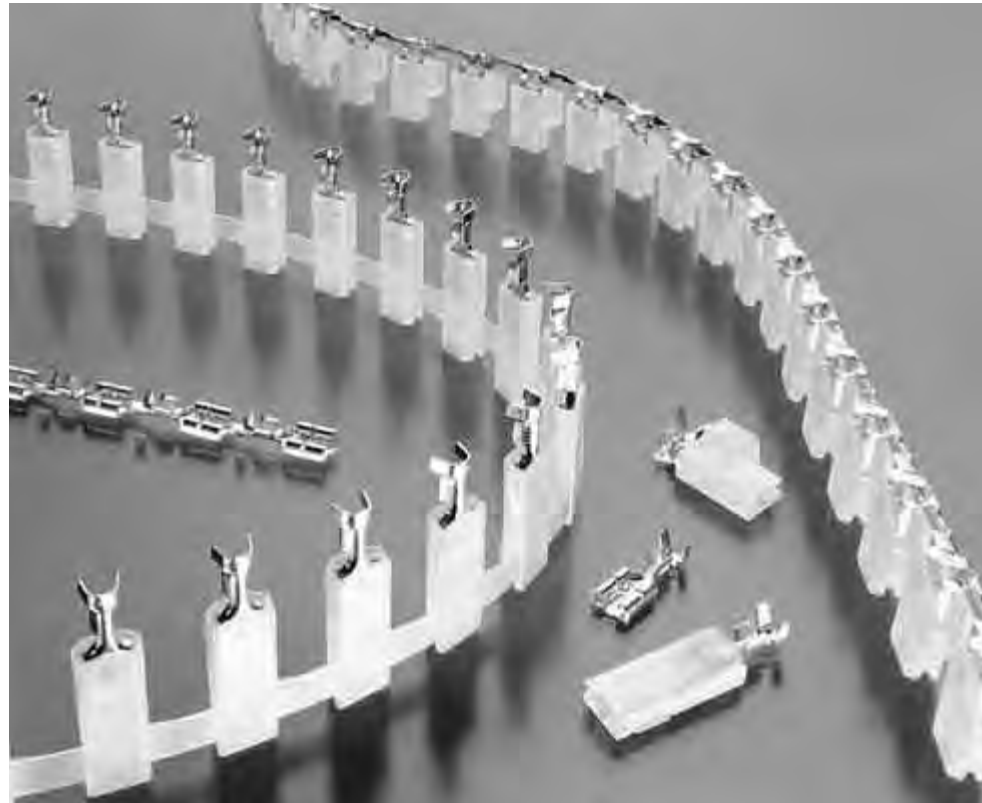

Ultra-Pod fully insulated FASTON receptacles offer the newest in one-step automatic application of insulated quick connects. The unique integral plastic carrier designed specifically for this product allows insulated F-Crimp terminations to be produced quickly and easily. Applied cost savings are attainable with either bench or high-speed automatic termination equipment and the elimination of any secondary insulation operations. Both the crimping of the terminal and the terminal insulating occur in a single stroke of the press and applicator — the crimping on the down-stroke and the insulating on the up-stroke.

The receptacles contained within the Ultra-Pod FASTON receptacle assemblies are tested and customer qualified and can be used in existing applications where insulation has been accomplished by other means. The low insertion force design provides easier tab insertion, reduces operator fatigue and improves the productivity and reliability of the end assembly operation.

The insulating housing is produced by a unique molding process which provides an integral carrier and eliminates the crimp location problems related to secondary carriers. This housing, produced from 130°C rated 6/6 nylon,

covers the FASTON receptacle sufficiently to provide for use in 600-volt applications. Most importantly, this insulating system helps eliminate the workplace hazards and labor costs of chemically expanded or heat shrink tubing.

Depending on production requirements, TE provides a complete selection of terminating equipment from bench press to automatic lead maker.

**Ultra-Pod Fully Insulated FASTON Receptacles and Tabs** (Continued)

**Insulation Support**

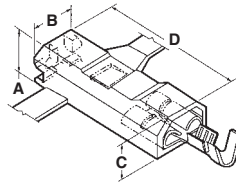

Description	Wire Range	Ins. Dia. Range	Dimensions				Mating Tab	UL 94 <sup>1</sup>	Color	Material and Finish	Part Numbers
			A	B	C	D					
.110 Series	22-18	.080-.120 2.03-3.05	.151 3.83	.224 5.69	.205 5.21	.805 20.45	.020 0.51	V-2	Natural	Brass	521228-1
										Tin Plated Brass	521228-2
										Tin Plated Brass	521408-2 <sup>4</sup>
										Brass	521436-1 <sup>4</sup>
										Tin Plated Brass	521436-2
										Brass	521437-1 <sup>4</sup>
Tin Plated Brass	521437-2 <sup>2,4</sup>										
.187 Series	20-16	.090-.130 2.29-3.30	.170 4.32	.295 7.49	.200 5.08	.775 19.68	.020 0.51	V-2	Natural	Brass	520973-1
										Tin Plated Brass	520973-2
										Brass	521225-1
										Tin Plated Brass	521225-2
										Brass	520982-1
										Tin Plated Brass	520982-2
	18-16 or 2-18	(2) .105 Max. 2.67	.170 5.33	.295 7.49	.200 5.08	.775 19.68	.020 0.51	V-2	Natural	Tin Plated Brass	521284-1
										Tin Plated Brass	521284-2
										Brass	521293-1
										Tin Plated Brass	521293-2
										Brass	521586-1
										Tin Plated Brass	521586-2
.250 Series	22-18	.090-.130 2.29-3.30	.195 4.95	.370 9.40	.225 5.72	.945 24.00	.032 0.81	V-2	Natural	Brass	520988-1
										Tin Plated Brass	520988-2
										Brass	521368-1
										Tin Plated Brass	521368-2
										Brass	521997-1 <sup>4,5</sup>
										Tin Plated Brass	520963-1
	18-14	(2) .105 Max. 3.05-4.32	.195 4.95	.370 9.40	.225 5.72	.945 24.00	.032 0.81	V-0	Natural	Brass	521367-1
										Tin Plated Brass	521367-2
										Tin Plated Brass	521011-2 <sup>2</sup>
										Nickel Plated Steel	521011-1 <sup>2,3</sup>
										Nickel Plated Steel	521113-2 <sup>3</sup>
										Brass	521637-1
18-14 or 2-18	(2) .105 Max. 4.95	.195 4.95	.370 9.40	.225 5.72	.945 24.00	.032 0.81	V-2	Natural	Tin Plated Brass	521637-2	
									Tin Plated Brass	521998-2 <sup>4,5</sup>	
									Brass	521632-1	
									Tin Plated Brass	521632-2	
									Brass	520974-1	
									Tin Plated Brass	520974-2	
14-10	.130-.180 3.30-4.57	.195 4.95	.370 9.40	.225 5.72	.945 24.00	.032 0.81	V-2	Natural	Brass	521366-1	
									Tin Plated Brass	521366-2	

<sup>1</sup> Flammability rating of plastic material.  
<sup>2</sup> 150°C rated nylon.  
<sup>3</sup> UL recognized.  
<sup>4</sup> No UL or CSA approvals.  
<sup>5</sup> VDE certified to IEC 60695-2-11 Glow Wire temps. 650°C, 750°C, & 850°C.

**Note:** All part numbers are RoHS compliant.

Ultra-Pod Fully Insulated FASTON Receptacles



**Ultra-Pod Fully Insulated FASTON Receptacles and Tabs** (Continued)

**Flag Insulation Support**

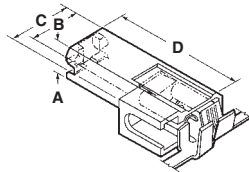

Description	Wire Range	Ins. Dia. Range	Dimensions				Mating Tab	UL 94 <sup>1</sup>	Color	Material and Finish	Part Numbers
			A	B	C	D					
.187 Series	22-18	.060-.110 1.52-2.79	.170 4.32	.295 7.49	.485 12.32	.680 17.27	.020 0.51	V-2	Natural	Brass	521470-1 <sup>4</sup>
										Tin Plated Brass	521470-2 <sup>4</sup>
										1969106-2 <sup>3,5</sup>	
										Brass	521596-1 <sup>4</sup>
										Tin Plated Brass	521596-2 <sup>4</sup>
										521598-1 <sup>3</sup>	
	18-14 or (2) 20 or (2) 18	(2) .105 Max. 2.66	.170 4.32	.295 7.49	.485 12.32	.680 17.27	.032 0.81	V-2	Natural	Brass	521598-1 <sup>3</sup>
										Tin Plated Brass	521598-2 <sup>3</sup>
										Brass	521600-1 <sup>4</sup>
										Tin Plated Brass	521600-2 <sup>4</sup>
										521471-1 <sup>4</sup>	
										521471-2 <sup>4</sup>	
.250 Series	22-18	.050-.100 1.27-2.54	.200 5.08	.370 9.40	.585 14.86	.680 17.27	.032 0.81	V-2	Natural	Brass	521050-1
										Tin Plated Brass	521050-2
										521411-1	
										Brass	521411-2
										1969109-1 <sup>3,5</sup>	
										1969109-2 <sup>3,5</sup>	
	18-14	(2) .105 Max. 2.79-4.06	.200 5.08	.370 9.40	.585 14.86	.680 17.27	.032 0.81	V-2	Natural	Brass	520971-1
										Tin Plated Brass	520971-2
										Tin Plated Brass	520971-4
										Nickel Plated Steel	521087-1 <sup>3</sup>
										521282-1	
										521282-2	
18-14 or (2) 20 or (2) 18	(2) .105 Max. 2.66	.200 5.08	.370 9.40	.585 14.86	.680 17.27	.032 0.81	V-2	Natural	Brass	521112-1	
									Tin Plated Brass	1969110-2 <sup>3,5</sup>	
									521633-1		
									521633-2		

<sup>1</sup>Flammability rating of plastic material.  
<sup>2</sup>UL pending for double wire terminations.  
<sup>3</sup>No UL or CSA approvals.  
<sup>4</sup>No CSA approvals.  
<sup>5</sup>VDE certified to IEC 60695-2-11 Glow Wire temps. 650°C, 750°C, & 850°C.

**Note:** All part numbers are RoHS compliant.

**Ultra-Pod Fully Insulated FASTON Receptacles and Tabs** (Continued)

**Positive Lock  
Insulation Support**

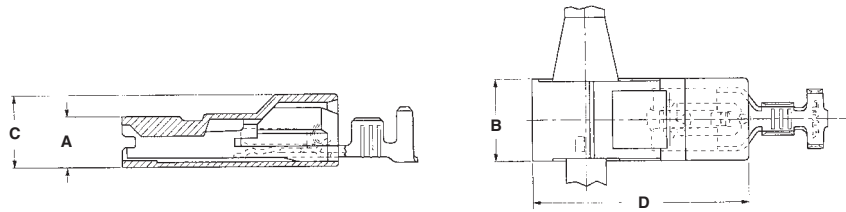

Description	Wire Range	Ins. Dia. Range	Dimensions				Mating Tab	UL 94 <sup>1</sup>	Color	Material and Finish	Part Numbers
			A	B	C	D					
.187 Series	18-14	.110-.180 2.79-4.57	.186	.307	.265	.812	.020	V-2	Natural	Brass	521271-1 <sup>2</sup>
			4.72	7.80	6.73	20.62	0.51			Tin Plated Brass	521271-2 <sup>2</sup>
.250 Series	18-14	.110-.180 2.79-4.57	.205	.370	.245	.950	.032	V-2	Natural	Brass	521213-1 <sup>2</sup>
			5.21	9.40	6.22	24.13	0.81			Tin Plated Brass	521213-2 <sup>2</sup>
			.032	0.81	V-0	Natural	Brass	521317-1 <sup>2</sup>			
							Tin Plated Brass	521317-2 <sup>2</sup>			

<sup>1</sup> Flammability rating of plastic material.  
<sup>2</sup> UL Recognized, CSA Certified

**Tabs  
Insulation Support**

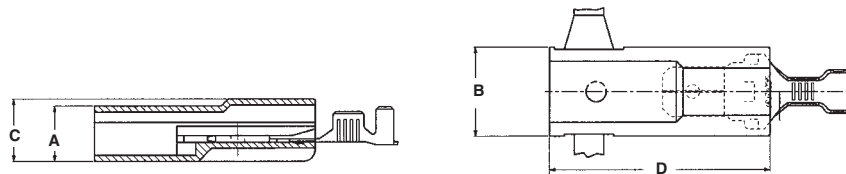

Description	Wire Range	Ins. Dia. Range	Dimensions				Tab	UL 94 <sup>1</sup>	Color	Material and Finish	Part Numbers
			A	B	C	D					
.250 Series	18-14	.130-.180 3.30-4.57	.275	.450	.310	1.120	.032	V-2	Natural	Brass	521217-1
			6.99	11.43	7.87	28.45	0.81			Tin Plated Brass	521217-2
	12-10	.150-.200 3.81-5.08	.275	.450	.310	1.120	.032	V-0	Natural	Brass	521451-1
										6.99	11.43
.032	0.81	V-2	Natural	Brass	521227-1 <sup>2</sup>						
				Tin Plated Brass	521227-2 <sup>2</sup>						

<sup>1</sup> Flammability rating of plastic material.  
<sup>2</sup> No UL or CSA approvals

**Note:** All part numbers are RoHS compliant.

## PIDG FASTON Receptacles and Tabs

### Product Facts

- Pre-insulated terminal designed for complete and uniform reliability in the most difficult circuit environment
- Consists of an unplated or tin plated brass body or a tin plated phosphor bronze body with a specially designed copper sleeve and insulation sleeve fitted over the terminal barrel
- Design of the tool dies and construction of the terminal insures uniform insulation thickness under crimping pressure, transmitting this pressure evenly to the center of the crimp area

### The TE Mated Tool/Terminal Concept

- TE compression crimping produces crimps for a given size wire and terminal that are precisely alike in appearance and performance
- Terminal and the crimping tool are designed as precisely matched devices
- Dies are precision-engineered from the finest hard-metal alloys
- Crimping pressure is controlled by a ratchet device on the hand tool or a corresponding pre-calibration in the crimping jaws of TE automated crimping machines

### The Crimp

- Crimping pressure does not overstress nor understress the terminal barrel — machined dies fully bottom to the precise crimp height
- Resulting termination is free of contamination
- Resistant to most shock and critical environments
- Tensile strength approaches that of the wire itself



Here is a pre-insulated terminal designed for complete and uniform reliability in most difficult circuit environments. Each PIDG Terminal consists of a tin plated brass body with a specially designed copper sleeve and insulation sleeve fitted over the terminal barrel. The design of the tool dies and the construction of the terminal promotes uniform insulation thickness under crimping pressure, transmitting this pressure evenly to the center of the crimp area.

TE compression crimping produces crimps for a given size wire and terminal that are precisely alike in appearance and performance. This is a calculated result made possible by designing the terminal and the crimping tool as precisely matched devices. The dies are precision-engineered from the finest hard-metal alloys. Crimping pressure is controlled by a ratchet device on the hand tool or a corresponding pre-calibration in the crimping

jaws of TE automated crimping machines.

Crimping pressure can neither over-stress nor understress the terminal barrel — machined dies fully bottom to the precise crimp height required.

The resulting termination is free of contamination, is resistant to shock and critical environments, and its tensile strength approaches that of the wire itself.

### Temperature Rating: 105° C

Wire Range	 E66717 Recognized	 LR7189 Certified
22-16	22-16 Stranded	300 V Max., 105°C Max. <sup>1</sup>
16-14	16-14 Stranded	
12-10	12-10 Stranded	

<sup>1</sup> UL and CSA — Nylon.

**PIDG FASTON Receptacles and Tabs** (Continued)

**Receptacles**

**Receptacle Style**

- A** — No dimple with wire stop
- B** — Dimple with wire stop
- C** — No dimple, no wire stop

**Material**

- Insulation** — Nylon
- Receptacle Body** — Brass per ASTM B-36 or phosphor bronze per ASTM B-139
- Plating** — Tin per MIL-T-10727 except where noted.
- Metallic Sleeve** — Copper per ASTM B-152
- Plating** — Tin per MIL-T-10727

**Related Product Data**

**Application Tooling** — reference Catalog 82042 for tooling

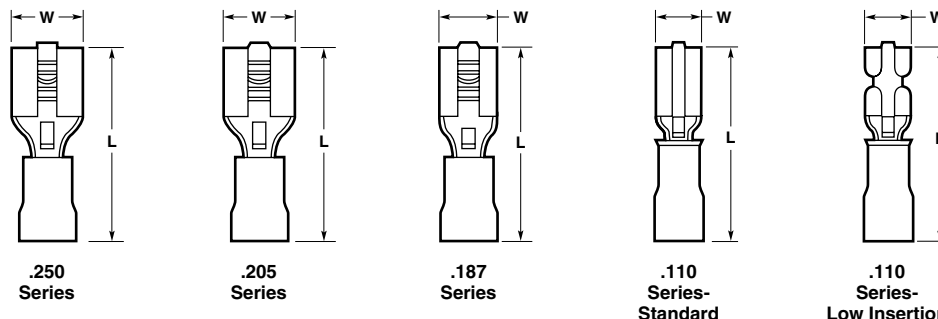

Series	Wire Size Circular Mils [mm <sup>2</sup> ]	Style	Dimensions		Terminal Insulation Color	Wire Insulation Diameter Max.	Recept. Matl.	Stock Thk.	Fits Tab Thk.	Part Numbers		
			W Nom.	L Max.						Loose Piece	Tape Mounted	Strip Form
.250	22-18 509-1,900 [0.26-0.96]	B	.300 7.62	.900 22.86	Red	.140 3.56	Brass	.018 0.46	.032 0.81	640903-1*	640903-2	640902-1
	Red				.140 3.56	Brass	.018 0.46	.032 0.81	55675-1 <sup>2</sup>	55675-2 <sup>2</sup>	—	
	16-14 2,050-5,180 [1.04-2.62]	B	.300 7.62	.900 22.86	Blue	.170 4.32	Brass	.018 0.46	.032 0.81	640905-1*	640905-2	640904-1
	Green				.250 6.35	Brass	.018 0.46	.032 0.81	42844-1**	42844-3†	60544-3†	
	14-12 3,831-6,470 <sup>1</sup> [1.94-3.28]	B	.300 7.62	1.012 25.70	Green	.250 6.35	Phos. Brz.	.018 0.46	.032 0.81	42844-2**	—	—
	Yellow				.250 6.35	Brass	.018 0.46	.032 0.81	640907-1*	640907-2	640906-1	
12-10 5,180-13,100 [2.62-6.64]	B	.300 7.62	1.012 25.70	Yellow	.250 6.35	Phos. Brz.	.018 0.46	.032 0.81	61198-2 <sup>3†</sup>	61198-4 <sup>4†</sup>	61197-2	
Yellow				.250 6.35	Phos. Brz.	.018 0.46	.032 0.81	61198-2 <sup>3†</sup>	61198-4 <sup>4†</sup>	61197-2		
.250 Low Insertion	22-18 509-1,900 [0.26-0.96]	B	.300 7.62	.900 22.86	Red	.145 3.68	Brass	.016 0.41	.032 0.81	184262-1†	184262-2†	184261-1†
	Blue				.173 4.39	Brass	.016 0.41	.032 0.81	184265-1†	184265-2†	184264-1†	
.205 Low Insertion	22-18 509-1,900 [0.26-0.96]	B	.250 6.35	.800 20.32	Red	.135 3.43	Brass	.016 0.41	.020 0.51	696018-1†	696018-2†	—
	Red				.140 3.56	Brass	.016 0.41	.020 0.51	640909-1*	640909-2	640908-1	
.205	22-18 509-1,900 [0.26-0.96]	B	.250 6.35	.800 20.32	Red/Black	.140 3.56	Brass	.016 0.41	.020 0.51	640174-1	—	—
					Red	.140 3.56	Brass	.016 0.41	.032 0.81	640911-1*	640911-2	—
	16-14 2,050-5,180 [1.04-2.62]	B	.250 6.35	.800 20.32	Blue	.170 4.32	Brass	.016 0.41	.020 0.51	640913-1*	640913-2	—
					Blue	.170 4.32	Brass	.016 0.41	.032 0.81	640915-1*	640915-2	—
.187	26-24 238-475 [0.12-0.24]	B	.230 5.84	.700 17.78	Yellow	.082 2.08	Brass	.016 0.41	.020 0.51	641321-1**	641321-2†	641320-1†
	22-18 509-1,900 [0.26-0.96]				B	.230 5.84	.800 20.32	Red	.140 3.56	Brass	.016 0.41	.020 0.51

† Not UL or CSA approved or listed.

\* Available in small packaging quantities.

<sup>1</sup> Wire range is limited as noted.

<sup>2</sup> Unplated receptacle body.

<sup>3</sup> Requires tool 90276-2

<sup>4</sup> Requires die 58541-1

**Note:** All part numbers are RoHS compliant.

**PIDG FASTON Receptacles and Tabs** (Continued)

**Receptacles** (Continued)

Series	Wire Size Circular Mils [mm <sup>2</sup> ]	Style	Dimensions		Terminal Insulation Color	Wire Insulation Diameter Max.	Recept. Matl.	Stock Thk.	Fits Tab Thk.	Part Numbers		
			W Nom.	L Max.						Loose Piece	Tape Mounted	Strip Form
.187	16-14 2,050-5,180 [1.04-2.62]	B	.230	.800	Blue	.170	Brass	.016	.020	640919-1*	640919-2	640918-1
			5.84	20.32	Blue	4.32	0.41	0.51	640910-1†	640910-2†	—	
.187 Low Insertion	16-14 509-1,900 [0.26-0.96]	B	.235	.800	Blue	.170	Brass	.016	.032	184235-1†	184235-2†	—
			5.84	20.32	Blue	4.32	0.41	0.81	696777-2	—	696776-1	
.110 Standard	22-18 509-1,900 [0.26-0.96]	B	.148	.734	Natural	.110	Brass	.012	.016	61048-1**	61048-2†	—
			3.76	18.64	Natural	2.79	0.30	0.41	61060-1**	61060-2†	61059-2†	
			.148	.734	Natural	.110	Brass	.012	.020	60894-1**	60894-2†	60893-2†
.110 Low Insertion	26-24 238-475 [0.12-0.24]	A	.160	.700	Yellow	.082	Brass	.016	.020	641324-1†	641324-2†	—
			4.06	17.78	Yellow	2.08	0.41	0.51	—	—	350871-1†	
.110 Low Insertion	22-18 509-1,900 [0.26-0.96]	A	.160	.796	Red	.140	Brass	.016	.012	—	—	—
			4.06	20.22	Red	3.56	0.41	0.30	.016	640921-1	640921-2	—
			.160	.800	Red	.140	Brass	.016	.020	.016	640923-1*	640923-2
.110 Low Insertion	22-18 509-1,900 [0.26-0.96]	A	.160	.800	Red	.140	Brass	.016	.032	640925-1*	640925-2	640924-1
			4.06	20.32	Red	3.56	0.41	0.81	.020	640929-1*	640929-2	—
			.160	.800	Blue	.170	Brass	.016	.032	.016	640931-1*	640931-2
.110 Low Insertion	16-14 2,050-5,180 [1.04-2.62]	A	.160	.800	Blue	.170	Brass	.016	.016	640927-1	640927-2	—
			4.06	20.32	Blue	4.32	0.41	0.41	—	—	—	

†Not UL or CSA approved or listed.

\*Available in small packaging quantities.

**Tooling for Insulated FASTON Receptacles and Tabs — 26 to 10 AWG Wire Range**

Wire Size	Hand Tool	Tools for Tape Mounted Terminations			Tools for Strip Form Terminations
		Tape Dies for 69875 AMP-TAPETRONIC No Applicator Required	Tape Dies for AMP-O-LECTRIC <sup>1</sup> Model "G" Applicator 567200-3	Tape Dies for AMPOMATOR CLS III G, CLS IV Applicator 687658-1	AMPOMATOR CLS III G, CLS IV Applicators
26-24	48518-2	69877-2	69877-2	69877-2	—
22-18	59824-1	59826-1	59826-1*	59826-1	466788-3 <sup>2</sup>
22-18 (Natural)	90185-1	90248-2	90248-2	90248-2	466554-3
16-14	59824-1	59827-1	59827-1*	59827-1	466789-3 <sup>2</sup>
14-12	90246-1	90240-2	90240-2	90240-2	—
12-10	59824-1	59828-1	59828-1*	59828-1	466790-4 <sup>2</sup>

<sup>1</sup>Only UL and CSA approved.

<sup>1</sup>AMP-O-LECTRIC model "K" 565435-5 uses applicator 567200-2.

<sup>2</sup>Die included with applicator.

**Note:** All part numbers are RoHS compliant.

**PIDG FASTON Receptacles and Tabs** (Continued)

**Positive Lock Receptacle**  
**Low Insertion Force with**  
**Locking Device**

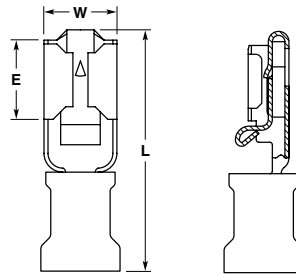

Description	Wire Range	Ins. Dia. Max.	Dimensions			Material and Finish	Part Number
			W	L	E		
For Tab .250 x .032	16-14	.190 4.83	.362 9.19	.850 21.59	.315 8.00	Tin Plated Brass	165536-1†

†Not UL or CSA approved or listed.

**Tab**

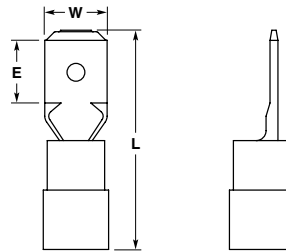

Description	Wire Range	Ins. Dia. Max.	Dimensions			Material and Finish	Part Number
			W	L	E		
For Receptacle .250 x .032	22-18	.157 3.99	.250 6.35	.866 22.00	.300 7.62	Tin Plated Brass	696362-1
	16-14	.197 5.00	.250 6.35	.866 22.00	.300 7.62	Tin Plated Brass	696369-1
	12-10	.256 6.50	.250 6.35	.950 24.13	.300 7.62	Tin Plated Brass	696372-1

**PIDG FASTON**  
**Flag Receptacles**

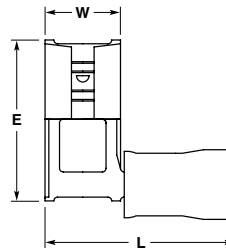

Description	Wire Range	Ins. Dia. Max.	Dimensions			Material and Finish	Part Number
			W	L	E		
For Tab .250 x .032	22-18	.134 3.40	.300 7.62	.720 18.29	.610 15.49	Tin Plated Brass	156667-1
	16-14	.157 3.99	.300 7.62	.720 18.29	.610 15.49	Tin Plated Brass	156666-1

**Note:** All part numbers are RoHS compliant.

**PIDG FASTON Receptacles and Tabs** (Continued)

**Fully Insulated Receptacles**

Insulation Sleeve — Nylon

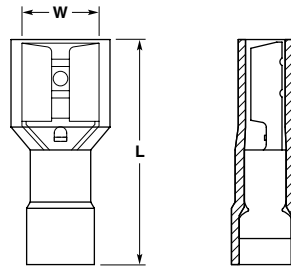

Description	Wire Range	Ins. Dia. Range	Dimensions		Material and Finish	Part Number
			W	L		
For Tab .250 x .032	22-18	.128 3.25	.375 9.53	.891 22.63	Tin Plated Brass	696357-1
	16-14	.165 4.19	.375 9.53	.881 22.38	Tin Plated Brass	696366-1
	12-10	.225 5.72	.375 9.53	.998 25.35	Tin Plated Brass	696371-1

**Budget Line PIDG FASTON Receptacles**

**Material**

Insulation — PVC, UL 94V-0

Receptacle Body — Brass

Plating — Tin

Metallic Sleeve — Copper

Plating — Tin

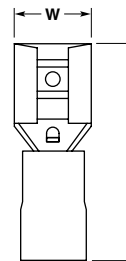

Series	Wire Size Circular Mills [mm <sup>2</sup> ]	Dimensions		Terminal Color	Wire Insulation Diameter Max.	Fits Tab Thk.	Part Numbers	
		W Nom.	L Nom.				Loose Piece	Tape Mounted
.250	22-18	.300 7.62	.819 20.80	Red	.150 3.81	.032 0.81	696301-1	696301-2
	16-14	.300 7.62	.819 20.80	Blue	.185 4.70	.032 0.81	696302-1	696302-2

**Note:** All part numbers are RoHS compliant.

# Mouser Electronics

Authorized Distributor

Click to View Pricing, Inventory, Delivery & Lifecycle Information:

[TE Connectivity:](#)

[2-520080-2](#) [2-520080-2 \(Cut Strip\)](#)