

**MAXIM**

# 150mA, Low-Dropout Linear Regulator with Power-OK Output

**MAX8875**

## General Description

The MAX8875 low-dropout linear regulator operates from a +2.5V to +6.5V input range and delivers up to 150mA. A P-channel MOSFET pass transistor allows its 85 $\mu$ A supply current to remain independent of the load, making this device ideal for battery-operated portable equipment such as PCS phones, cellular phones, cordless phones, and modems.

The MAX8875 features a power-OK (POK) output that indicates when the output is out of regulation. The device is available in several preset output voltage versions: 5.0V, 3.3V, 3.0V, 2.7V, 2.5V, or 1.5V. Other features include 1 $\mu$ A (max) shutdown current, short-circuit protection, thermal shutdown protection, and reverse-battery protection. The device comes in a miniature 5-pin SOT23 package.

The MAX8875 is optimized for use with a 1 $\mu$ F ceramic output capacitor. For a pin-compatible, functionally equivalent device for use with a higher ESR output capacitor, see the MAX8885 data sheet.

## Applications

PCS Telephones	Hand-Held Instruments
Cellular Telephones	Palmtop Computers
Cordless Telephones	Electronic Planners
PCMCIA Cards	Modems

## Typical Operating Circuit

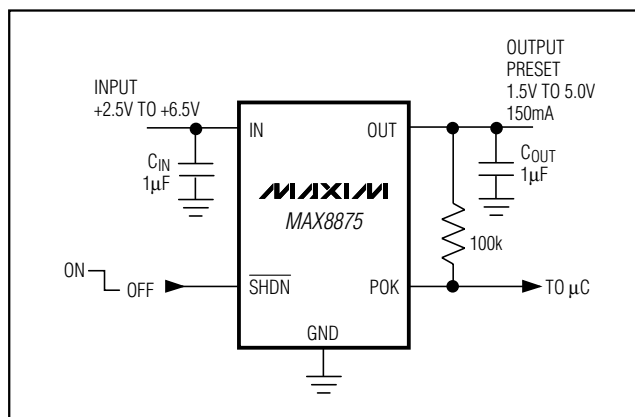

## Features

- ◆ Power-OK Output
- ◆ Small Output Capacitor (1 $\mu$ F ceramic)
- ◆ Preset Output Voltages ( $\pm$ 1% accuracy)
- ◆ Guaranteed 150mA Output Current
- ◆ 85 $\mu$ A No-Load Supply Current
- ◆ Low 110mV Dropout at 100mA Load (165mV at 150mA load)
- ◆ Thermal-Overload and Short-Circuit Protection
- ◆ Reverse-Battery Protection
- ◆ 60dB PSRR at 100Hz
- ◆ 1 $\mu$ A max Shutdown Current

## Ordering Information

PART*	TEMP. RANGE	PIN-PACKAGE
MAX8875EUKxy-T	-40°C to +85°C	5 SOT23-5

\*xy is the output voltage code (see Output Voltage Selector Guide).

## Output Voltage Selector Guide

PART	V <sub>OUT</sub> (V)	TOP MARK
MAX8875EUK15-T	1.5	ADQI
MAX8875EUK25-T	2.5	ADKZ
MAX8875EUK27-T	2.7	ADLA
MAX8875EUK30-T	3.0	ADLB
MAX8875EUK33-T	3.3	ADLC
MAX8875EUK50-T	5.0	ADLD

**Note:** Other output voltages between 1.5V and 5.0V are available in 100mV increments—contact the factory for information. Minimum order quantity is 25,000 units.

## Pin Configuration

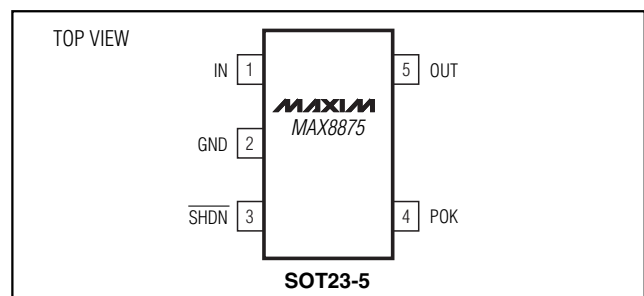
**MAXIM**

Maxim Integrated Products 1

For price, delivery, and to place orders, please contact Maxim Distribution at 1-888-629-4642, or visit Maxim's website at [www.maxim-ic.com](http://www.maxim-ic.com).

# 150mA, Low-Dropout Linear Regulator with Power-OK Output

## ABSOLUTE MAXIMUM RATINGS

IN, $\overline{\text{SHDN}}$ , POK to GND.....	-7V to +7V
$\overline{\text{SHDN}}$ to IN.....	-7V to +0.3V
OUT to GND.....	-0.3V to ( $V_{\text{IN}} + 0.3\text{V}$ )
Output Short-Circuit Duration.....	Indefinite
Continuous Power Dissipation ( $T_A = +70^\circ\text{C}$ ) 5-Pin SOT23 (derate 7.1mW/ $^\circ\text{C}$ above +70 $^\circ\text{C}$ ).....	571mW

Operating Temperature Range.....	-40 $^\circ\text{C}$ to +85 $^\circ\text{C}$
Junction Temperature.....	+150 $^\circ\text{C}$
$\theta_{\text{JA}}$ .....	+140 $^\circ\text{C}/\text{W}$
Storage Temperature Range.....	-65 $^\circ\text{C}$ to +150 $^\circ\text{C}$
Lead Temperature (soldering, 10s).....	+300 $^\circ\text{C}$

Stresses beyond those listed under "Absolute Maximum Ratings" may cause permanent damage to the device. These are stress ratings only, and functional operation of the device at these or any other conditions beyond those indicated in the operational sections of the specifications is not implied. Exposure to absolute maximum rating conditions for extended periods may affect device reliability.

## ELECTRICAL CHARACTERISTICS

( $V_{\text{IN}} = V_{\text{OUT(NOMINAL)}} + 1\text{V}$ ,  $\overline{\text{SHDN}} = \text{IN}$ ,  $T_A = -40^\circ\text{C}$  to +85 $^\circ\text{C}$ , unless otherwise noted. Typical values are at  $T_A = +25^\circ\text{C}$ .) (Note 1)

PARAMETER	SYMBOL	CONDITIONS	MIN	TYP	MAX	UNITS
Input Voltage	$V_{\text{IN}}$		2.5		6.5	V
Output Voltage Accuracy		$T_A = +25^\circ\text{C}$ , $I_{\text{OUT}} = 100\mu\text{A}$	-1.0		1.0	%
		$T_A = -40^\circ\text{C}$ to +85 $^\circ\text{C}$	-2		2	
		$I_{\text{OUT}} = 100\mu\text{A}$	-3		2	
		$I_{\text{OUT}} = 100\mu\text{A}$ to 120mA				
Maximum Output Current	$I_{\text{OUT}}$		150			mA
Current Limit	$I_{\text{LIM}}$		160	390		mA
Ground Pin Current	$I_{\text{Q}}$	$I_{\text{OUT}} = 100\mu\text{A}$		85	180	$\mu\text{A}$
		$I_{\text{OUT}} = 150\text{mA}$		100		
Dropout Voltage (Note 2)	$V_{\text{IN}} - V_{\text{OUT}}$	$I_{\text{OUT}} = 100\mu\text{A}$		0.1		mV
		$I_{\text{OUT}} = 50\text{mA}$		50		
		$I_{\text{OUT}} = 100\text{mA}$		110	220	
		$I_{\text{OUT}} = 150\text{mA}$		165		
Line Regulation	$\Delta V_{\text{LNR}}$	$V_{\text{IN}} = 2.5\text{V}$ or ( $V_{\text{OUT}} + 0.1\text{V}$ ) to 6.5V, $I_{\text{OUT}} = 1\text{mA}$	-0.15	0	0.15	%/V
Load Regulation	$\Delta V_{\text{LDR}}$	$I_{\text{OUT}} = 100\mu\text{A}$ to 120mA, $C_{\text{OUT}} = 1\mu\text{F}$		0.01		%/mA
Output Voltage Noise		$C_{\text{OUT}} = 10\mu\text{F}$ , $f = 10\text{Hz}$ to 100kHz		170		$\mu\text{V}_{\text{RMS}}$
Output Voltage AC Power-Supply Rejection Ratio	PSRR	$f = 100\text{Hz}$		60		dB
<b>SHUTDOWN</b>						
Shutdown Supply Current	$I_{\text{OFF}}$	$\overline{\text{SHDN}} = \text{GND}$	$T_A = +25^\circ\text{C}$	0.005	1	$\mu\text{A}$
			$T_A = +85^\circ\text{C}$	0.02		
$\overline{\text{SHDN}}$ Input Threshold	$V_{\text{IH}}$	$V_{\text{IN}} = 2.5\text{V}$ to 5.5V		2.0		V
	$V_{\text{IL}}$				0.4	
$\overline{\text{SHDN}}$ Input Bias Current	$I_{\overline{\text{SHDN}}}$	$\overline{\text{SHDN}} = \text{IN}$ or GND	$T_A = +25^\circ\text{C}$	0	100	nA
			$T_A = +85^\circ\text{C}$	0.05		

# 150mA, Low-Dropout Linear Regulator with Power-OK Output

## ELECTRICAL CHARACTERISTICS (continued)

( $V_{IN} = V_{OUT(NOMINAL)} + 1V$ ,  $\overline{SHDN} = IN$ ,  $T_A = -40^{\circ}C$  to  $+85^{\circ}C$ , unless otherwise noted. Typical values are at  $T_A = +25^{\circ}C$ .) (Note 1)

PARAMETER	SYMBOL	CONDITIONS	MIN	TYP	MAX	UNITS		
<b>POWER-OK OUTPUT</b>								
Power-OK Voltage Threshold	$V_{POK}$	1 - $V_{OUT}/V_{OUT(NOMINAL)} = 100$ , $I_{OUT} = 0$ , $V_{OUT}$ falling, $V_{OUT} \geq 2.5V$	-3	-5	-8	%		
		1 - $V_{OUT}/V_{OUT(NOMINAL)} = 100$ , $I_{OUT} = I_{LIM}$ , $V_{OUT}$ falling, $V_{OUT} < 2.5V$	$T_A = 0^{\circ}C$ to $+85^{\circ}C$		-8.5		-10.5	-13.5
		$T_A = -40^{\circ}C$ to $+85^{\circ}C$		-7			-15	
		In dropout, $V_{OUT}$ falling, $V_{OUT} \geq 2.5V$		-5.3				
		Hysteresis, $I_{OUT} = 0$	1					
POK Output Voltage Low	$V_{OL}$	$I_{SINK} = 1mA$			0.4	V		
POK Output Leakage Current		$0 \leq V_{POK} \leq 6.5V$ , $V_{OUT}$ in regulation			1	$\mu A$		
<b>THERMAL PROTECTION</b>								
Thermal Shutdown Temperature	$T_{SHDN}$			170		$^{\circ}C$		
Thermal Shutdown Hysteresis	$\Delta T_{SHDN}$			20		$^{\circ}C$		

**Note 1:** Limits are 100% production tested at  $T_A = +25^{\circ}C$ . Limits over the operating temperature range are guaranteed through correlation using Statistical Quality Control (SQC) methods.

**Note 2:** Dropout voltage is defined as  $V_{IN} - V_{OUT}$ , when  $V_{OUT}$  is 100mV below the value of  $V_{OUT}$  for  $V_{IN} = V_{OUT} + 0.5V$ . Applies only for output voltages  $\geq 2.5V$ .

## Typical Operating Characteristics

(MAX8875EUK30,  $V_{IN} = +3.6V$ ,  $C_{IN} = C_{OUT} = 1\mu F$ ,  $\overline{SHDN} = IN$ ,  $T_A = +25^{\circ}C$ , unless otherwise noted.)

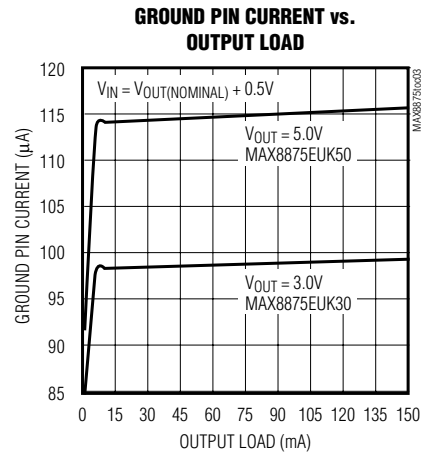
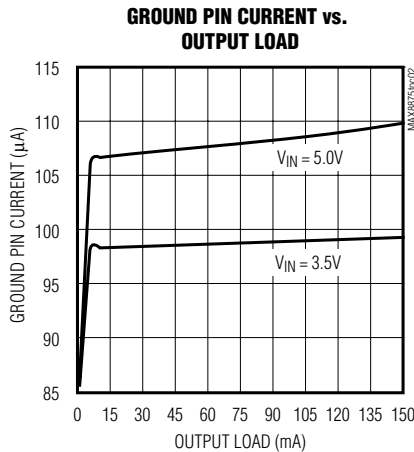
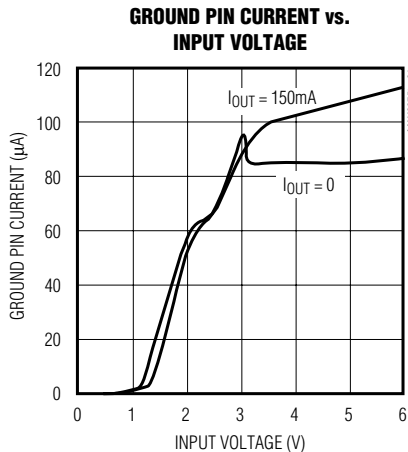

# 150mA, Low-Dropout Linear Regulator with Power-OK Output

## Typical Operating Characteristics (continued)

(MAX8875EUK30,  $V_{IN} = +3.6V$ ,  $C_{IN} = C_{OUT} = 1\mu F$ ,  $\overline{SHDN} = IN$ ,  $T_A = +25^\circ C$ , unless otherwise noted.)

**GROUND PIN CURRENT vs. TEMPERATURE**

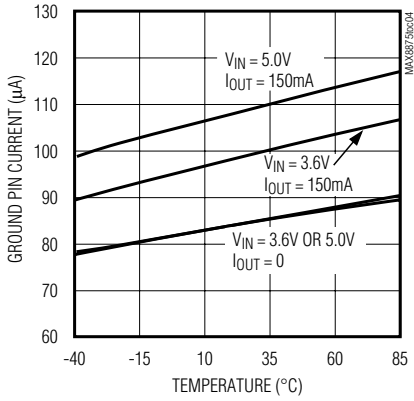

**OUTPUT VOLTAGE vs. INPUT VOLTAGE**

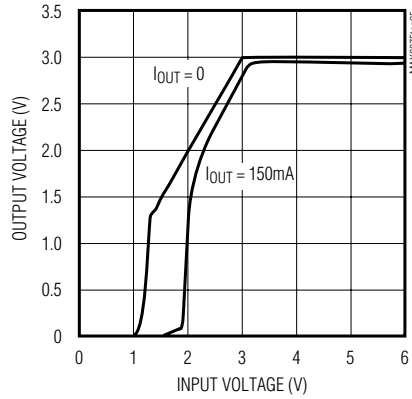

**OUTPUT VOLTAGE vs. OUTPUT LOAD**

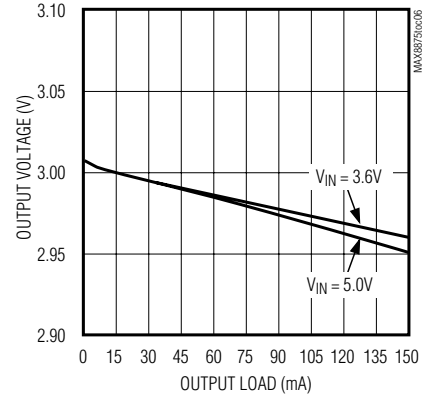

**OUTPUT VOLTAGE vs. TEMPERATURE**

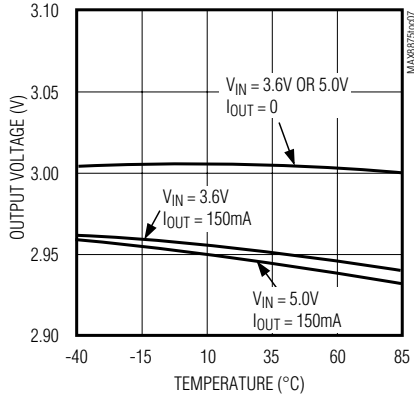

**DROPOUT VOLTAGE vs. OUTPUT LOAD**

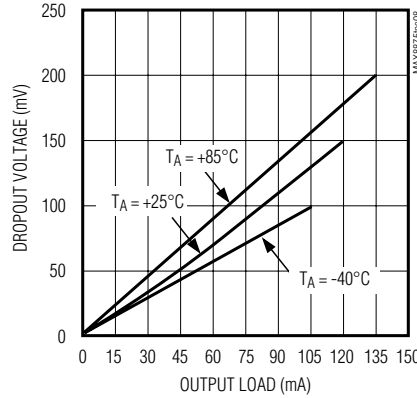

**POWER-SUPPLY REJECTION RATIO vs. FREQUENCY**

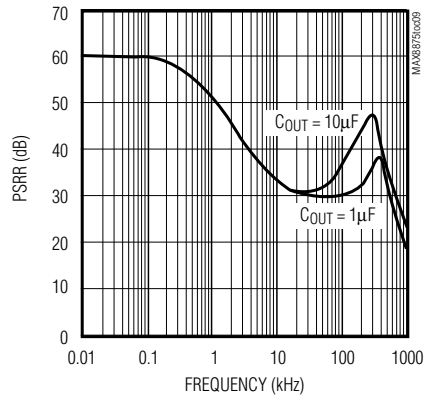

**OUTPUT NOISE SPECTRAL DENSITY vs. FREQUENCY**

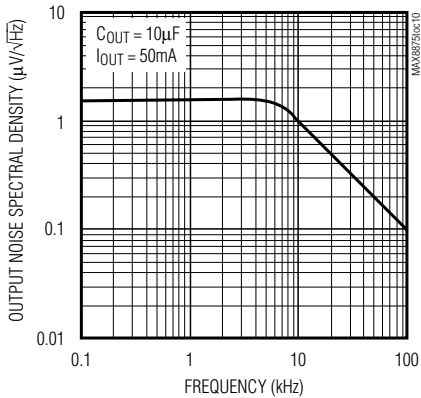

**OUTPUT NOISE**

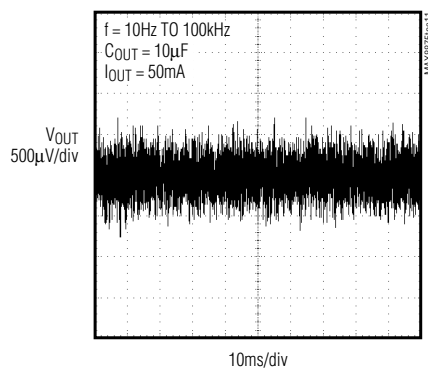

**LINE-TRANSIENT RESPONSE**

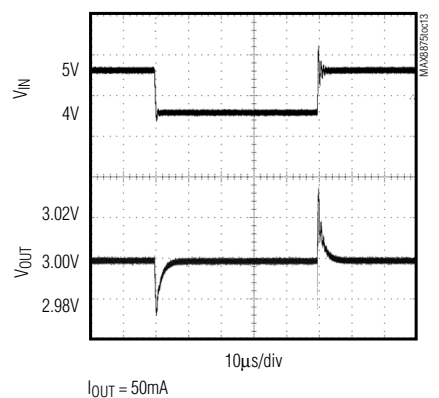

# 150mA, Low-Dropout Linear Regulator with Power-OK Output

MAX8875

## Typical Operating Characteristics (continued)

(MAX8875EUK30,  $V_{IN} = +3.6V$ ,  $C_{IN} = C_{OUT} = 1\mu F$ ,  $\overline{SHDN} = IN$ ,  $T_A = +25^\circ C$ , unless otherwise noted.)

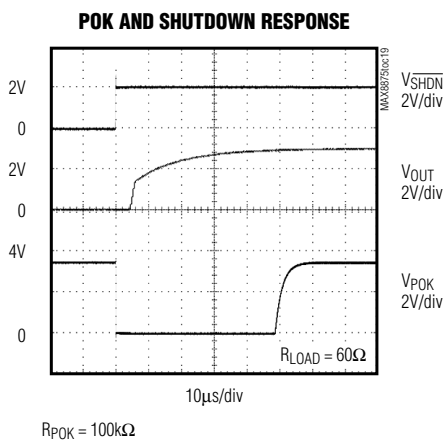
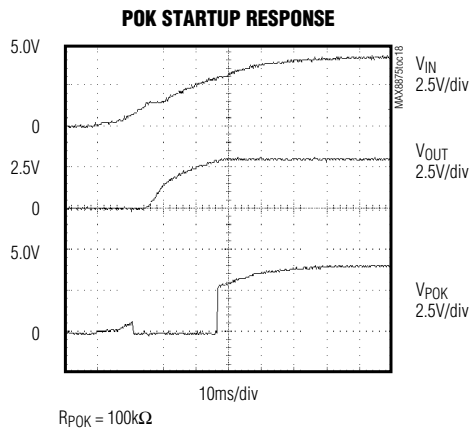
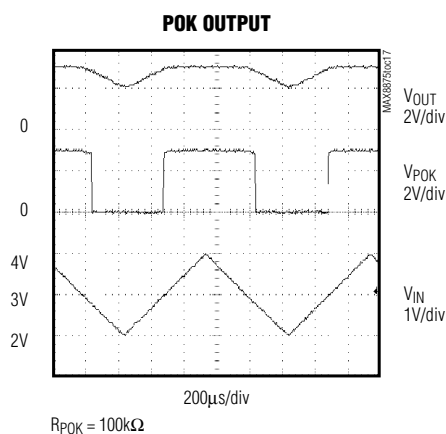
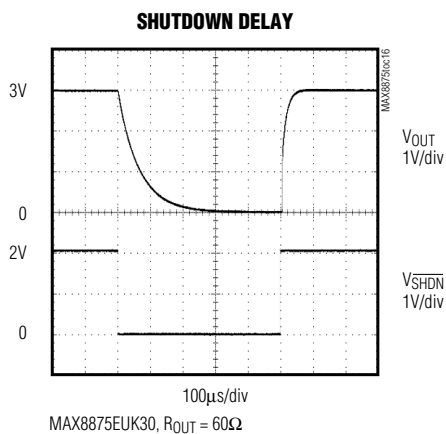
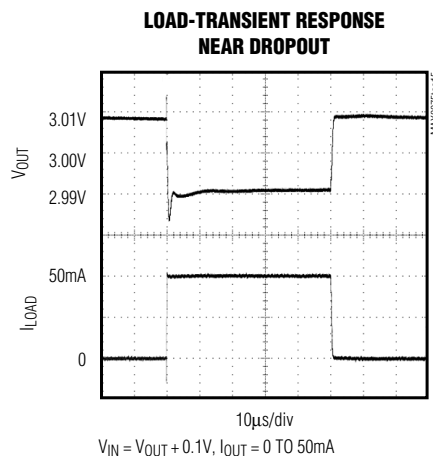
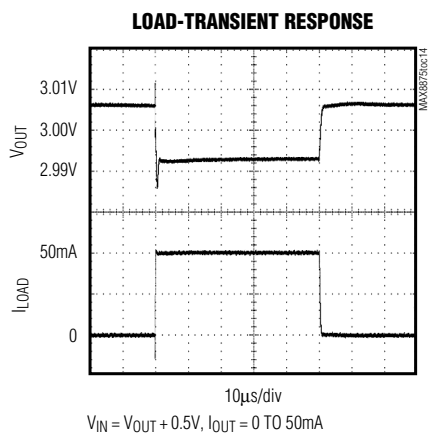

# 150mA, Low-Dropout Linear Regulator with Power-OK Output

## Pin Description

PIN	NAME	FUNCTION
1	IN	Regulator Input. Supply voltage can range from 2.5V to 6.5V. Bypass with 1 $\mu$ F to GND (see the <i>Capacitor Selection and Regulator Stability</i> section).
2	GND	Ground. This pin also functions as a heatsink. Solder to a large pad or the circuit-board ground plane to maximize power dissipation.
3	$\overline{\text{SHDN}}$	Active-Low Shutdown Input. A logic low reduces the supply current to below 1 $\mu$ A. Connect to IN for normal operation.
4	POK	Power-OK Output. Active-low, open-drain output indicates an out-of-regulation condition. Connect a 100k pull-up resistor to OUT for logic levels. If not used, leave this pin unconnected.
5	OUT	Regulator Output. Fixed 5.0V, 3.3V, 3.0V, 2.7V, 2.5V, or 1.5V output. Sources up to 150mA. Bypass with 1 $\mu$ F (<0.2 $\Omega$ typical ESR) ceramic capacitor to GND for $V_{\text{OUT}} \geq 2.5\text{V}$ . Bypass with 3.3 $\mu$ F (<0.2 $\Omega$ typ ESR) ceramic capacitor to GND for $V_{\text{OUT}} = 1.5\text{V}$ .

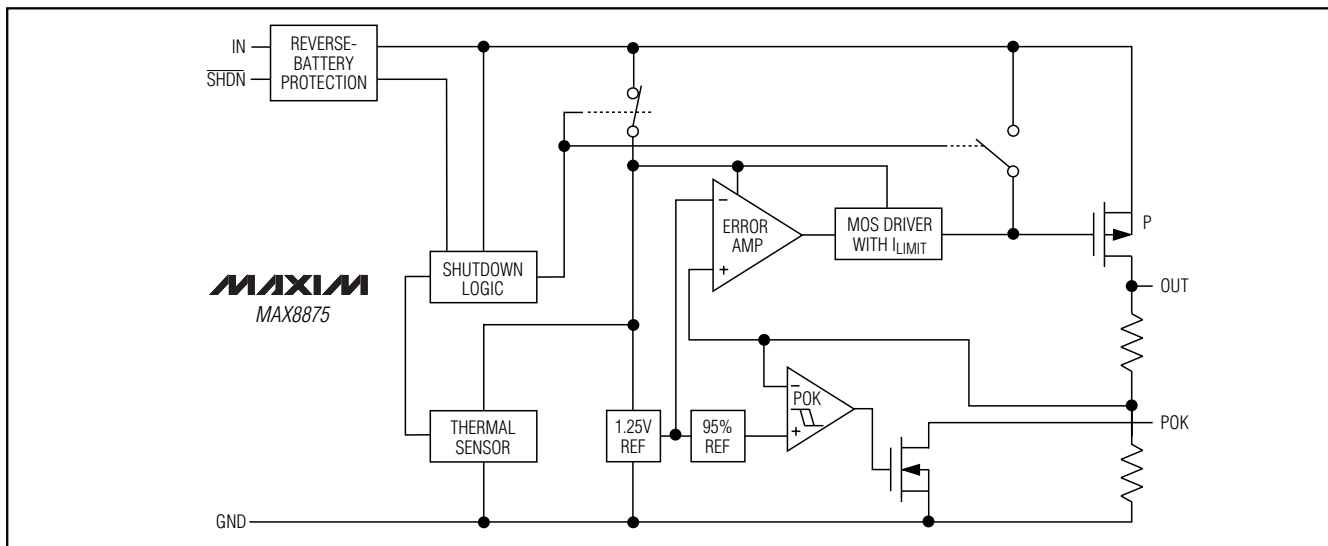

Figure 1. Functional Diagram

## Detailed Description

The MAX8875 is a low-dropout, low-quiescent-current linear regulator designed primarily for battery-powered applications. The device supplies loads up to 150mA and is available with preset output voltages of 1.5V, 2.5V, 2.7V, 3.0V, 3.3V, or 5.0V. As illustrated in Figure 1, the MAX8875 consists of a 1.25V reference, error amplifier, P-channel pass transistor, power-OK comparator, and internal feedback voltage divider.

The 1.25V bandgap reference is connected to the error amplifier's inverting input. The error amplifier compares

this reference with the feedback voltage and amplifies the difference. If the feedback voltage is lower than the reference voltage, the pass-transistor gate is pulled lower, which allows more current to pass to the output and increases the output voltage. If the feedback voltage is too high, the pass-transistor gate is pulled up, allowing less current to pass to the output. The output voltage feeds back through an internal resistor voltage divider connected to the OUT pin.

Additional blocks include a current limiter, reverse-battery protection, thermal sensor, and shutdown logic.

# 150mA, Low-Dropout Linear Regulator with Power-OK Output

## Output Voltage

The MAX8875 is supplied with factory-set output voltages of 1.5V, 2.5V, 2.7V, 3.0V, 3.3V, or 5.0V. The part number's two-digit suffix identifies the nominal output voltage. For example, the MAX8875EUK33 has a preset output voltage of 3.3V (see *Output Voltage Selector Guide*).

## Internal P-Channel Pass Transistor

The MAX8875 features a 1.1Ω (typ) P-channel MOSFET pass transistor. This provides several advantages over similar designs using PNP pass transistors, including longer battery life. The P-channel MOSFET requires no base drive, which reduces quiescent current significantly. PNP-based regulators waste considerable current in dropout when the pass transistor saturates. They also use high base-drive currents under large loads. The MAX8875 does not suffer from these problems and consumes only 100μA of quiescent current whether in dropout, light-load, or heavy-load applications (see *Typical Operating Characteristics*).

## Power-OK Output (POK)

When the output voltage goes out of regulation—as during dropout, current limit, or thermal shutdown—POK goes low. POK is an open-drain N-channel MOSFET. To obtain a logic-level output, connect a pull-up resistor from POK to OUT. To minimize current consumption, make this resistor as large as practical. A 100kΩ resistor works well for most applications. A capacitor to GND may be added to generate a power-on-reset (POR) delay. The POK function is not active during shutdown. POK also provides a power-on-reset function that can operate down to  $V_{IN} \leq 1V$ . See POK Startup Response in the *Typical Operating Characteristics*.

## Current Limit

The MAX8875 includes a current limiter that monitors and controls the pass transistor's gate voltage, limiting the output current to 390mA (typ). For design purposes, consider the current limit to be 160mA min to 600mA max. The output can be shorted to ground for an indefinite period of time without damaging the part.

## Thermal-Overload Protection

When the junction temperature exceeds  $T_J = +170^\circ\text{C}$ , the thermal sensor signals the shutdown logic, turning off the pass transistor and allowing the IC to cool. The thermal sensor will turn the pass transistor on again after the IC's junction temperature cools by 20°C, resulting in a pulsed output during continuous thermal-overload conditions. Thermal-overload protection is designed to protect the MAX8875 in the event of fault conditions. For

continuous operation, do not exceed the absolute maximum junction-temperature rating of  $T_J = +150^\circ\text{C}$ .

## Operating Region and Power Dissipation

The MAX8875's maximum power dissipation depends on the thermal resistance of the case and circuit board, the temperature difference between the die junction and ambient air, and the rate of air flow. The power dissipation across the device is  $P = I_{OUT}(V_{IN} - V_{OUT})$ . The maximum power dissipation is:

$$P_{MAX} = (T_J - T_A) / (\theta_{JB} + \theta_{BA})$$

where  $T_J - T_A$  is the temperature difference between the MAX8875 die junction and the surrounding air,  $\theta_{JB}$  (or  $\theta_{JC}$ ) is the thermal resistance of the package, and  $\theta_{BA}$  is the thermal resistance through the printed circuit board, copper traces, and other materials to the surrounding air.

The MAX8875's ground pin (GND) performs the dual function of providing an electrical connection to system ground and channeling heat away. Connect GND to the system ground using a large pad or ground plane.

## Reverse-Battery Protection

The MAX8875 has a unique protection scheme that limits the reverse supply current to 1mA when either  $V_{IN}$  or  $V_{SHDN}$  falls below ground. The circuitry monitors the polarity of these two pins and disconnects the internal circuitry and parasitic diodes when the battery is reversed. This feature prevents device damage.

## Applications Information

### Capacitor Selection and Regulator Stability

For stable operation over the full temperature range and with load currents up to 150mA, use a 1μF (min) ceramic output capacitor with an ESR  $< 0.2\Omega$  for  $V_{OUT} \geq 2.5V$ , or an equivalent 3.3μF ceramic output capacitor for  $V_{OUT} = 1.5V$ . To reduce noise and improve load-transient response, stability, and power-supply rejection, use large output capacitor values, such as 10μF.

Note that some ceramic dielectrics exhibit large capacitance and ESR variation with temperature. With dielectrics such as Z5U and Y5V, it may be necessary to increase the capacitance by a factor of 2 or more to ensure stability at temperatures below  $T_A = -10^\circ\text{C}$ . With X7R or X5R dielectrics, 1μF should be sufficient at all operating temperatures for  $V_{OUT} \geq 2.5V$ . For a pin-compatible, functionally equivalent device for use with a higher ESR output capacitor, see the MAX8885.

# 150mA, Low-Dropout Linear Regulator with Power-OK Output

## **PSRR and Operation from Sources Other than Batteries**

The MAX8875 is designed to deliver low dropout voltages and low quiescent currents in battery-powered systems. Power-supply rejection is 60dB at low frequencies. See the Power-Supply Rejection Ratio vs. Frequency graph in the *Typical Operating Characteristics*.

Improve supply-noise rejection and transient response by increasing the values of the input and output bypass capacitors. The *Typical Operating Characteristics* show the MAX8875's line- and load-transient responses.

## **Dropout Voltage**

For versions with the output voltage greater than the minimum input voltage (2.5V), the regulator's minimum input-output voltage differential (or dropout voltage) determines the lowest usable supply voltage. In battery-powered systems, this will determine the useful end-of-life battery voltage. Because the MAX8875 uses a P-channel MOSFET pass transistor, its dropout voltage is a function of drain-to-source on-resistance ( $R_{DS(ON)}$ ) multiplied by the load current (see *Typical Operating Characteristics*):

$$V_{DROPOUT} = V_{IN} - V_{OUT} = R_{DS(ON)} \times I_{OUT}$$

---

## **Chip Information**

TRANSISTOR COUNT: 266



# 150mA, Low-Dropout Linear Regulator with Power-OK Output

## Package Information

**MAX8875**

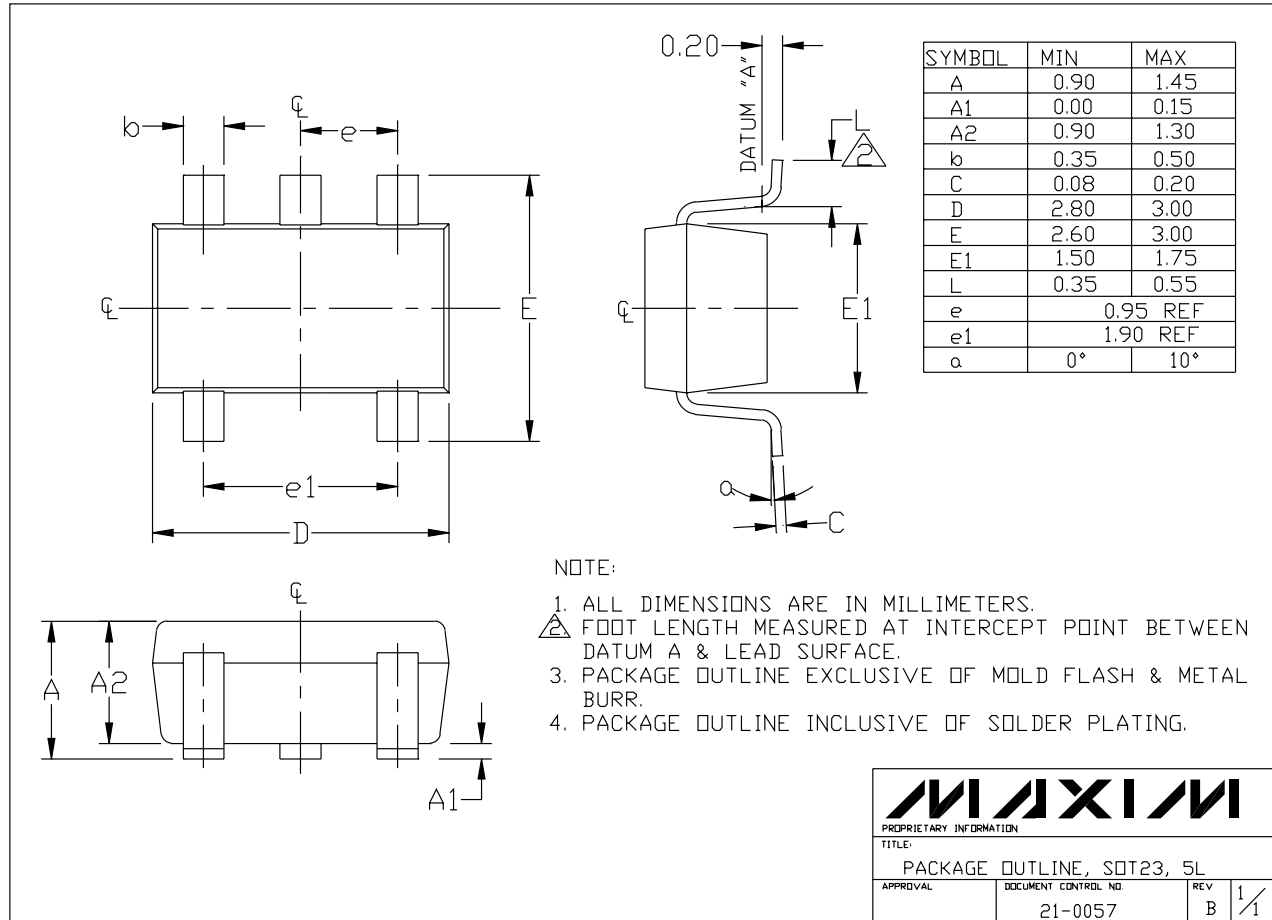

SOT23LEP5

Maxim cannot assume responsibility for use of any circuitry other than circuitry entirely embodied in a Maxim product. No circuit patent licenses are implied. Maxim reserves the right to change the circuitry and specifications without notice at any time.

9 **Maxim Integrated Products, 120 San Gabriel Drive, Sunnyvale, CA 94086 408-737-7600**

# Mouser Electronics

Authorized Distributor

Click to View Pricing, Inventory, Delivery & Lifecycle Information:

[Maxim Integrated:](#)

[MAX8875EUK25+T](#) [MAX8875EUK27+T](#) [MAX8875EUK30+T](#) [MAX8875EUK33+T](#) [MAX8875EUK50+T](#)  
[MAX8875EUK27-T](#) [MAX8875EUK30-T](#) [MAX8875EUK33-T](#) [MAX8875EUK50-T](#)