

Voltage selector switch, 6 stages, serie-parallel, panel mounting



See below:

**Approvals and Compliances**

**Description**

- Voltage Selector , 6 stages
- Series-parallel connections
- Solder terminals

**References**

Alternative: version for PCB mounting [SWZ2 \(Print\)](#)

**Weblinks**

[pdf data sheet](#), [html datasheet](#), [General Product Information](#), [Approvals](#), [Distributor-Stock-Check](#), [Detailed request for product](#)

**Technical Data**

Ratings	IEC: 6.3 A / 250 VAC; 50 Hz
	UL: 10 A / 250 VAC; 60 Hz
	CSA: 6.3 A / 250 VAC; 60 Hz
Mounting	Panel mount from front side
Attachment	Screw-on mounting
Terminal	Solder
Number of Stages	6
Lifetime	300 operating cycles (without load)
Degree of Protection	IP40
Protection Class	Suitable for appliances with protection class II acc. to IEC 61140
Allowable Operation Temperature	-40 °C to 85 °C
Climatic Category	25/85/21 acc. to IEC 60068-1
Material: Socket	Thermoplastic, black, UL 94V-0
Weight	12.4 g

Solderability	350 °C / 2 sec acc. to IEC 60068-2-20, Test Ta, method 2
Resistance to Soldering Heat	350 °C / 10sec acc. to IEC 60068-2-20, Test Tb, method 2
Insulation Resistance	> 10'000MΩ (500VDC; 1min)
Contact Resistance	< 10 mΩ at 20 mV
Dielectric Strength	> 2kVAC between L-N
	> 4kVAC between L/N-PE (1min; 50Hz)
Clearance and Creepage Distance	> 3mm
	> 8mm between L/N-PE
Resistance to Vibration	acc. to IEC 60068-2-6, test Fc
Panel Thickness S	max 4 mm

**Approvals and Compliances**

Detailed information on product approvals, code requirements, usage instructions and detailed test conditions can be looked up in [Details about Approvals](#)

SCHURTER products are designed for use in industrial environments. They have approvals from independent testing bodies according to national and international standards. Products with specific characteristics and requirements such as required in the automotive sector according to IATF 16949, medical technology according to ISO 13485 or in the aerospace industry can be offered exclusively with customer-specific, individual agreements by SCHURTER.

**Approvals**



The approval mark is used by the testing authorities to certify compliance with the safety requirements placed on electronic products.

Approval Reference Type: SWZ

Approval Logo	Certificates	Certification Body	Description
	<a href="#">VDE Approvals</a>	VDE	Certificate Number:
	<a href="#">UL Approvals</a>	UL	UL File Number: E72661
	<a href="#">CSA Approvals</a>	CSA	CSA Certification Record: LR45945

## Product standards

Product standards that are referenced

Organization	Design	Standard	Description
	Designed according to	UL 508	Industrial control equipment
	Designed according to	CSA C22.2 no. 55	Fuseholder general requirements



## Application standards

Application standards where the product can be used

Organization	Design	Standard	Description
	Designed for applications acc.	IEC/UL 62368-1	IEC 62368-1 includes the basic requirements for safety of audio, video, information technology and office equipment.

## Compliances

The product complies with following Guide Lines

Identification	Details	Initiator	Description
	<a href="#">CE declaration of conformity</a>	SCHURTER AG	The CE marking declares that the product complies with the applicable requirements laid down in the harmonisation of Community legislation on its affixing in accordance with EU Regulation 765/2008.
	<a href="#">REACH</a>	SCHURTER AG	On 1 June 2007, Regulation (EC) No 1907/2006 on the Registration, Evaluation, Authorization and Restriction of Chemicals 1 (abbreviated as "REACH") entered into force.

## Dimension [mm]

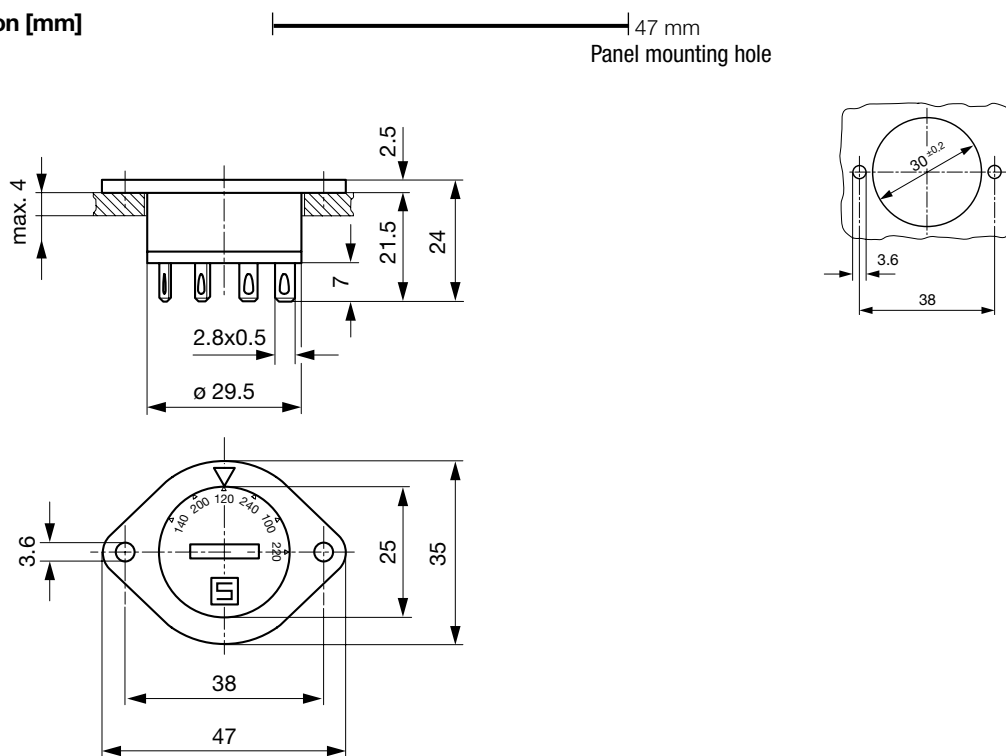

Diagrams

Reverse view

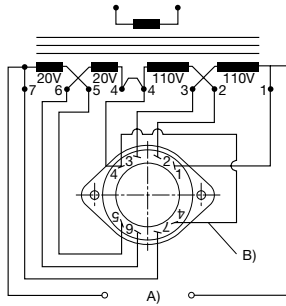

- A) Power mains
- B) External connection

All Variants

Letterings						Order Number
Stage 1	Stage 2	Stage 3	Stage 4	Stage 5	Stage 6	
150	220	130	260	110	240	0033.3501
	220	120	240	110		0033.3502
	115	230				0033.3503
130	220	120	240	110	230	0033.3504
140	200	120	240	100	220	0033.3505
127	200	115	240	100	220	0033.3510
						0033.3514
	220	130		110	240	0033.3518
		110	220			0033.3522
0	220	120	0	100	230/240	0033.3527
100	240		220	120		0033.3530
130	200	115	230	100	215	0033.3539
	200	120	240	100		0033.3547
100	0	117	220	100	240	0033.3549
140	200	120	240	100	230	0033.3553
		120	240	100	220	0033.3555
140	200	120	230/240	100	220/230	0033.3558
127	220	115	240	110	230	0033.3560

Most Popular.

Availability for all products can be searched real-time: <https://www.schurter.com/en/Stock-Check/Stock-Check-SCHURTER>

Packaging Unit 25 Pcs