

## Product Summary

Part Number	R1 (NOM)	R2 (NOM)	Marking
DDTC123JLP	2.2kΩ	47kΩ	N0
DDTC143ZLP	4.7kΩ	47kΩ	N1
DDTC114YLP	10kΩ	47kΩ	N2

## Features

- Epitaxial Planar Die Construction
- Ultra-Small Leadless Surface Mount Package
- Ideally Suited for Automated Assembly Processes
- **Totally Lead-Free & Fully RoHS Compliant (Notes 1 & 2)**
- **Halogen and Antimony Free. "Green" Device (Note 3)**
- **Qualified to AEC-Q101 Standards for High Reliability**

## Mechanical Data

- Case: X1-DFN1006-3
- Case Material: Molded Plastic, "Green" Molding Compound. UL Flammability Classification Rating 94V-0
- Moisture Sensitivity: Level 1 per J-STD-020
- Terminal Connections: See Marking Information
- Terminals: Finish — NiPdAu Solderable per MIL-STD-202, Method 208<sup>(e4)</sup>
- Weight: 0.0009 grams (Approximate)

X1-DFN1006-3

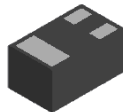

Bottom View

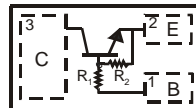

Package Pin Out Configuration

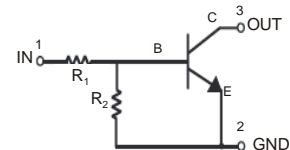
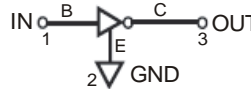

Device Schematics

## Ordering Information (Note 4)

Part Number	Marking	Reel size (inches)	Tape width (mm)	Quantity per reel
DDTC123JLP-7	N0	7	8	3,000
DDTC143ZLP-7	N1	7	8	3,000
DDTC114YLP-7	N2	7	8	3,000
DDTC123JLP-7B	N0	7	8	10,000
DDTC143ZLP-7B	N1	7	8	10,000
DDTC114YLP-7B	N2	7	8	10,000

- Notes:
1. No purposely added lead. Fully EU Directive 2002/95/EC (RoHS) & 2011/65/EU (RoHS 2) compliant.
  2. See [http://www.diodes.com/quality/lead\\_free.html](http://www.diodes.com/quality/lead_free.html) for more information about Diodes Incorporated's definitions of Halogen- and Antimony-free, "Green" and Lead-free.
  3. Halogen- and Antimony-free "Green" products are defined as those which contain <900ppm bromine, <900ppm chlorine (<1500ppm total Br + Cl) and <1000ppm antimony compounds.
  4. For packaging details, go to our website at <http://www.diodes.com/products/packages.html>.

## Marking Information

<p>DDTC123JLP-7 DDTC143ZLP-7 DDTC114YLP-7</p>	<div style="display: flex; justify-content: space-around;"> <div style="text-align: center;"> <p>Top View Dot Denotes Collector Side</p> </div> <div style="text-align: center;"> <p>From date code 1527 (YYWW), this changes to:</p> <p>Top View Bar Denotes Base and Emitter Side</p> </div> </div>
<p>DDTC123JLP-7B DDTC143ZLP-7B DDTC114YLP-7B</p>	<div style="text-align: center;"> <p>Top View Bar Denotes Base and Emitter Side</p> </div> <p style="text-align: right;">Nx = Part Type Marking Code (see Ordering Information)</p>

**Absolute Maximum Ratings** (@T<sub>A</sub> = +25°C, unless otherwise specified.)

Characteristic	P/N	Symbol	Value	Unit
Supply Voltage		V <sub>CC</sub>	50	V
Input Voltage	DDTC123JLP	V <sub>IN</sub>	-5 to +12	V
	DDTC143ZLP		-5 to +30	
	DDTC114YLP		-5 to +40	
Output Voltage	DDTC123JLP	I <sub>O</sub>	100	mA
	DDTC143ZLP		100	
	DDTC114YLP		70	
Maximum Collector Current		I <sub>C(MAX)</sub>	100	mA

**Thermal Characteristics**

Characteristic	Symbol	Value	Unit
Power Dissipation (Note 5)	P <sub>D</sub>	250	mW
Power Deration above +25°C	P <sub>der</sub>	2	mW/°C
Thermal Resistance, Junction to Ambient Air (Note 5)	R <sub>θJA</sub>	500	°C/W
Operating and Storage Temperature Range	T <sub>J</sub> , T <sub>STG</sub>	-55 to +150	°C

**Electrical Characteristics** (@T<sub>A</sub> = +25°C, unless otherwise specified.)

Characteristic	P/N	Symbol	Min	Typ	Max	Unit	Test Condition
<b>Off Characteristics</b> (Note 6)							
Collector-Base Breakdown Voltage		BV <sub>CB0</sub>	50	—	—	V	I <sub>C</sub> = 50μA, I <sub>E</sub> = 0
Collector-Emitter Breakdown Voltage (Note 7)		BV <sub>CEO</sub>	50	—	—	V	I <sub>C</sub> = 2mA, I <sub>B</sub> = 0
Emitter-Base Breakdown Voltage (Note 7)		BV <sub>EBO</sub>	4.5	—	—	V	I <sub>E</sub> = 50μA, I <sub>C</sub> = 0
Collector Cutoff Current (Note 7)		I <sub>CEX</sub>	—	—	0.5	μA	V <sub>CE</sub> = 50V, V <sub>EB(OFF)</sub> = 3.0V
Base Cutoff Current (I <sub>BEX</sub> )		I <sub>BL</sub>	—	—	0.5	μA	V <sub>CE</sub> = 50V, V <sub>EB(OFF)</sub> = 3.0V
Collector-Base Cut Off Current		I <sub>CBO</sub>	—	—	0.5	μA	V <sub>CB</sub> = 50V, I <sub>E</sub> = 0
Collector-Emitter Cut Off Current, I <sub>O(OFF)</sub>		I <sub>CEO</sub>	—	—	0.5	μA	V <sub>CE</sub> = 50V, I <sub>B</sub> = 0
Emitter-Base Cut Off Current		I <sub>EBO</sub>	—	—	0.5	mA	V <sub>EB</sub> = 5V, I <sub>C</sub> = 0
Input-Off Voltage		V <sub>I(OFF)</sub>	0.5	—	—	V	V <sub>CE</sub> = 5V, I <sub>C</sub> = 100μA
<b>On Characteristics</b> (Note 6)							
Base-Emitter Turn-On Voltage (Note 7)	DDTC123JLP	V <sub>BE(ON)</sub>	—	—	0.85	V	V <sub>CE</sub> = 5V, I <sub>C</sub> = 2mA
	DDTC143ZLP		—	—	0.85		
	DDTC114YLP		—	—	0.95		
Base-Emitter Saturation Voltage (Note 7)	DDTC123JLP	V <sub>BE(SAT)</sub>	—	—	0.98	V	I <sub>C</sub> = 10mA, I <sub>B</sub> = 1mA
	DDTC143ZLP		—	—	0.998		
	DDTC114YLP		—	—	0.98		
Input-On Voltage		V <sub>I(ON)</sub>	—	—	1.1	V	V <sub>O</sub> = 0.3V, I <sub>C</sub> = 5mA
Input Current	DDTC123JLP	I <sub>I</sub>	—	—	7.2	mA	V <sub>I</sub> = 5V
	DDTC143ZLP		—	—	1.5		
	DDTC114YLP		—	—	7.2		
DC Current Gain		h <sub>FE</sub>	50	—	—	—	V <sub>CE</sub> = 5V, I <sub>C</sub> = 1mA
			70	—	—	—	V <sub>CE</sub> = 5V, I <sub>C</sub> = 2mA
			125	—	—	—	V <sub>CE</sub> = 5V, I <sub>C</sub> = 5mA
			150	—	—	—	V <sub>CE</sub> = 5V, I <sub>C</sub> = 10mA
			180	—	—	—	V <sub>CE</sub> = 5V, I <sub>C</sub> = 50mA
Collector-Emitter Saturation Voltage		V <sub>CE(SAT)</sub>	—	—	0.15	V	I <sub>C</sub> = 10mA, I <sub>B</sub> = 1mA
			—	—	0.2	V	I <sub>C</sub> = 50mA, I <sub>B</sub> = 5mA
Output On Voltage (Same as V <sub>CE(SAT)</sub> )		V <sub>O(ON)</sub>	—	—	0.3		I <sub>J</sub> = 2.5mA, I <sub>O</sub> = 50mA
Input Resistor +/-30%		ΔR1	-30	—	30	%	—
Resistor Ratio		Δ (R2/R1)	-20	—	-20	%	—
<b>Small Signal Characteristics</b>							
Transition Frequency (gain bandwidth product)		f <sub>T</sub>	—	250	—	MHz	V <sub>CE</sub> = 10V, I <sub>E</sub> = 5mA, f = 100MHz

- Notes:
5. For the device mounted on minimum recommended pad layout 1oz copper that is on a single-sided 1.6mm FR4 PCB; device is measured under still air conditions whilst operating in steady state condition. The entire exposed collector pad is attached to the heatsink.
  6. Measured under pulsed conditions. Pulse width ≤ 300μs. Duty cycle ≤ 2%.
  7. Guaranteed by design.

**Derating Curve** (@T<sub>A</sub> = +25°C, unless otherwise specified.)

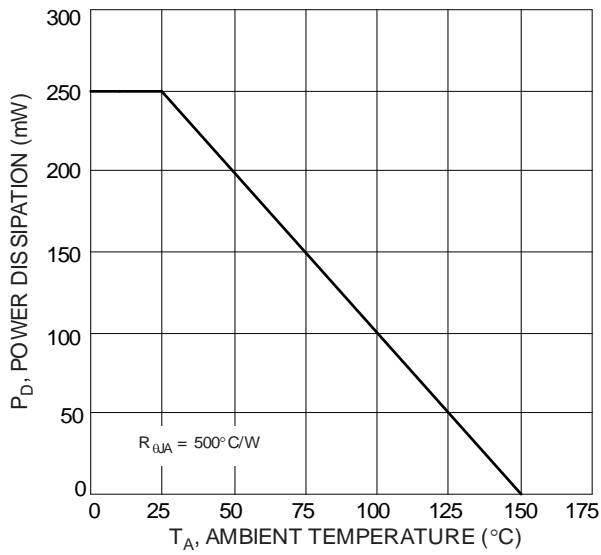

Fig. 1 Power Dissipation vs. Ambient temperature  
(Note 5)

**Typical Electrical Characteristics of DDTC123JLP** (@ $T_A = +25^\circ\text{C}$ , unless otherwise specified.)

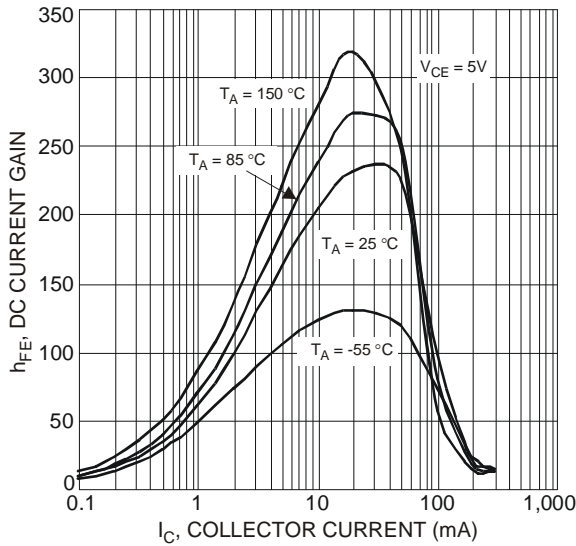

Fig. 2 Typical DC Current Gain vs. Collector Current

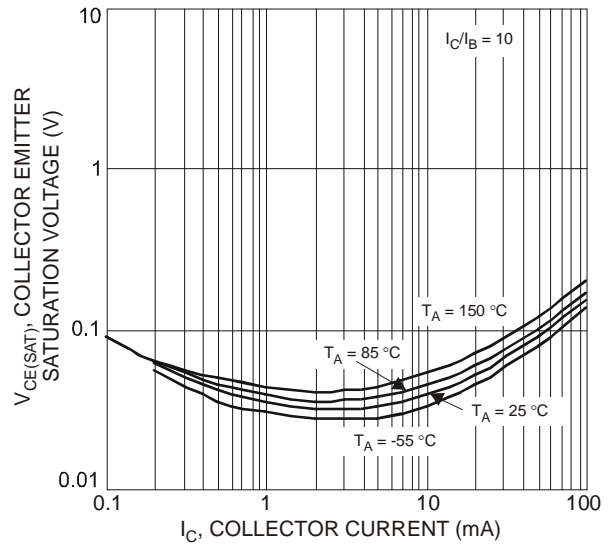

Fig. 3 Typical Collector Emitter Saturation Voltage vs. Collector Current

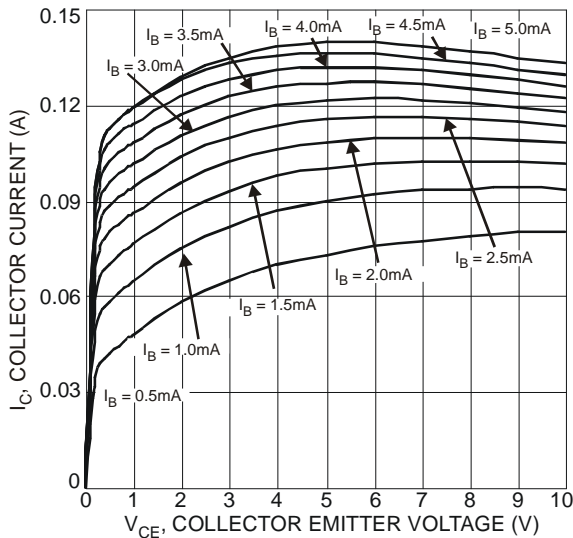

Fig. 4 Typical Collector Current vs. Collector Emitter Voltage

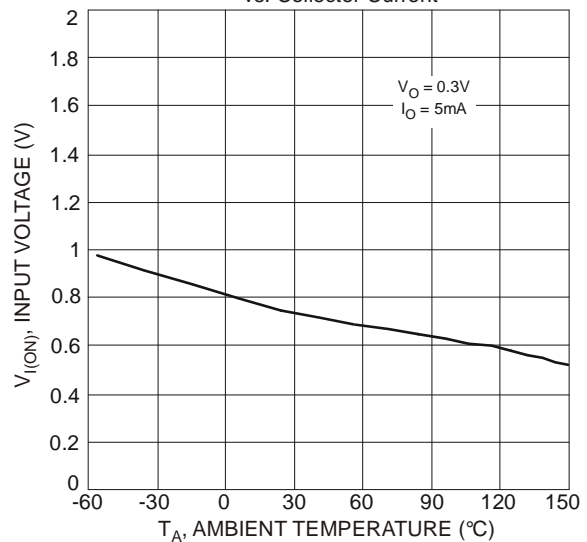

Fig. 5 Typical Input Voltage vs. Ambient Temperature

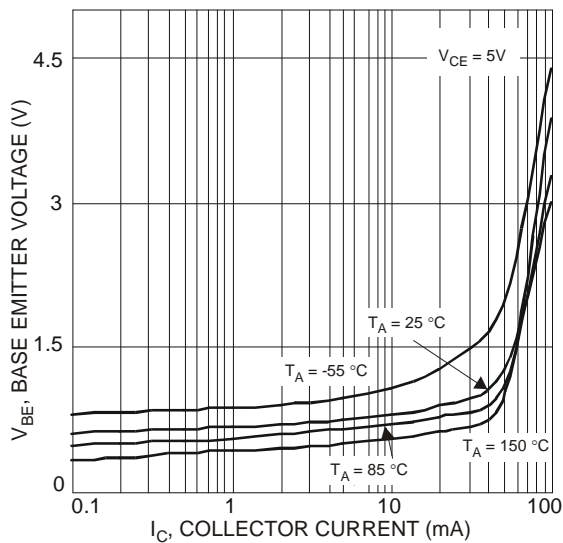

Fig. 6 Typical Base Emitter Voltage vs. Collector Current

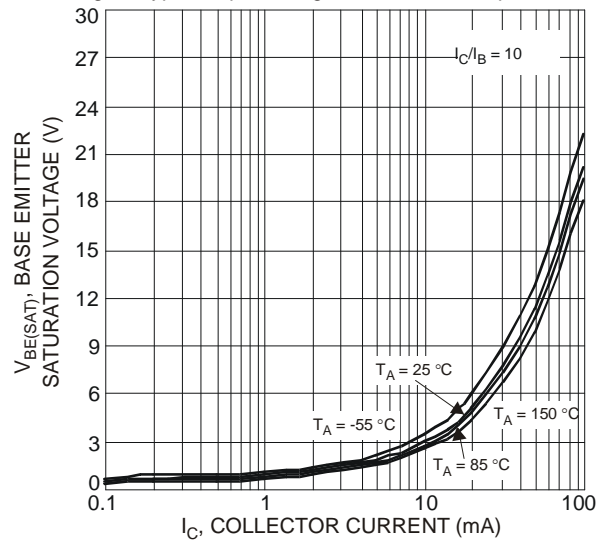

Fig. 7 Typical Base Emitter Saturation Voltage vs. Collector Current

**Typical Electrical Characteristics of DDTC143ZLP (@T<sub>A</sub> = +25°C, unless otherwise specified.)**

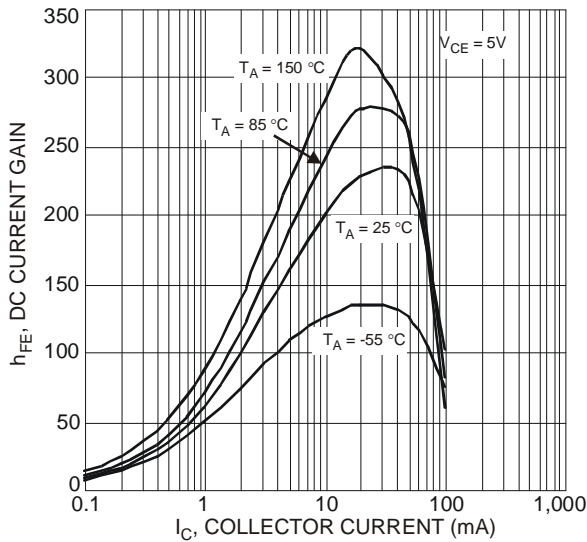

Fig. 8 Typical DC Current Gain vs. Collector Current

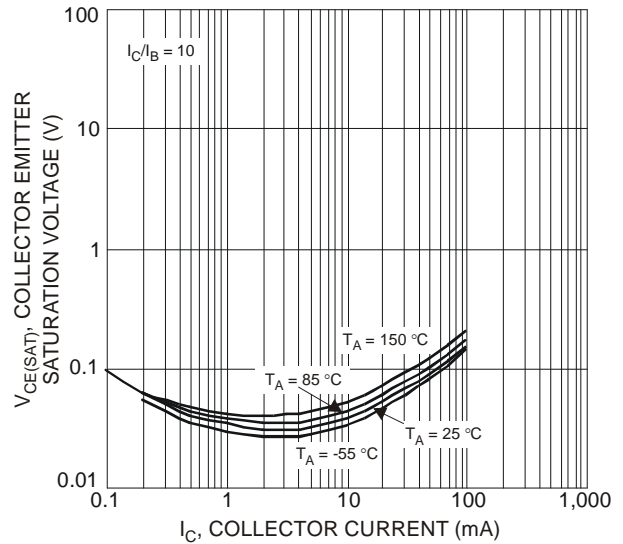

Fig. 9 Typical Collector Emitter Saturation Voltage vs. Collector Current

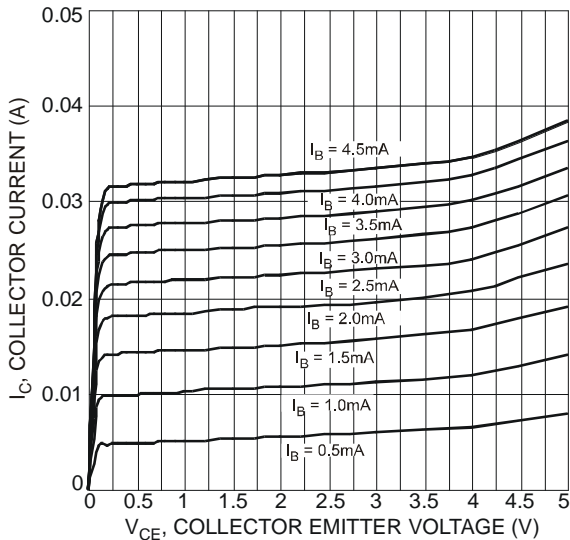

Fig. 10 Typical Collector Current vs. Collector Emitter Voltage

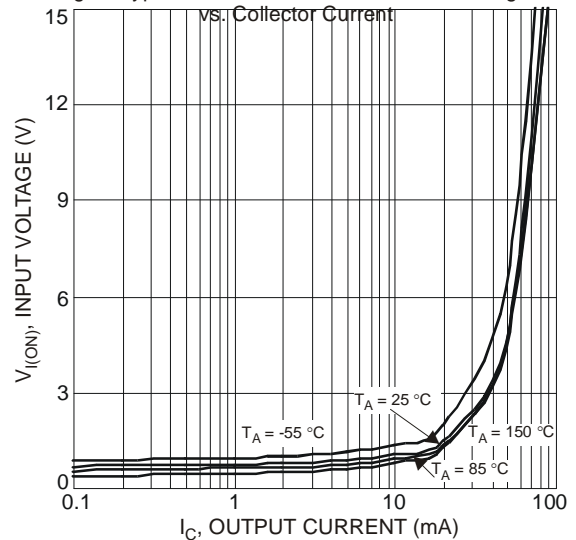

Fig. 11 Typical Input Voltage vs. Output Current

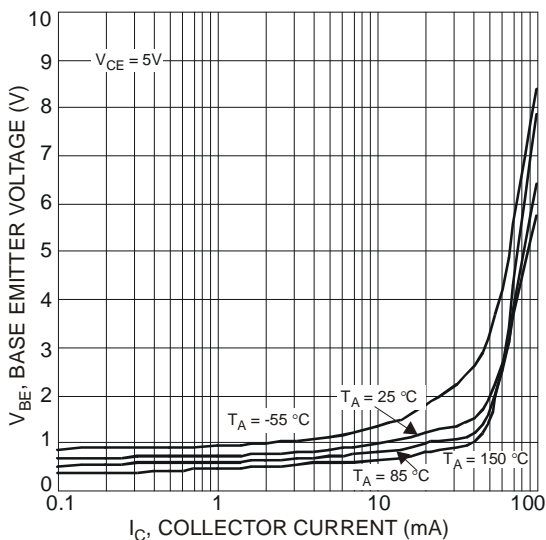

Fig. 12 Typical Base Emitter Voltage vs. Collector Current

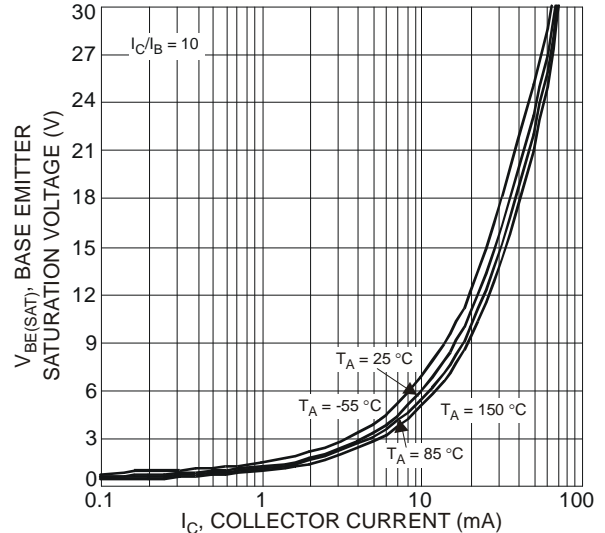

Fig. 13 Typical Base Emitter Saturation Voltage vs. Collector Current

**Typical Electrical Characteristics of DDTC114YLP (@T<sub>A</sub> = +25°C, unless otherwise specified.)**

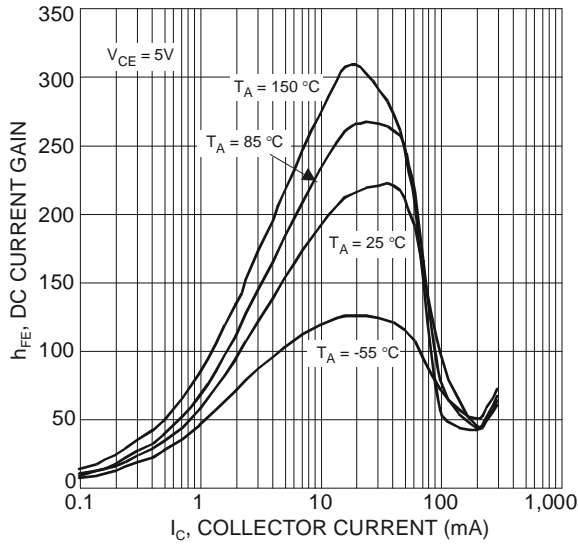

Fig. 14 Typical DC Current Gain vs. Collector Current

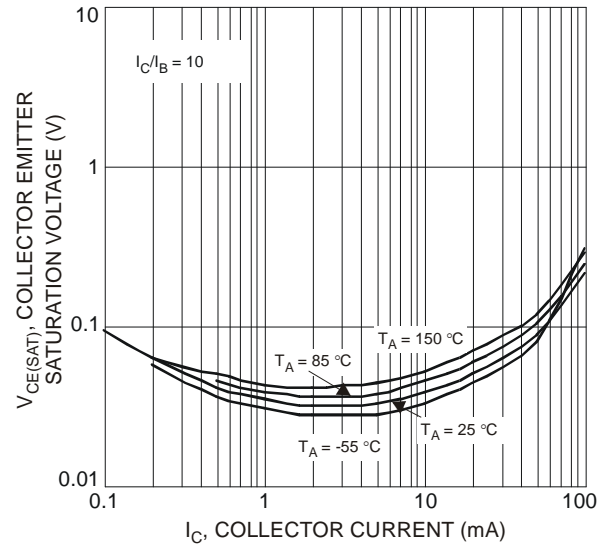

Fig. 15 Typical Collector Emitter Saturation Voltage vs. Collector Current

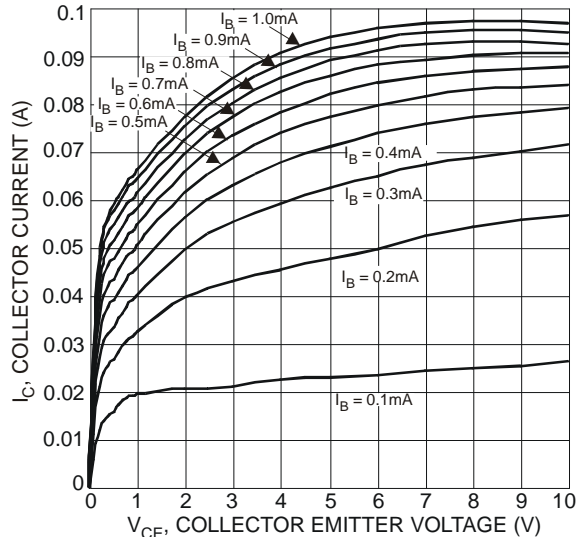

Fig. 16 Typical Collector Current vs. Collector Emitter Voltage

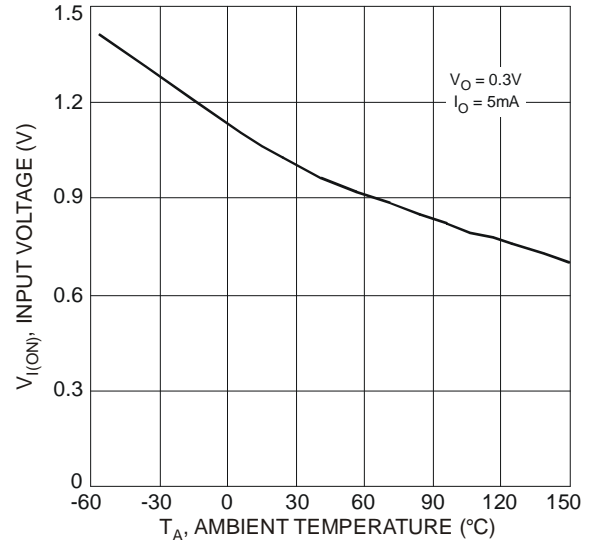

Fig. 17 Typical Input Voltage vs. Ambient Temperature

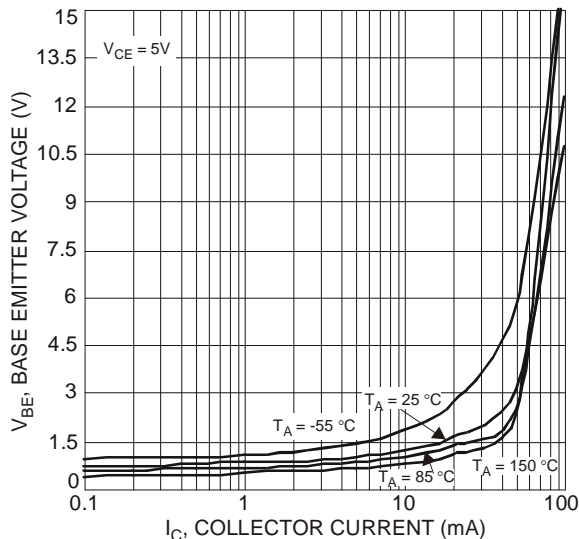

Fig. 18 Typical Base Emitter Voltage vs. Collector Current

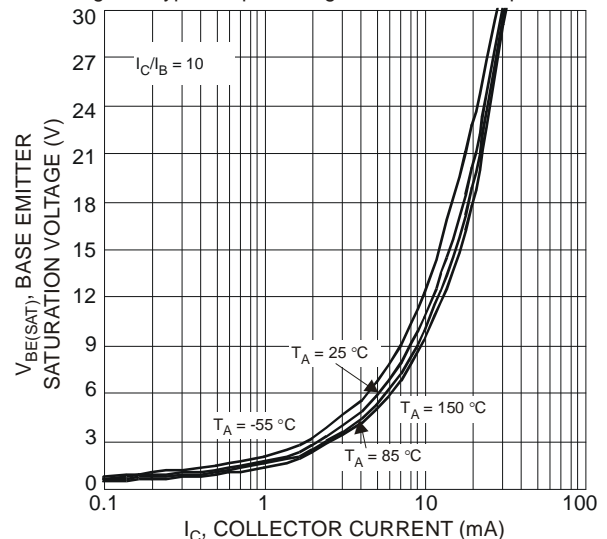
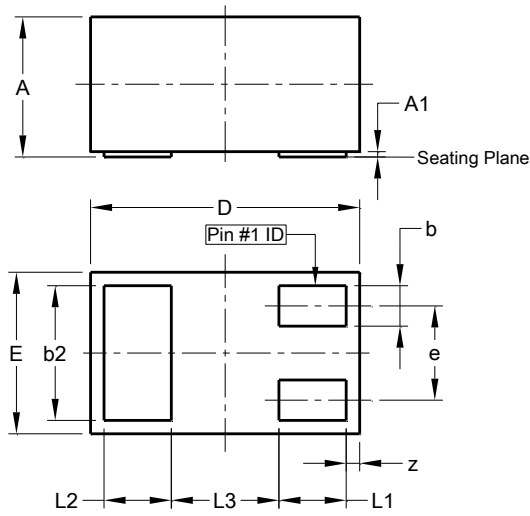

Fig. 19 Typical Base Emitter Saturation Voltage vs. Collector Current

**Package Outline Dimensions**

Please see AP02001 at [http://www.diodes.com/\\_files/datasheets/ap02001.pdf](http://www.diodes.com/_files/datasheets/ap02001.pdf) for the latest version.



X1-DFN1006-3			
Dim	Min	Max	Typ
A	0.47	0.53	0.50
A1	0.00	0.05	0.03
b	0.10	0.20	0.15
b2	0.45	0.55	0.50
D	0.95	1.075	1.00
E	0.55	0.675	0.60
e	-	-	0.35
L1	0.20	0.30	0.25
L2	0.20	0.30	0.25
L3	-	-	0.40
z	0.02	0.08	0.05
All Dimensions in mm			

**Suggested Pad Layout**

Please see AP02001 at [http://www.diodes.com/\\_files/datasheets/ap02001.pdf](http://www.diodes.com/_files/datasheets/ap02001.pdf) for the latest version.

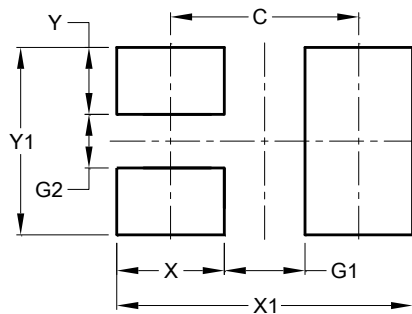

Dimensions	Value (in mm)
C	0.70
G1	0.30
G2	0.20
X	0.40
X1	1.10
Y	0.25
Y1	0.70

**IMPORTANT NOTICE**

DIODES INCORPORATED MAKES NO WARRANTY OF ANY KIND, EXPRESS OR IMPLIED, WITH REGARDS TO THIS DOCUMENT, INCLUDING, BUT NOT LIMITED TO, THE IMPLIED WARRANTIES OF MERCHANTABILITY AND FITNESS FOR A PARTICULAR PURPOSE (AND THEIR EQUIVALENTS UNDER THE LAWS OF ANY JURISDICTION).

Diodes Incorporated and its subsidiaries reserve the right to make modifications, enhancements, improvements, corrections or other changes without further notice to this document and any product described herein. Diodes Incorporated does not assume any liability arising out of the application or use of this document or any product described herein; neither does Diodes Incorporated convey any license under its patent or trademark rights, nor the rights of others. Any Customer or user of this document or products described herein in such applications shall assume all risks of such use and will agree to hold Diodes Incorporated and all the companies whose products are represented on Diodes Incorporated website, harmless against all damages.

Diodes Incorporated does not warrant or accept any liability whatsoever in respect of any products purchased through unauthorized sales channel. Should Customers purchase or use Diodes Incorporated products for any unintended or unauthorized application, Customers shall indemnify and hold Diodes Incorporated and its representatives harmless against all claims, damages, expenses, and attorney fees arising out of, directly or indirectly, any claim of personal injury or death associated with such unintended or unauthorized application.

Products described herein may be covered by one or more United States, international or foreign patents pending. Product names and markings noted herein may also be covered by one or more United States, international or foreign trademarks.

This document is written in English but may be translated into multiple languages for reference. Only the English version of this document is the final and determinative format released by Diodes Incorporated.

**LIFE SUPPORT**

Diodes Incorporated products are specifically not authorized for use as critical components in life support devices or systems without the express written approval of the Chief Executive Officer of Diodes Incorporated. As used herein:

A. Life support devices or systems are devices or systems which:

1. are intended to implant into the body, or
2. support or sustain life and whose failure to perform when properly used in accordance with instructions for use provided in the labeling can be reasonably expected to result in significant injury to the user.

B. A critical component is any component in a life support device or system whose failure to perform can be reasonably expected to cause the failure of the life support device or to affect its safety or effectiveness.

Customers represent that they have all necessary expertise in the safety and regulatory ramifications of their life support devices or systems, and acknowledge and agree that they are solely responsible for all legal, regulatory and safety-related requirements concerning their products and any use of Diodes Incorporated products in such safety-critical, life support devices or systems, notwithstanding any devices- or systems-related information or support that may be provided by Diodes Incorporated. Further, Customers must fully indemnify Diodes Incorporated and its representatives against any damages arising out of the use of Diodes Incorporated products in such safety-critical, life support devices or systems.

Copyright © 2016, Diodes Incorporated

[www.diodes.com](http://www.diodes.com)



# Mouser Electronics

Authorized Distributor

Click to View Pricing, Inventory, Delivery & Lifecycle Information:

[Diodes Incorporated:](#)

[DDTC123JLP-7](#) [DDTC114YLP-7](#) [DDTC143ZLP-7](#)