

N-Channel 100-V (D-S) 175 °C MOSFET

PRODUCT SUMMARY		
V _{DS} (V)	R _{DS(on)} (Ω)	I _D (A)
100	0.0105 at V _{GS} = 10 V	85 ^a
	0.012 at V _{GS} = 4.5 V	

FEATURES

- TrenchFET[®] Power MOSFET
- 175 °C Maximum Junction Temperature
- Compliant to RoHS Directive 2002/95/EC

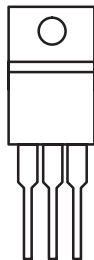

**RoHS
COMPLIANT**
TO-220AB

 G D S
Top View

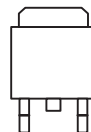
SUP85N10-10

DRAIN connected to TAB

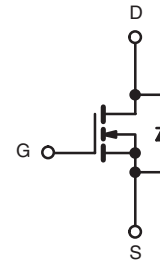
TO-263

 G D S
Top View

SUB85N10-10



N-Channel MOSFET

ORDERING INFORMATION

Package	Lead (Pb)-free
TO-220AB	SUP85N10-10-E3
TO-263	SUB85N10-10-E3

ABSOLUTE MAXIMUM RATINGS T_A = 25 °C, unless otherwise noted

Parameter	Symbol	Limit	Unit
Drain-Source Voltage	V _{DS}	100	V
Gate-Source Voltage	V _{GS}	± 20	
Continuous Drain Current (T _J = 150 °C)	I _D	T _C = 25 °C	85 ^a
		T _C = 125 °C	60 ^a
Pulsed Drain Current	I _{DM}	240	A
Avalanche Current	I _{AS}	75	
Single Pulse Avalanche Energy ^b	E _{AS}	280	mJ
Maximum Power Dissipation ^b	P _D	T _C = 25 °C (TO-220AB and TO-263)	250 ^c
		T _A = 25 °C (TO-263) ^d	3.75
Operating Junction and Storage Temperature Range	T _J , T _{stg}	- 55 to 175	°C

THERMAL RESISTANCE RATINGS

Parameter	Symbol	Limit	Unit
Junction-to-Ambient	R _{thJA}	PCB Mount (TO-263) ^d	40
		Free Air (TO-220AB)	62.5
Junction-to-Case	R _{thJC}	0.6	°C/W

Notes:

- Package limited.
- Duty cycle ≤ 1 %.
- See SOA curve for voltage derating.
- When mounted on 1" square PCB (FR-4 material).

SPECIFICATIONS $T_J = 25\text{ }^\circ\text{C}$, unless otherwise noted						
Parameter	Symbol	Test Conditions	Min.	Typ.	Max.	Unit
Static						
Drain-Source Breakdown Voltage	V_{DS}	$V_{GS} = 0\text{ V}, I_D = 250\text{ }\mu\text{A}$	100			V
Gate-Threshold Voltage	$V_{GS(th)}$	$V_{DS} = V_{GS}, I_D = 250\text{ }\mu\text{A}$	1		3	
Gate-Body Leakage	I_{GSS}	$V_{DS} = 0\text{ V}, V_{GS} = \pm 20\text{ V}$			± 100	nA
Zero Gate Voltage Drain Current	I_{DSS}	$V_{DS} = 100\text{ V}, V_{GS} = 0\text{ V}$			1	μA
		$V_{DS} = 100\text{ V}, V_{GS} = 0\text{ V}, T_J = 125\text{ }^\circ\text{C}$			50	
		$V_{DS} = 100\text{ V}, V_{GS} = 0\text{ V}, T_J = 175\text{ }^\circ\text{C}$			250	
On-State Drain Current ^a	$I_{D(on)}$	$V_{DS} \geq 5\text{ V}, V_{GS} = 10\text{ V}$	120			A
Drain-Source On-State Resistance ^a	$R_{DS(on)}$	$V_{GS} = 10\text{ V}, I_D = 30\text{ A}$		0.0085	0.0105	Ω
		$V_{GS} = 4.5\text{ V}, I_D = 20\text{ A}$		0.010	0.012	
		$V_{GS} = 10\text{ V}, I_D = 30\text{ A}, T_J = 125\text{ }^\circ\text{C}$			0.017	
		$V_{GS} = 10\text{ V}, I_D = 30\text{ A}, T_J = 175\text{ }^\circ\text{C}$			0.022	
Forward Transconductance ^a	g_{fs}	$V_{DS} = 15\text{ V}, I_D = 30\text{ A}$	25			S
Dynamic^b						
Input Capacitance	C_{iss}	$V_{GS} = 0\text{ V}, V_{DS} = 25\text{ V}, f = 1\text{ MHz}$		6550		pF
Output Capacitance	C_{oss}			665		
Reverse Transfer Capacitance	C_{rss}			265		
Total Gate Charge ^c	Q_g	$V_{DS} = 50\text{ V}, V_{GS} = 10\text{ V}, I_D = 85\text{ A}$		105	160	nC
Gate-Source Charge ^c	Q_{gs}			17		
Gate-Drain Charge ^c	Q_{gd}			23		
Turn-On Delay Time ^c	$t_{d(on)}$	$V_{DD} = 50\text{ V}, R_L = 0.6\text{ }\Omega$ $I_D \cong 85\text{ A}, V_{GEN} = 10\text{ V}, R_g = 2.5\text{ }\Omega$		12	25	ns
Rise Time ^c	t_r			90	135	
Turn-Off Delay Time ^c	$t_{d(off)}$			55	85	
Fall Time ^c	t_f			130	195	
Source-Drain Diode Ratings and Characteristics $T_C = 25\text{ }^\circ\text{C}$ ^b						
Continuous Current	I_S				85	A
Pulsed Current	I_{SM}				240	
Forward Voltage ^a	V_{SD}	$I_F = 85\text{ A}, V_{GS} = 0\text{ V}$		1.0	1.5	V
Reverse Recovery Time	t_{rr}	$I_F = 50\text{ A}, di/dt = 100\text{ A}/\mu\text{s}$		85	140	ns
Peak Reverse Recovery Current	$I_{RM(REC)}$			4.5	7	A
Reverse Recovery Charge	Q_{rr}			0.17	0.35	μC

Notes:

- a. Pulse test; pulse width $\leq 300\text{ }\mu\text{s}$, duty cycle $\leq 2\%$.
- b. Guaranteed by design, not subject to production testing.
- c. Independent of operating temperature.

Stresses beyond those listed under "Absolute Maximum Ratings" may cause permanent damage to the device. These are stress ratings only, and functional operation of the device at these or any other conditions beyond those indicated in the operational sections of the specifications is not implied. Exposure to absolute maximum rating conditions for extended periods may affect device reliability.

TYPICAL CHARACTERISTICS $T_A = 25\text{ }^\circ\text{C}$, unless otherwise noted

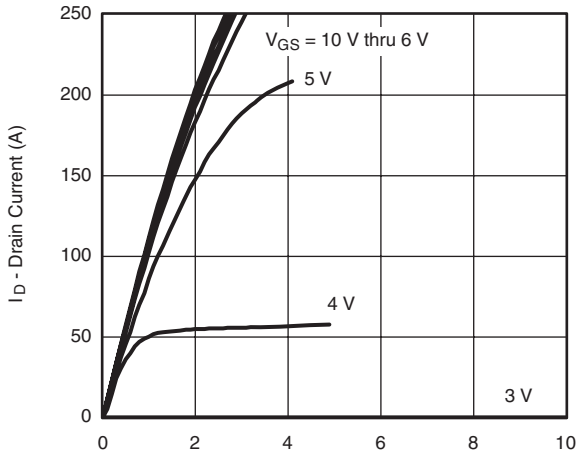

$V_{GS} = 10\text{ V thru } 6\text{ V}$
Output Characteristics

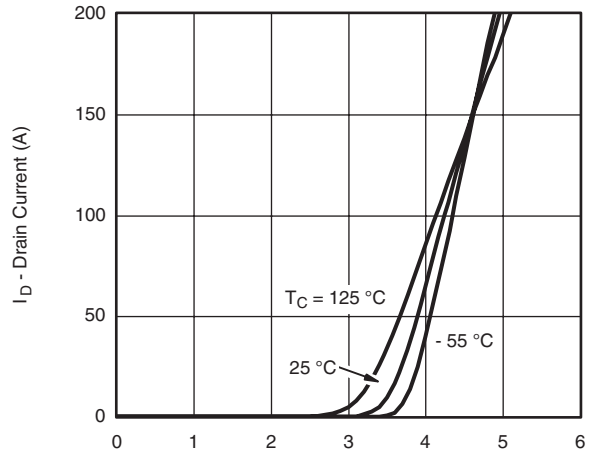

$T_C = 125\text{ }^\circ\text{C}$
 $25\text{ }^\circ\text{C}$
 $-55\text{ }^\circ\text{C}$
Transfer Characteristics

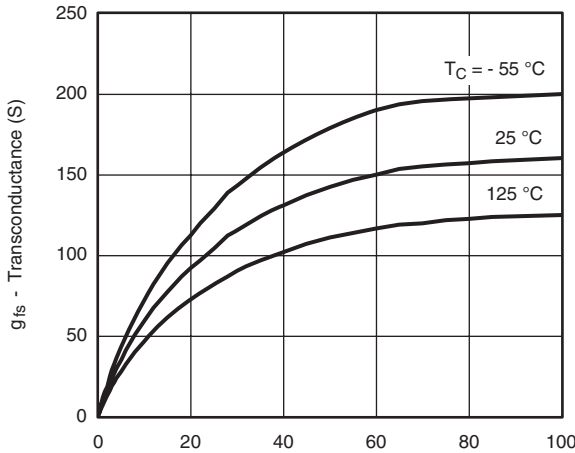

$T_C = -55\text{ }^\circ\text{C}$
 $25\text{ }^\circ\text{C}$
 $125\text{ }^\circ\text{C}$
Transconductance

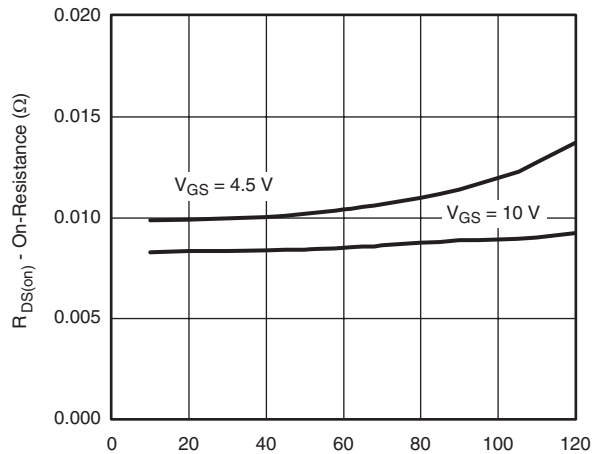

$V_{GS} = 4.5\text{ V}$
 $V_{GS} = 10\text{ V}$
On-Resistance vs. Drain Current

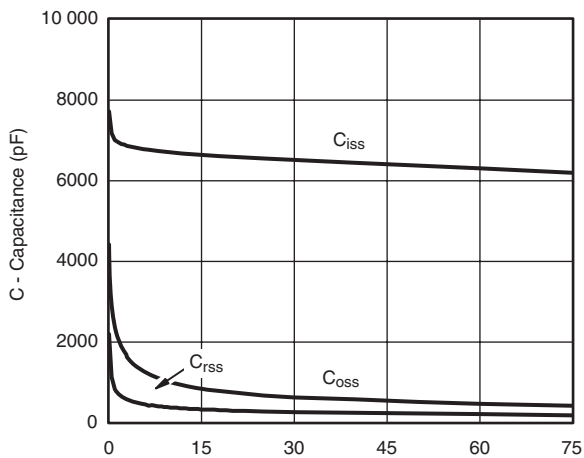

C_{iss}
 C_{rss}
 C_{oss}
Capacitance

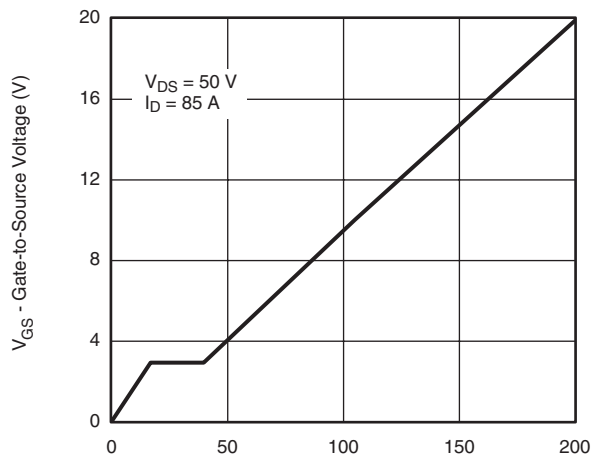

$V_{DS} = 50\text{ V}$
 $I_D = 85\text{ A}$
Gate Charge

TYPICAL CHARACTERISTICS $T_A = 25\text{ }^\circ\text{C}$, unless otherwise noted

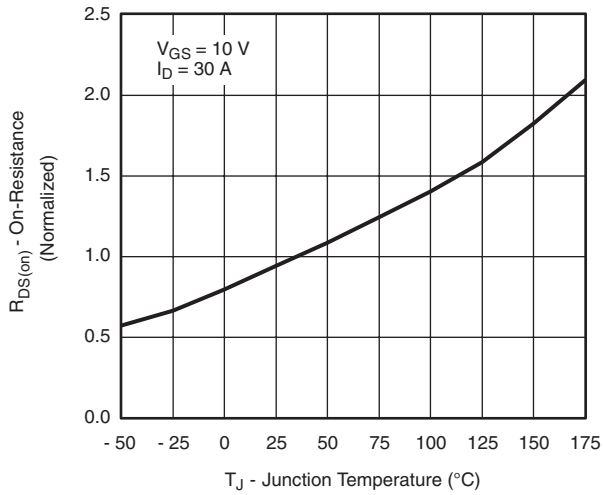

On-Resistance vs. Junction Temperature

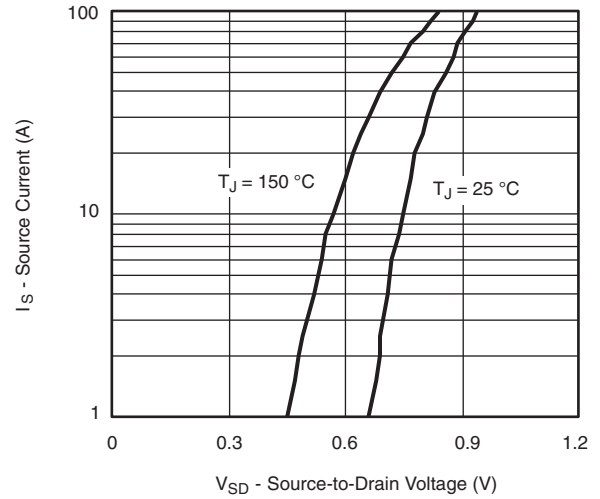

Source-Drain Diode Forward Voltage

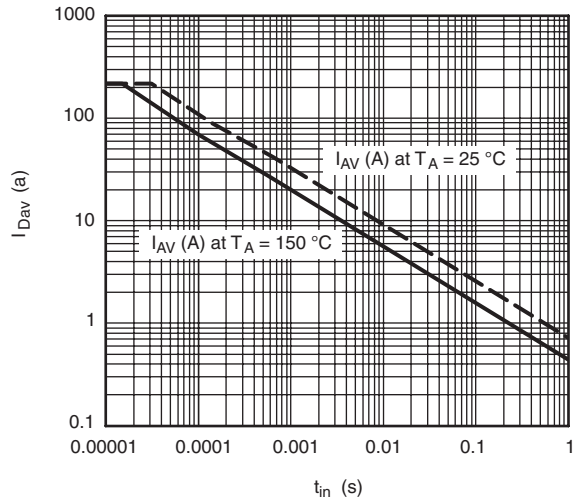

Avalanche Current vs. Time

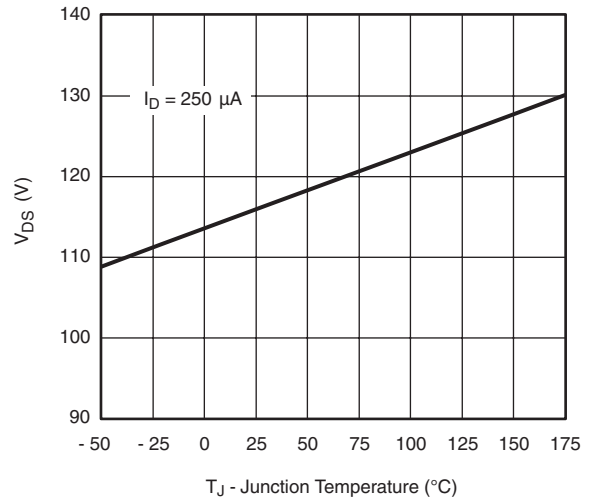

T_J - Drain-Source Breakdown vs. Junction-Temperature

THERMAL RATINGS

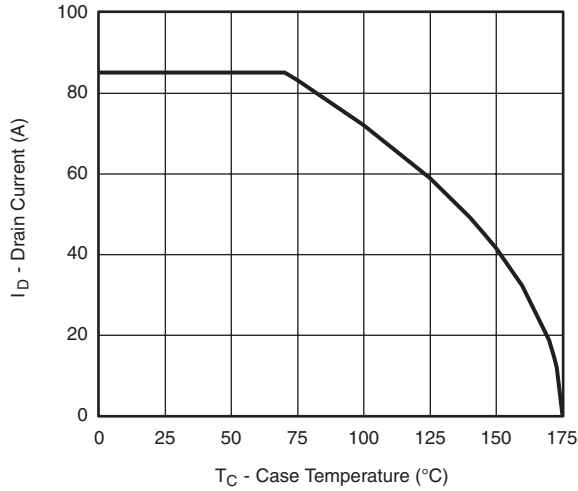

Maximum Avalanche and Drain Current vs. Case Temperature

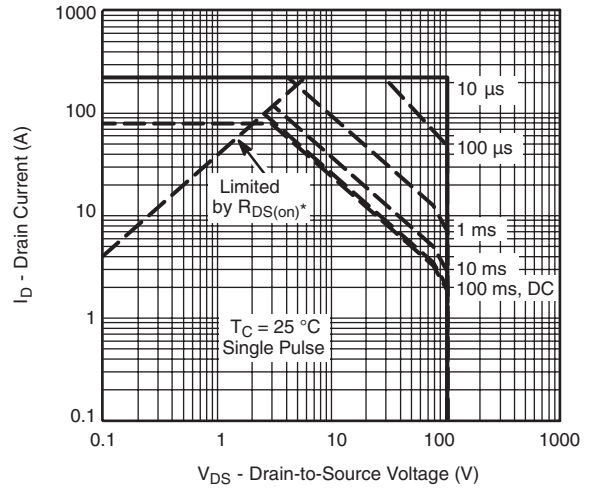

Safe Operating Area
* $V_{GS} >$ minimum V_{GS} at which $R_{DS(on)}$ is specified

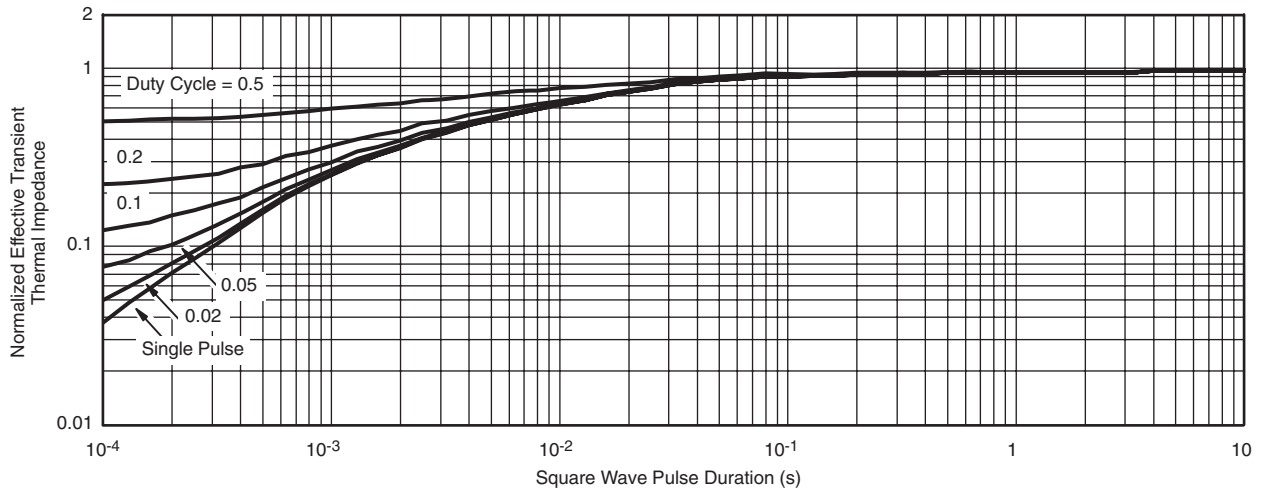

Normalized Thermal Transient Impedance, Junction-to-Case

Vishay Siliconix maintains worldwide manufacturing capability. Products may be manufactured at one of several qualified locations. Reliability data for Silicon Technology and Package Reliability represent a composite of all qualified locations. For related documents such as package/tape drawings, part marking, and reliability data, see www.vishay.com/ppg?71141.



TO-220AB

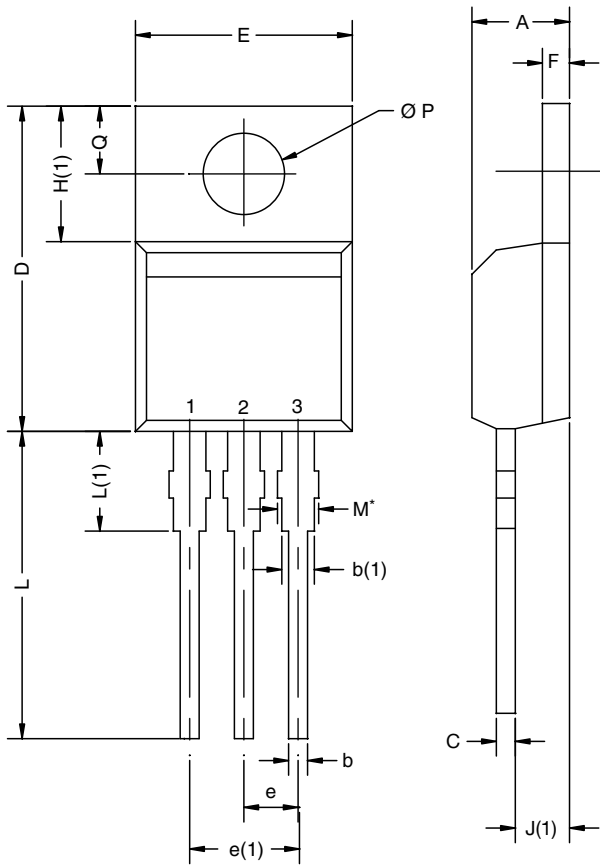

DIM.	MILLIMETERS		INCHES	
	MIN.	MAX.	MIN.	MAX.
A	4.25	4.65	0.167	0.183
b	0.69	1.01	0.027	0.040
b(1)	1.20	1.73	0.047	0.068
c	0.36	0.61	0.014	0.024
D	14.85	15.49	0.585	0.610
D2	12.19	12.70	0.480	0.500
E	10.04	10.51	0.395	0.414
e	2.41	2.67	0.095	0.105
e(1)	4.88	5.28	0.192	0.208
F	1.14	1.40	0.045	0.055
H(1)	6.09	6.48	0.240	0.255
J(1)	2.41	2.92	0.095	0.115
L	13.35	14.02	0.526	0.552
L(1)	3.32	3.82	0.131	0.150
$\varnothing P$	3.54	3.94	0.139	0.155
Q	2.60	3.00	0.102	0.118

ECN: T14-0413-Rev. P, 16-Jun-14
DWG: 5471

Note

* M = 1.32 mm to 1.62 mm (dimension including protrusion)
Heatsink hole for HVM

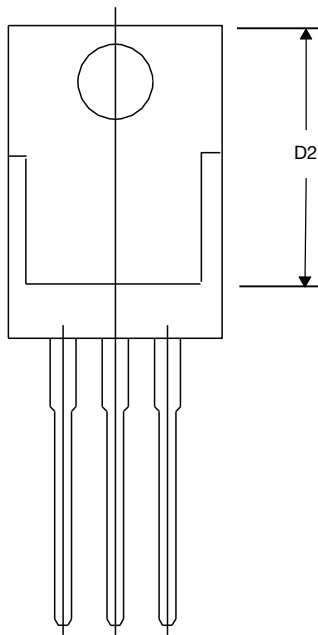



Disclaimer

ALL PRODUCT, PRODUCT SPECIFICATIONS AND DATA ARE SUBJECT TO CHANGE WITHOUT NOTICE TO IMPROVE RELIABILITY, FUNCTION OR DESIGN OR OTHERWISE.

Vishay Intertechnology, Inc., its affiliates, agents, and employees, and all persons acting on its or their behalf (collectively, "Vishay"), disclaim any and all liability for any errors, inaccuracies or incompleteness contained in any datasheet or in any other disclosure relating to any product.

Vishay makes no warranty, representation or guarantee regarding the suitability of the products for any particular purpose or the continuing production of any product. To the maximum extent permitted by applicable law, Vishay disclaims (i) any and all liability arising out of the application or use of any product, (ii) any and all liability, including without limitation special, consequential or incidental damages, and (iii) any and all implied warranties, including warranties of fitness for particular purpose, non-infringement and merchantability.

Statements regarding the suitability of products for certain types of applications are based on Vishay's knowledge of typical requirements that are often placed on Vishay products in generic applications. Such statements are not binding statements about the suitability of products for a particular application. It is the customer's responsibility to validate that a particular product with the properties described in the product specification is suitable for use in a particular application. Parameters provided in datasheets and / or specifications may vary in different applications and performance may vary over time. All operating parameters, including typical parameters, must be validated for each customer application by the customer's technical experts. Product specifications do not expand or otherwise modify Vishay's terms and conditions of purchase, including but not limited to the warranty expressed therein.

Except as expressly indicated in writing, Vishay products are not designed for use in medical, life-saving, or life-sustaining applications or for any other application in which the failure of the Vishay product could result in personal injury or death. Customers using or selling Vishay products not expressly indicated for use in such applications do so at their own risk. Please contact authorized Vishay personnel to obtain written terms and conditions regarding products designed for such applications.

No license, express or implied, by estoppel or otherwise, to any intellectual property rights is granted by this document or by any conduct of Vishay. Product names and markings noted herein may be trademarks of their respective owners.

Mouser Electronics

Authorized Distributor

Click to View Pricing, Inventory, Delivery & Lifecycle Information:

[Vishay:](#)

[SUB85N10-10-E3](#) [SUB85N10-10](#) [SUP85N10-10-GE3](#) [SUP85N10-10P-GE3](#)