

**SERIES:** SJ-356XN | **DESCRIPTION:** 3.5 MM AUDIO JACKS

**FEATURES**

- low profile design
- switch options include:
  - no switch
  - tip switch
  - ring switch
  - tip and ring switch

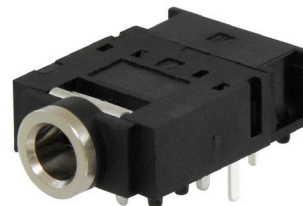

**PART NUMBER KEY**

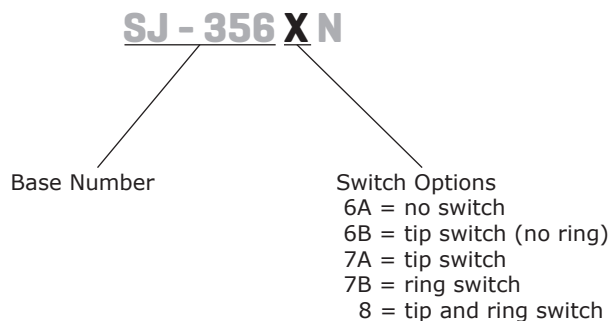

**SPECIFICATIONS**

parameter	conditions/description	min	typ	max	units
rated input voltage			12		Vdc
rated input current				1	A
contact resistance	between terminal and mating plug between terminal in a closed circuit <sup>1</sup>			50 30	mΩ mΩ
insulation resistance	at 500 Vdc	100			MΩ
voltage withstand	at 50/60Hz for 1 minute			500	Vac
insertion/withdrawal force		0.3		3	kg
terminal strength	any direction for 10 seconds			500	g
operating temperature		-40		85	°C
life			5,000		cycles
flammability rating	UL94V-0				
RoHS	2011/65/EU				

Note: 1. When measured at a current of less than 100 mA / 1 kHz

**SOLDERABILITY**

parameter	conditions/description	min	typ	max	units
wave soldering	dipped in solder pot for 5±0.5 seconds at	255	260	265	°C

## MECHANICAL DRAWING

units: mm [inches]  
 tolerance: X.X=±0.5 mm  
 X.XX=±0.1 mm  
 X.XXX=±0.05 mm

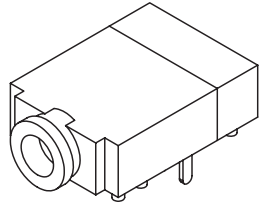

	MATERIAL	PLATING
terminal 1	copper alloy	silver
terminal 2	stainless steel	silver
terminal 3	copper alloy	silver
terminal 4	brass	silver
terminal 5	brass	silver
terminal 6	brass	silver
terminal 10	brass	silver
terminal 11	brass	silver
bushing	brass	nickel
plastic	PA66	
contact clip	C5210	silver

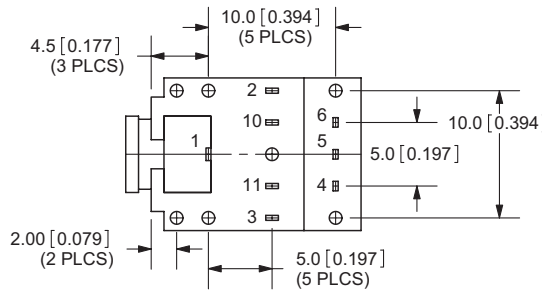
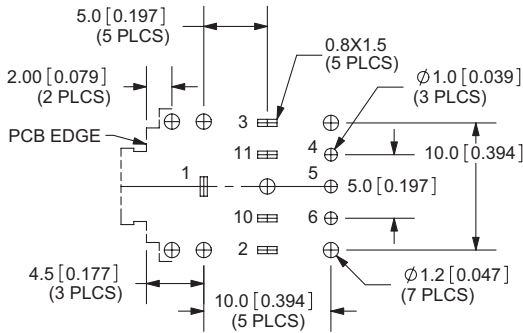
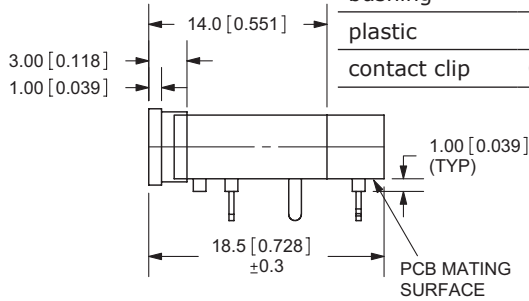
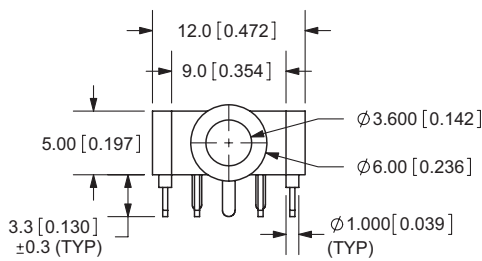

PCB LAYOUT TOP VIEW

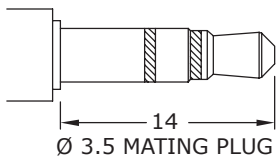

Model No.	SJ-3566AN	SJ-3566BN	SJ-3567AN	SJ-3567BN	SJ-3568N
Schematic					
PIN					
1	sleeve	sleeve	sleeve	sleeve	sleeve
2	tip	tip	tip	tip	tip
3	ring	NP	ring	ring	ring
10	NP	tip switch	tip switch	NP	tip switch
11	NP	NP	NP	ring switch	ring switch

Note: 1. All specifications measured at 10~35°C, humidity at 45~85%, under standard atmospheric pressure, unless otherwise noted.

## REVISION HISTORY

rev.	description	date
1.0	initial release	09/13/2006
1.01	new template applied	12/13/2011
1.02	widened operating temperature range	09/25/2013
1.03	updated drawing	02/20/2015
1.04	changed material of terminal 2 to be stainless steel	04/05/2016
1.05	changed terminal plating to silver	02/13/2019

The revision history provided is for informational purposes only and is believed to be accurate.



**Headquarters**  
20050 SW 112th Ave.  
Tualatin, OR 97062  
**800.275.4899**

Fax 503.612.2383  
**cui.com**  
techsupport@cui.com

CUI offers a one (1) year limited warranty. Complete warranty information is listed on our website.

CUI reserves the right to make changes to the product at any time without notice. Information provided by CUI is believed to be accurate and reliable. However, no responsibility is assumed by CUI for its use, nor for any infringements of patents or other rights of third parties which may result from its use.

CUI products are not authorized or warranted for use as critical components in equipment that requires an extremely high level of reliability. A critical component is any component of a life support device or system whose failure to perform can be reasonably expected to cause the failure of the life support device or system, or to affect its safety or effectiveness.