



## 17.5 mm DIN rail mounting MUS2 Part number 88827004



- Relay or solid state output
- Multi-function or mono-function
- Multi-range
- Multi-voltage
- Screw or spring terminals
- LED status indicator (relay version)
- Option of connecting an external power supply to the control input
- 3-wire sensor control option

### Part numbers

	Type	Functions	Timing	Output	Nominal rating	Connections	Supply voltage
88 827 004	MUS2	A - Ac - At - B - Bw - C - D - Di - H - Ht	0,1s→100h	Solid state	0,7 A	Screw terminals	24 →240 V AC

### Specifications

#### Timing

Timing ranges (7 ranges)	1 s - 10 s - 1 min - 10 min - 1 h - 10 h - 100 h
Repetition accuracy with constant parameters	± 0.5 % (IEC/EN 61812-1)
Drift Temperature	± 0,05 % / °C
Drift Voltage	± 0,2 % / V
Display accuracy according to IEC/EN 61812-1	± 10 % / 25 °C
Minimum pulse duration typically (relay version)	30 ms
Minimum pulse duration typically (solid state version)	50 ms
Minimum pulse duration typically (relay version under load)	100 ms
Maximum reset time by de-energisation typically (relay version)	120 ms
Maximum reset time by de-energisation typically (solid state version)	350 ms
Immunity from micro power cuts : typical	< 10 ms

#### Supply

Multi-voltage power supply	Depending on version
Frequency (Hz)	50 / 60
Operating range	85 →110 % Un 85 →120 % Un for 12 V AC / DC
Operator factor	100 %
Max. absorbed power	32 VA (240 VAC) 1,5 W (240 VDC) 0,6 W (24 VDC) 0,7 VA (12 VAC) 0,7 W (12 VDC)

#### Output specification

1 or 2 changeover relays, AgNi (cadmium-free)	1 C/O
Rated power	2000 VA/80 W
Maximum breaking current	8 AAC 250 VAC resistive 8 ADC 30 VDC resistive
Minimum breaking current	10 mA / 5 VDC
Voltage breaking capacity	250 VAC / 8 AAC resistive 250 VDC / 0,3 A resistive
Electrical life (operations)	10 <sup>5</sup> 8 A 250 VAC resistive
Mechanical life (operations)	10 x 10 <sup>6</sup>
Breakdown voltage acc. to IEC/EN 61812-1	2,5 kV / 1 min / 1 mA / 50 Hz
Impulse voltage acc. to IEC/EN 60664-1, IEC/EN 61812-1	5 kV wave 1.2 / 50 µs

#### Solid state output

Rated power	0,7 A AC / DC 20 °C (0,5 A UL)
Derating	5 mA/ °C
Maximum admissible current	20 A ≤ 10 ms
Minimum breaking current	10 mA
Leakage current	< 5 mA
Voltage breaking capacity	250 VAC / DC

Maximum voltage drop at terminals	3 wire 4V 2 wire 8V
Electrical life (operations)	10 <sup>8</sup>
Breakdown voltage acc. to IEC/EN 60664-1, IEC/EN 60255-5	2.5 kV to 1 mA / 1 min
Input type	Volt-free contact 3-wire PNP output control option residual voltage : 0.4V whatever the timer power supply

### General characteristics

Conformity to standards	IEC/EN 61812-1 IEC/EN 61000-6-1 IEC/EN 61000-6-2 IEC/EN 61000-6-3 IEC/EN 61000-6-4
Certifications	CE, UL, cUL, CSA, GL
Temperature limits use (°C)	-20 → +60
Temperature limits stored (°C)	-30 → +60
Installation category (acc. to IEC/EN 60664-1)	Voltage surge category III
Creepage distance and clearance acc. to IEC/EN 60664-1	4 kV / 3 mm
Protection (IEC/EN 60529)	IP20 IP40
Degree of protection acc. to IEC/EN 60529 Front face	IP50
Vibration resistance acc. to IEC/EN 60068-2-6	20 m/s <sup>2</sup> 10 Hz → 150 Hz
Relative humidity no condensation acc. to IEC/EN 60068-2-30	93 % non-condensing
Electromagnetic compatibility - Immunity to electrostatic discharges acc to IEC/EN 61000-4-2	Level III (Air 8 kV / Contact 6 kV)
Immunity to radiated, radio-frequency, electromagnetic field acc. IEC/EN 61000-4-3	Level I (1 V/m : 2,0 G Hz → 2,7 G Hz) Level II (3 V/m : 1,4 G Hz → 2,0 G Hz) Level III (10 V/m : 80 M Hz → 1 G Hz)
Immunity to rapid transient bursts acc. to IEC/EN 61000-4-4	Level III (direct 2 kV / Capacitive coupling clamp 1 kV)
Immunity to shock waves on power supply acc. to IEC/EN 61000-4-5	Level III (2 kV / common mode 2 kV/residual current mode 1 kV)
Immunity to radio frequency in common mode acc. to IEC/EN 61000-4-6	Level III (10V rms : 0.15 M Hz to 80 M Hz)
Immunity to voltage dips and breaks acc. to IEC/EN 61000-4-11	0 % residual voltage, 1 cycle 70 % residual voltage, 25/30 cycles
Mains-borne and radiated emissions acc. to EN 55022 (CISPR22), EN55011 (CISPR11)	Class B
Fixing : Symmetrical DIN rail	35 mm
Terminal capacity Single-wire without ferrule	1 x 0,5 → 3,3 mm <sup>2</sup> (AWG 20 → AWG 12) 2 x 0,5 → 2,5 mm <sup>2</sup> (AWG 20 → AWG 14)
Terminal capacity Multi-wire with ferrule	1 x 0,5 → 2,5 mm <sup>2</sup> (AWG 20 → AWG 14) 2 x 0,5 → 1,5 mm <sup>2</sup> (AWG 20 → AWG 16)
Spring terminals, 2 terminals per connection point - flexible wire	2 x 0,5 → 1,5 mm <sup>2</sup> (AWG 20 → AWG 16)
Spring terminals, 2 terminals per connection point - rigid wire	2 x 0,5 → 1,5 mm <sup>2</sup> (AWG 20 → AWG 16)
Housing material	Self-extinguishing
Weight : casing 17,5 mm	88827105 (MUR1) : 63 g 88827115 (MAR1) : 63 g 88827125 (MBR1) : 63 g 88827135 (MCR1) : 62 g 88827145 (MHR1) : 63 g 88827150 (MLR4) : 63 g 88827155 (MLR1) : 64 g 88827100 (MUR4) : 62 g 88827103 (MUR3) : 66 g 88827503 (MURc3) : 59 g 88827150 (MLR4) : 63 g 88827185 (MXR1) : 63 g 88827004 (MUS2) : 55 g 88827014 (MAS5) : 53 g 88827044 (MHS2) : 53 g 88827054 (MLS2) : 56 g
Shock test IEC/EN 60068-2-27	15 g - 11 ms
Short interruption on power line acc to IEC/EN 61000-4-11	0 % residual voltage, 250/300 cycles
Insulation resistance according to IEC/EN 60664-1	100 MΩ (500 VDC)

### Dimensions (mm)

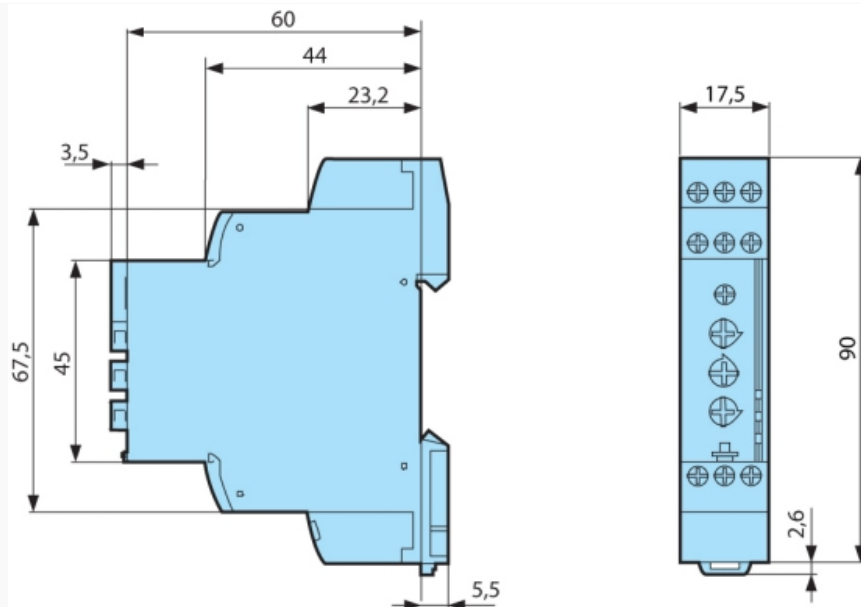

**Curves**

**Function A**

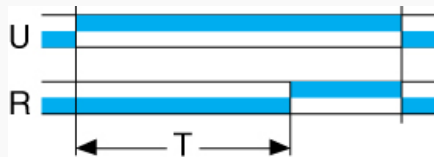

**Function A**

Delay on energisation 1 relay

**Curves**

**Function Ac**



**Function Ac**

Timing after closing and opening of control contact 1 relay

**Curves**

**Function At**

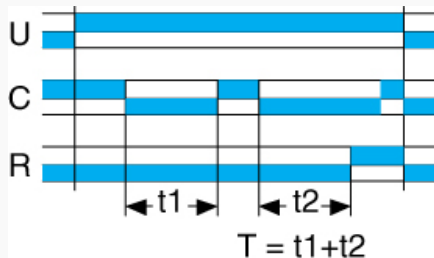

**Function At**

Timing on energisation with memory 1 relay

Curves

Function B

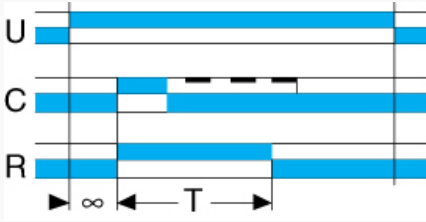

Function B

Timing on impulse one shot 1 relay

Curves

Function Bw

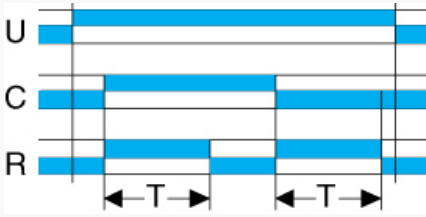

Function Bw

Pulse output (adjustable) 1 relay

Curves

Function C

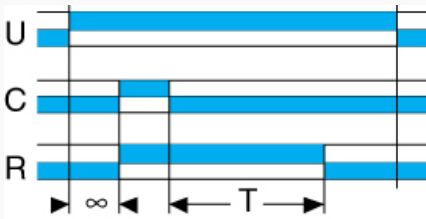

Function C

Timing after impulse 1 relay

Curves

Function D

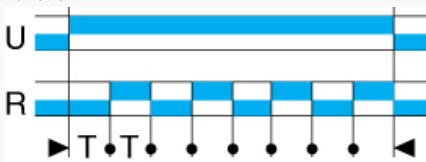

Function D

Flip-flop Pause start 1 relay

Curves

Function Di

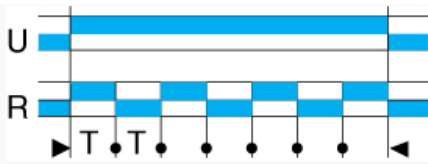

**Function Di**  
 Flip-flop Pulse start 1 relay

**Curves**

**Function H**



**Function H**  
 Timing on energisation 1 relay

**Curves**

**Function Ht**

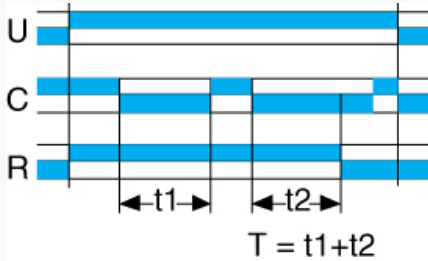

**Function Ht**  
 Delay on energisation with memory 1 relay

**Connections**

**Solid state output**

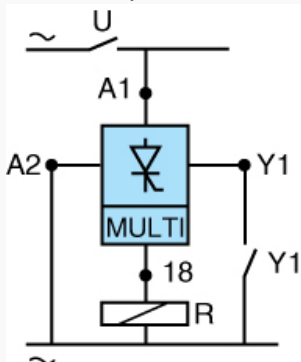

# Mouser Electronics

Authorized Distributor

Click to View Pricing, Inventory, Delivery & Lifecycle Information:

[Crouzet:](#)

[88827004](#)