

## BARBARA-WW

~60° wide beam

### TECHNICAL SPECIFICATIONS:

Dimensions	Ø 70.0 mm
Height	44.7 mm
Fastening	glue
ROHS compliant	yes ⓘ

### MATERIAL SPECIFICATIONS:

Component	Type	Material
BARBARA-WW	Reflector	PC



Colour	Finish	Coating
metal		lacquer

### ORDERING INFORMATION:

#### Component



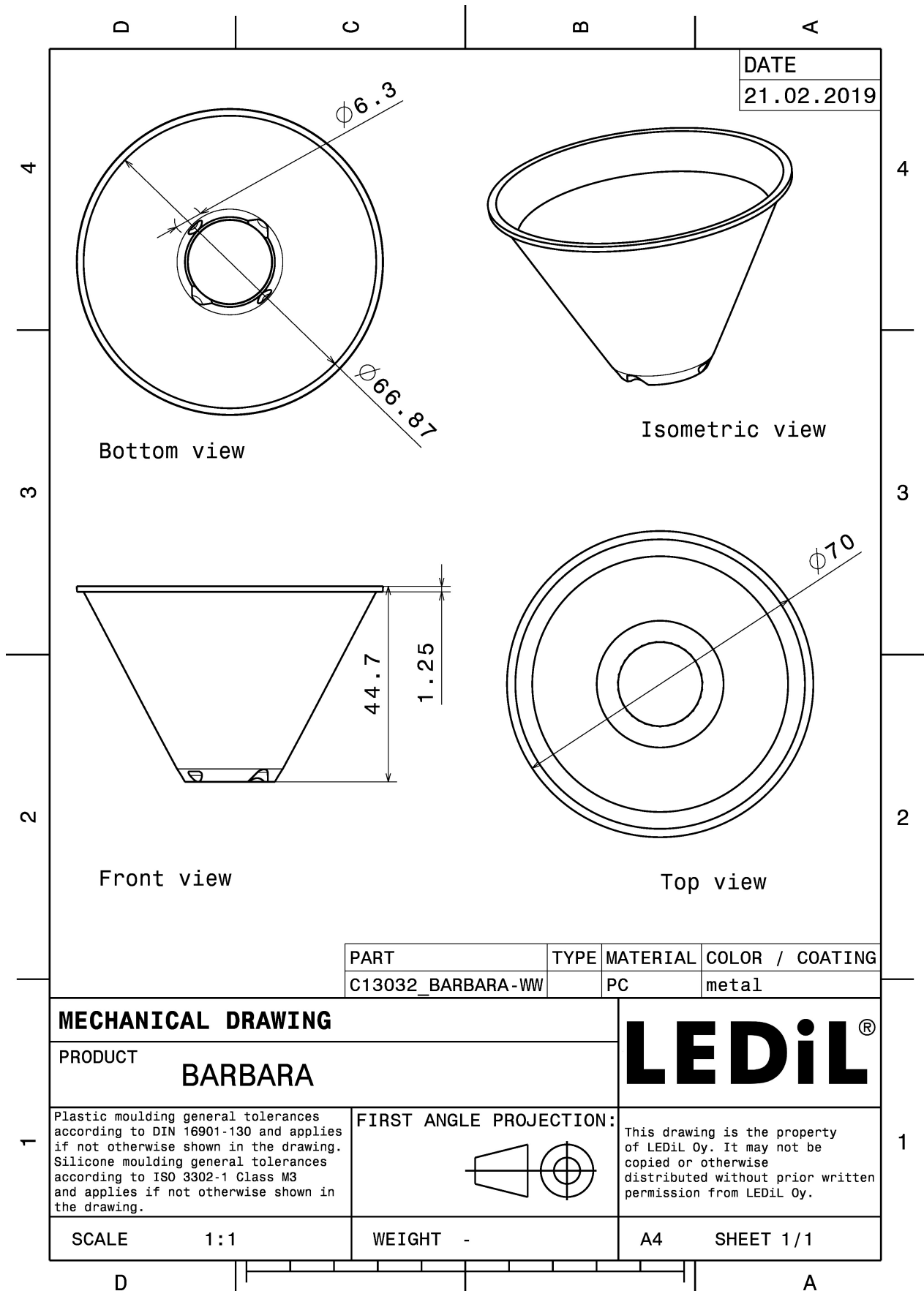

C13032\_BARBARA-WW

» Box size: 476 x 273 x 247 mm

Qty in box	MOQ	MPQ	Box weight (kg)
288	90	18	5.7

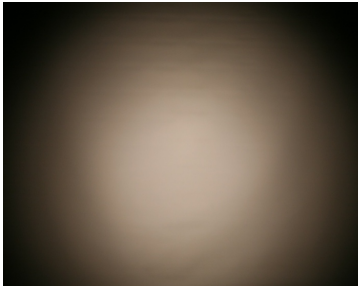
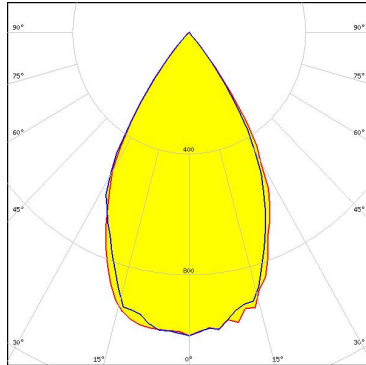

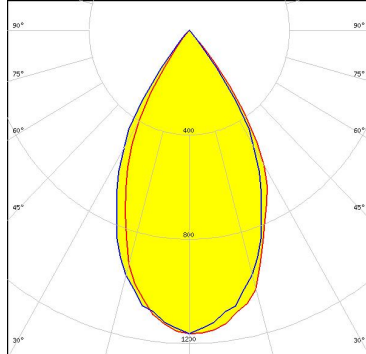
#### PHOTOMETRIC DATA (MEASURED):

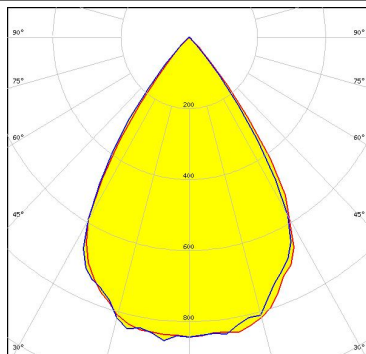
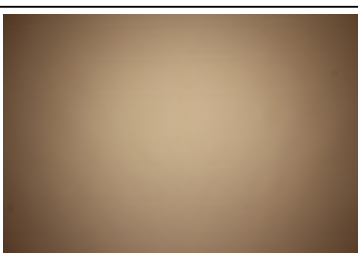
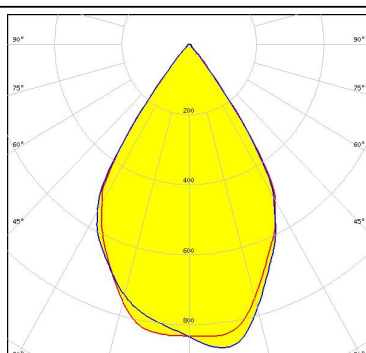
<p>bridgelux.</p> <p>LED BXRA ES Rectangle</p> <p>FWHM 60.0°</p> <p>Efficiency 89 %</p> <p>Peak intensity 1 cd/lm</p> <p>LEDs/each optic 1</p> <p>Light colour White</p> <p>Required components:</p>		
<p><b>CITIZEN</b></p> <p>LED CL-L330</p> <p>FWHM 55.0°</p> <p>Efficiency 88 %</p> <p>Peak intensity 1.2 cd/lm</p> <p>LEDs/each optic 1</p> <p>Light colour White</p> <p>Required components:</p>		
<p><b>CITIZEN</b></p> <p>LED CLL03x/CLU03x</p> <p>FWHM 70.0°</p> <p>Efficiency 88 %</p> <p>Peak intensity 0.8 cd/lm</p> <p>LEDs/each optic 1</p> <p>Light colour White</p> <p>Required components:</p>		
<p><b>CITIZEN</b></p> <p>LED CLU720/721</p> <p>FWHM 66.0°</p> <p>Efficiency 81 %</p> <p>Peak intensity 0.9 cd/lm</p> <p>LEDs/each optic 1</p> <p>Light colour White</p> <p>Required components:</p>		

### PHOTOMETRIC DATA (MEASURED):



LED CXA2011  
FWHM 60.0°  
Efficiency 90 %  
Peak intensity 1 cd/lm  
LEDs/each optic 1  
Light colour White  
Required components:

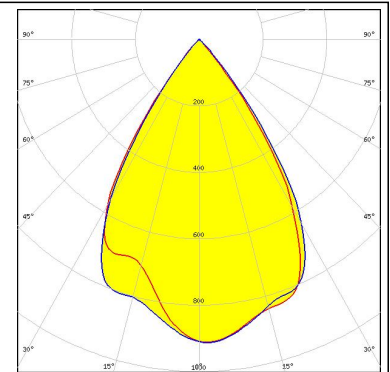
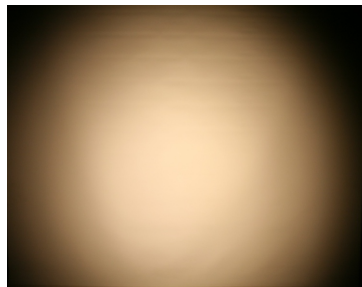

LED COB 10W/13W/17W/24W  
FWHM 65.0°  
Efficiency %  
Peak intensity 0.9 cd/lm  
LEDs/each optic 1  
Light colour White  
Required components:

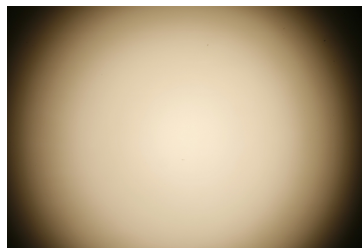

LED CxM-14 (19x19)  
FWHM 68.0°  
Efficiency 80 %  
Peak intensity 0.8 cd/lm  
LEDs/each optic 1  
Light colour White  
Required components:

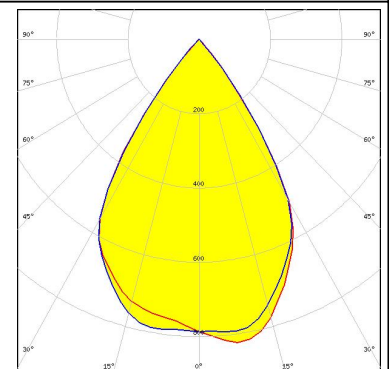
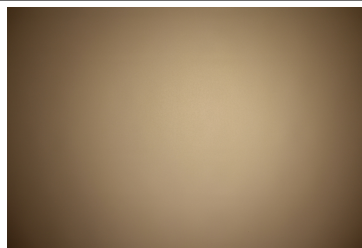

### GENERAL INFORMATION:

NOTE: The typical beam angle will be changed by different color, chip size and chip position tolerance. The typical total beam angle is the full angle measured where the luminous intensity is half of the peak value.

Due to use of high power COB's with this product, special attention to proper thermal design is highly recommended. LEDiL has no liability for direct, indirect or consecutive damages arising from the LEDiL products being used outside of the recommended temperature range.

### MATERIALS:

As part of our continuous research and improvement processes, and to ensure the best possible quality and availability of our products, LEDiL reserves the right to change material grades without notice.

### PRODUCT DATA USER AGREEMENT AND DISCLAIMER:

The measured data in the provided downloadable LEDiL Product Datasheets and Mechanical 2D-Drawings is rounded and provided as reference for planning. LEDiL Oy's optical specifications have been verified by conducting performance testing of the products in accordance with the company's quality system. The reported data are averaged results of multiple measurements with typical variation. LEDiL Oy reserves the right to without prior notification make changes and improvements to its products.

LEDiL Oy assumes neither warranty, nor guarantee nor any other liability of any kind for the contents and correctness of the provided data. The provided data has been generated with highest diligence but the provided data may in reality not represent the complete possible variation range of all intrinsic parameters. Therefore, in certain cases a deviation from the provided data could occur.

LEDiL Oy reserves the right to undertake technical changes of its products without further notification which could lead to changes in the provided data. LEDiL Oy assumes no liability of any kind for the possible deviation from any provided data or any other damage resulting from the usage of the provided data.

The user agrees to this disclaimer and user agreement with the download or usage of the provided files.

#### LEDiL Oy

Joensuunkatu 13  
FI-24240 SALO  
Finland

#### LEDiL Inc.

228 West Page Street  
Suite D  
Sycamore IL 60178  
USA

#### Local sales and technical support

[www.ledil.com/where\\_to\\_buy](http://www.ledil.com/where_to_buy)

#### Shipping locations

Salo, Finland  
Hong Kong, China

#### Distribution Partners

[www.ledil.com/where\\_to\\_buy](http://www.ledil.com/where_to_buy)

# Mouser Electronics

Authorized Distributor

Click to View Pricing, Inventory, Delivery & Lifecycle Information:

Ledil:

[C13032\\_BARBARA-WW](#)