

# AVX

A KYOCERA GROUP COMPANY

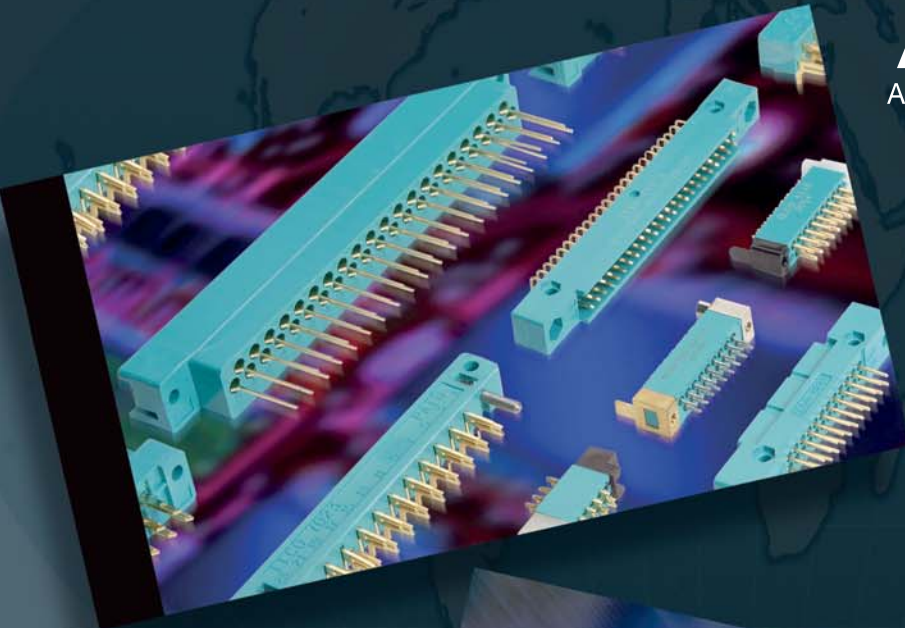

**AVX**  
**Varicon**

<Version 13.10>

---

|                              |   |
|------------------------------|---|
| The Varicon Range.....       | 2 |
| Introduction to Varicon..... | 3 |

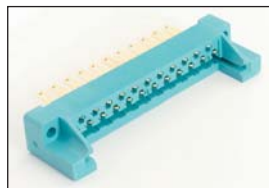

**Series 7008**  
Page 6



**Tools**  
Page 26

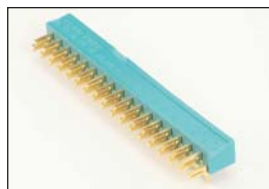

**Series 7022**  
Page 8

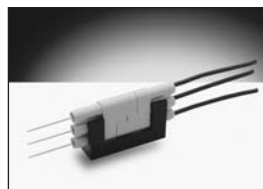

**Series 8020**  
Page 27

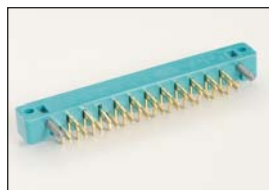

**Series 7023**  
Page 9

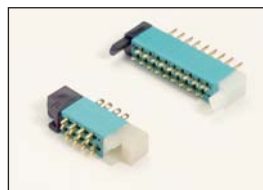

**Series 8218**  
Page 28

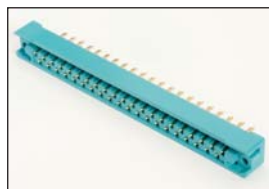

**Series 7024**  
Page 10

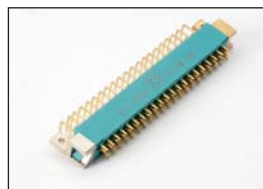

**Series 8219**  
Page 30

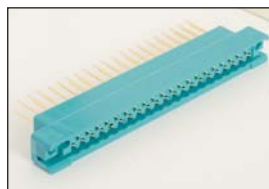

**Series 7038**  
Page 12

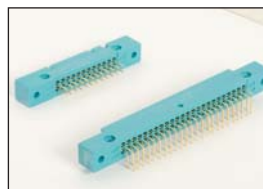

**Series 8223**  
Page 32



**Series 8016**  
Page 14

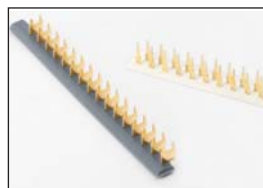

**Contact Strips**  
Page 34



**Series 8017**  
Page 24

# The Varicon Range



| Pitch                                   | Number of Contacts                      | Body Style            | Termination Types  | Current Rating (Amps) | Series Number    |
|---|---|-----------------------|--|-----------------------|------------------|
| 0.050"                                  | 2 to 152                                | Plugs and Receptacles | Staggered, Fixed: Solder, Eyelet   | 5                     | 8218             |
| 0.050"                                  | 18, 30, 36, 42, 54, 72                  | Plugs and Receptacles | Staggered, Fixed: Straight & Right Angle Solder, Eyelet  | 5                     | 8219             |
| 0.075" x 0.130"<br>&<br>0.075" x 0.150" | 20, 38, 56, 90, 120<br><br>75, 100, 130 | Plugs and Receptacles | Staggered, Removable: Taper Tab, Eyelet, Wire Wrap, Crimp  | 8                     | 8016<br><br>8017 |
| 0.100"                                  | 17, 23, 29, 35, 41                      | Receptacles           | Same as series 7024  | 8                     | 7008             |
| 0.100"                                  | 17, 23, 29, 35, 41, 47                  | Plugs                 | Staggered, Fixed: Solder   | 6                     | 7022             |
| 0.100"                                  | 17, 23, 29, 35, 41, 47                  | Receptacles           | Staggered, Fixed: Solder   | 6                     | 7023             |
| 0.100"                                  | 17, 23, 29, 35, 41                      | Receptacles           | Staggered, Fixed: Solder, Taper Tab, Eyelet, Wire Wrap, Bus Line   | 8                     | 7024             |
| 0.100"                                  | 17, 23, 29, 35, 41, 47                  | Receptacles           | Staggered, Removable: Taper Tab, Eyelet, Wire Wrap, Crimp  | 8                     | 7038             |
| 0.100"                                  | 24, 48, 72, 96                          | Plugs and Receptacles | Square Grid Dual Row, Fixed: Straight and Right Angle Solder, Eyelet, Wire Wrap, Crimp Wrappable Removable | 5                     | 8223             |
| 0.200"                                  | 2, 3                                    | Plugs and Receptacles | In-line Fixed: Solder Crimp  | 8.5                   | 8020             |

## Introduction

AVX's Varicon product range is available as two-piece input / output and board level connectors (intermateable plugs and receptacles). Varicon contacts are also available in strips, on disposable carriers, ready for staking to p.c. cards. They all use the famous, fork-like Varicon® (fixed) or Varilok® (insertable / removable) hermaphroditic contact design.

### VARICON DESIGN ADVANTAGES

AVX's hermaphroditic Varicon contact utilizes a fork-like design incorporating four large mating surfaces that are coined to achieve exceptional hardness and smoothness. The mating surfaces are wedged together by the spring-like design of the contact and by the innate properties of the contact material. The Varicon contact has proven its reliability in innumerable applications and with over one-million contacts being produced daily, billions of successful, trouble-free operating hours have been logged.

### FEATURES

- Four intimate contact areas, electrically parallel
- High current carrying capability, excellent heat dissipation
- Self-cleaning, wiping action burnishes contacting surfaces reducing constrictive resistance
- Low contact resistance 3 to 4 milliohms
- Stable in vibration and adverse environments
- High contact normal pressure achieved at low stress levels

### HIGH RELIABILITY

The mating surfaces provide a gas-tight connection and resists corrosion caused by adverse environments. This seal is made possible by the spring-like properties of the Varicon contact and by the smoothness of the coined mating surfaces. After being mated for years, the contacts still retain clean, unoxidized mating surfaces.

### LOW RESISTANCE

Because of the spring-like properties of the Varicon contact, both sides of the contact are always under considerable pressure when mated. Their sliding and wiping action burnishes the surfaces in a self-cleaning action reducing any constrictive resistance. The low contact resistance remains a permanent feature of the Varicon contact even after thousands of mating and unmating cycles.

### HIGH CURRENT CAPACITY

The low contact resistance contributes substantially to Varicon's high current-carrying capacity. Also, its heat-dissipating characteristics are enhanced by its flat configuration.



### SHOCK AND VIBRATION RESISTANCE

Should external forces cause any decrease in contact pressure between two of the four mating surfaces, it is automatically compensated by redistributing the contact pressure between the other two mating surfaces.

### ECONOMY

Varicon contacts are stamped from sheet stock instead of screw-machined. Consequently, this production method not only increases the production capacity but decreases production cost as there is little waste.

### VERSATILITY

The Varicon concept can be used in a card-mounted plug that mates with a receptacle, or Varicon contacts can be staked directly to a pc board and soldered into place. This latter method eliminates the need for a conventional plug reducing the cost of the connection system while retaining the proven reliability of the Varicon interconnection.

### CONTACT TYPES

Two basic sizes of our Varicon contact are available: standard and miniature Varicon. And each size has two major variations: the fixed Varicon contact and the Varilok insertable / removable version. The standard size is rated at 8 amps and has a withdrawal force range of 2 to 16 ounces per contact. The miniature size is specifically for high density applications and is rated at 5 amps with a withdrawal force of 2 to 8 ounces per contact. (For exact specifications, check the individual series listing.)



Miniature Varicon®



Standard Varicon®



## Introduction

---

### CONTACT MATERIAL

The primary contact material used is phosphor bronze. The electrical conductivity of copper alloys are extremely good. Within the Varicon concept, the contacts must also perform as springs and these alloys offer the elastic properties and the endurance required by today's rugged applications.

### CONTACT PLATING

A nickel underplate of 50 to 100 microinches, followed by a minimum of 10 microinches of gold plate is AVX's standard contact plating. The gold plate prevents the formation of insulating oxide films while the nickel plate provides a hard backing. It, in turn, reduces wear on the gold and prevents diffusion between the gold and base metal. Other plating thicknesses, such as those required by military specifications, can be supplied on request.

### VARILOK CRIMP-AND-INSERT CONTACTS

The crimp-termination, insertable / removable Varilok contact offers a solderless connection between wire and contact as well as strain relief for the wire. This contact snaps into the insulator quickly and easily. With our simple tool it can be removed without difficulty, yet it locks securely into place and cannot twist or bend out of alignment.



**Loose Varilok Contacts**



**Reel-Mounted Varilok Contacts**

Varilok contacts also are available with wire-wrappable, solder and taper-tab tail configurations. Available loose for small scale production and replacement purposes, the Varilok contact is also supplied on reels for use with fast, economical automatic crimping machines reducing man-hour requirements and production costs in medium and large-scale production runs. Because the contact can be crimped to the wire and installed into the insulator at any point during the manufacturing operation, it offers the user convenience and flexibility. Reels contain 1800 standard contacts or 3000 miniature contacts.

***All commercial Varicon products are RoHS compliant.***

## Introduction

### MINI-VARILOK

The Mini-Varilok is half the size of the standard Varilok contact. It's designed for hand or machine crimping to solid or stranded AWG #22 to #30 wire. Its basic features are identical to the standard Varilok however it also incorporates a decreased insertion force and is used for high density applications. Production methods for the Mini-Varilok are the same as the standard Varilok.

### CONTACT RETENTION

The Varilok contact, after undergoing five insertion / extraction cycles and being subjected to the vibration and shock tests of MIL-C-28731, still withstands an axial load in excess of 10 pounds (6 for mini-varilok).

### WIRE SIZE

The Varilok contact with its open crimp barrel conforms to practically all specifications written for screw-machined contacts with closed crimp barrels. The crimp barrel of the Varilok contact is designed to accommodate wire sizes AWG #18 to #26. It's also possible to crimp together two stranded #22 or smaller wires. The Mini-Varilok accommodates wire sizes AWG #22 to #30. Table I lists the various sizes of wire to which Varilok contacts can be crimped, and indicates the minimum conductor diameter and the maximum insulator diameter that can be accommodated by the contacts. The crimp barrel is also crimped to the wire's insulation for strain relief and the large, overlapping ears of the barrel accommodate a wide range of wire insulation sizes (Table I). For an optimum crimp connection, the insulation is stripped one-eighth inch from the end of the conductor.

**Table I  
Wire Sizes  
(AWG)**

(Ref: MIL-W-16878/4 – Type E wire)

| Single Wire    | Varilok | Mini-Varilok | Conductor Diameter (Nominal) | Insulator Diameter (Max. Overall) |
|----------------|---------|--------------|------------------------------|-----------------------------------|
| #18            | Yes     | No           | .048                         | .074                              |
| #20            | Yes     | No           | .038                         | .062                              |
| #22            | Yes     | Yes          | .030                         | .054                              |
| #24            | Yes     | Yes          | .024                         | .048                              |
| #26            | Yes     | Yes          | .019                         | .043                              |
| #28            | No      | Yes          | .015                         | .039                              |
| #30 (Stranded) | No      | Yes          | .012                         | .036                              |

### CRIMP CHARACTERISTICS

The illustration shows an enlarged cross-section of a typical Varilok crimp on a #22 stranded wire. No significant voids are visible. The complete deformation of the wire strands indicates optimum contact between the contact barrel and the conductors.

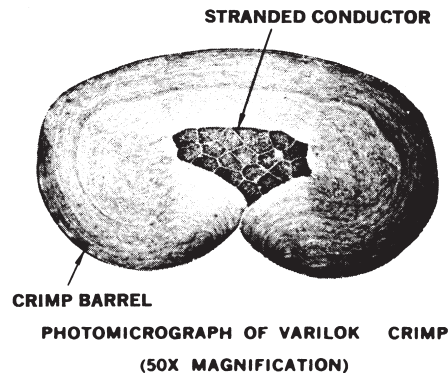

### TENSILE STRENGTH

Table II lists the values, in pounds, of tensile strength (wire pull-out force) for Varilok and Mini-Varilok contacts crimped to stranded AWG #18 to #30 wires.

**Table II  
Tensile Strength  
(In Pounds)**

| Wire Size (AWG) | #18 | #20 | #22 | #24 | #26 | #28 | #30 |
|-----------------|-----|-----|-----|-----|-----|-----|-----|
| Stranded Wire   | 40  | 25  | 15  | 10  | 5   | 3   | 1.5 |

### CRIMPING EQUIPMENT

All equipment needed to crimp Varilok and Mini-Varilok contacts is normally available from stock. Crimping equipment for production crimping as well as hand-operated crimping pliers are designed to realize the full electrical, mechanical and economical advantages of the Varilok and Mini-Varilok contact.

## Series 7008 – 0.100" Staggered Dual Row

### FEATURES

- Available with or without card guides
- Sizes 17, 23, 29, 35, 41
- Wide range of contact terminations
- For 1/16" thick PCB
- Polarization insert
- Mates with Series 7000 and 7022 Plugs

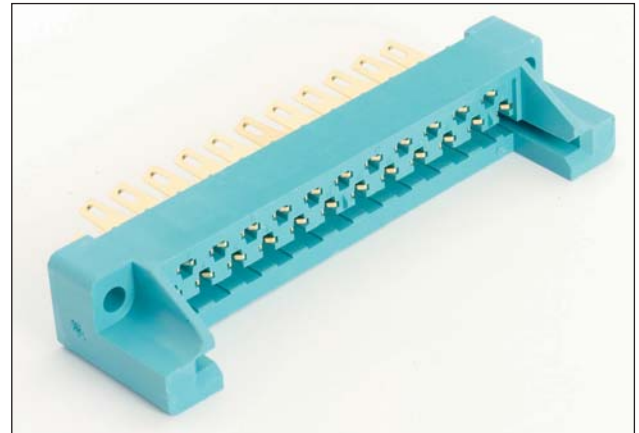

### TECHNICAL SPECIFICATIONS

**Current Rating:**  
10 amperes

**Contact Resistance:**  
6 milliohms, maximum

**Contact Material and Plating:**  
Phosphor Bronze per QQ-B-750, Composition A.

Gold, 10 microinches minimum, over nickel, 30 to 100 microinches

**Insulator Material:**  
Diallyl phthalate, glass-filled, flame resistant, per MIL-M-14F, Type SDGF.

**Insulation Resistance:**  
25,000 megohms, minimum

**Dielectric Withstanding Voltage:**  
Sea Level: 2000 Volts rms  
3.4" Hg: 675 Volts rms

**Insertion/Withdrawal Force:**  
2 to 16 ounces per contact

**Operating Temperature:**  
-40°C to +125°C

### ORDERING CODE

**00**

**7008**

**017**

**Number of Contacts**  
017, 023, 029, 035, 041

**146**

**Contact Code**  
See table.

**001**

**Variation Code**  
See table.

|                     |  |
|---------------------|--|
| 141 = 60 7001 06 33 |  |
| 156 = 60 7001 18 13 |  |
| 163 = 60 7001 19 13 |  |
| 166 = 60 7001 20 23 |  |

| Card Slot | Card Guides | Code |
|-----------|-------------|------|
| 1/16"     | Yes         | 001  |
|           | No          | 002  |

| Connector Description           | Availability |    |    |    |    |
|---------------------------------|--------------|----|----|----|----|
|                                 | 17           | 23 | 29 | 35 | 41 |
| With Guides – for 1/16" Card    | X            | X  | X  | X  | X  |
| Without Guides – for 1/16" Card | X            | X  | X  | X  | X  |

## Series 7008 – 0.100" Staggered Dual Row

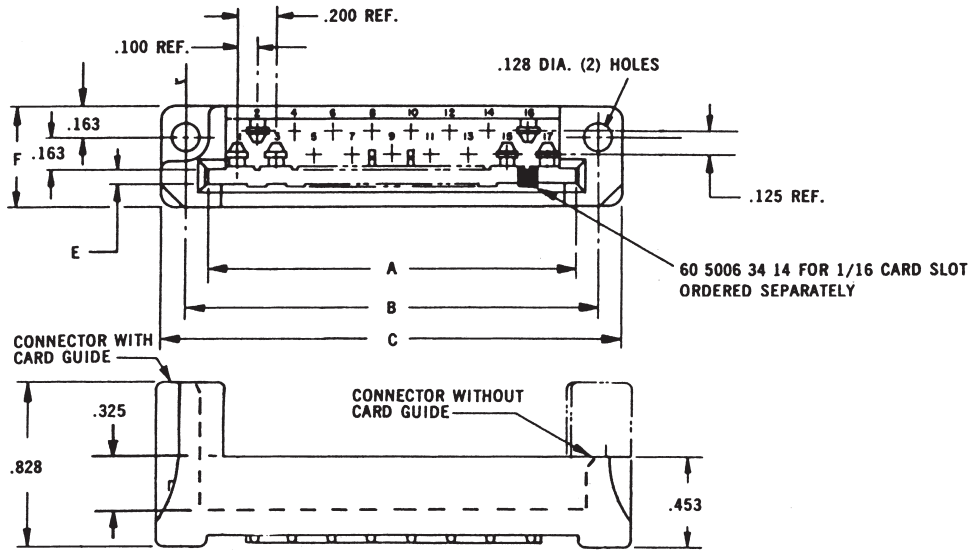

### DIMENSIONS:

millimeters (inches)

| Number of Contacts | A<br>Bottom   | B             | C            | D             | E<br>1/16" Card | F            | G*           |              | H<br>±.003    | L<br>+.010<br>-.000 | N*           |              |
|--------------------|---------------|---------------|--------------|---------------|-----------------|--------------|--------------|--------------|---------------|---------------------|--------------|--------------|
|                    |               |               |              |               |                 |              | Con.         | N-Con.       |               |                     | Con.         | N-Con.       |
| 17                 | 1.920 (0.076) | 2.134 (0.084) | 2.40 (0.094) | 1.835 (0.072) | .074 (0.003)    | .531 (0.021) | .468 (0.018) | .343 (0.014) | 1.600 (0.063) | 1.900 (0.075)       | .210 (0.008) | .148 (0.006) |
| 23                 | 2.520 (0.099) | 2.734 (0.108) | 3.00 (0.118) | 2.435 (0.096) | .074 (0.003)    | .531 (0.021) | .468 (0.018) | .343 (0.014) | 2.200 (0.087) | 2.500 (0.098)       | .210 (0.008) | .148 (0.006) |
| 29                 | 3.120 (0.123) | 3.334 (0.131) | 3.60 (0.142) | 3.035 (0.119) | .074 (0.003)    | .531 (0.021) | .468 (0.018) | .343 (0.014) | 2.800 (0.110) | 3.100 (0.122)       | .210 (0.008) | .148 (0.006) |
| 35                 | 3.270 (0.129) | 3.934 (0.134) | 4.20 (0.165) | 3.635 (0.143) | .074 (0.003)    | .531 (0.021) | .468 (0.018) | .343 (0.014) | 3.400 (0.134) | 3.700 (0.146)       | .210 (0.008) | .148 (0.006) |
| 41                 | 4.320 (0.170) | 4.534 (0.179) | 4.80 (0.190) | 4.235 (0.167) | .074 (0.003)    | .531 (0.021) | .468 (0.018) | .343 (0.014) | 4.000 (0.157) | 4.300 (0.169)       | .210 (0.008) | .148 (0.006) |

\*N-CON = Non-Conductive Chassis  
(1/16" Clearance Around Contacts)

CON = Conductive Chassis  
(1/8" Clearance Around Contacts)

### P.C. CARD LAYOUT

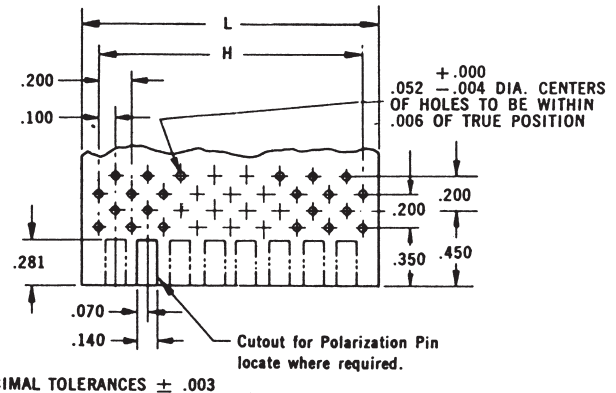
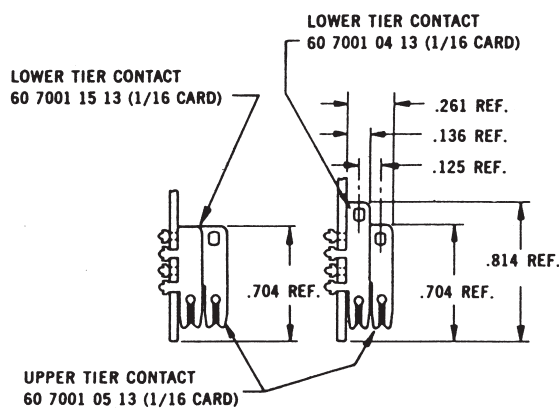

### CHASSIS MOUNTING

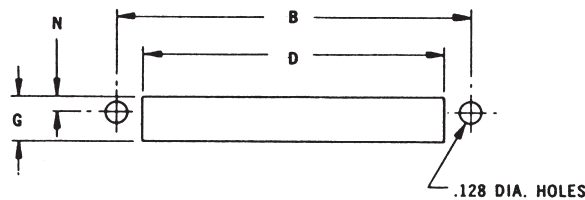



## Series 7022 – 0.100" Staggered Dual Row

### FEATURES

- Insulator rigidity reduces p.c. card warp
- Insulator maintains exact spacing between contacts
- Reduces cost of card punching operation (fewer holes)
- Reduces cost of contact staking operation (one operation instead of two)
- Reduces assembly time (no plastic strip to remove)
- For 1/16" or 3/32" p.c. card
- Mates with Series 7000 Receptacles with or without card guides

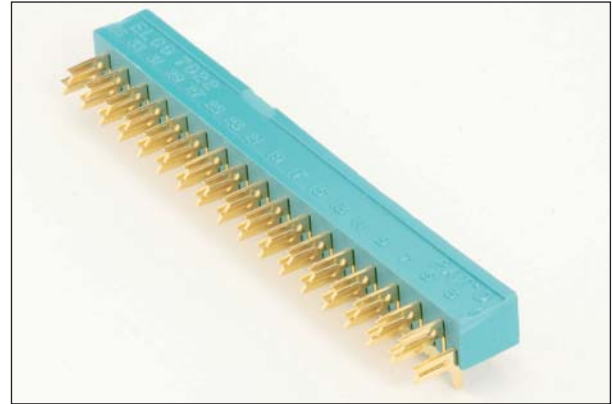

### TECHNICAL SPECIFICATIONS

**Current Rating:**  
10 amperes

**Contact Resistance:**  
6 milliohms, maximum

**Contact Material and Plating:**  
Phosphor Bronze per QQ-B-750, Composition A.

Gold, 10 microinches minimum, over nickel, 30 to 100 microinches

**Insulator Material:**  
Diallyl phthalate, glass-filled, per MIL-M-14F, Type SDGF.  
Variation 001/002  
Thermoplastic Polycarbonate  
Variation 003

**Insulation Resistance:**  
25,000 megohms, minimum

**Dielectric Withstanding Voltage:**  
Sea Level: 2000 Volts rms  
3.4" Hg: 675 Volts rms

**Insertion/Withdrawal Force:**  
2 to 16 ounces per contact

**Operating Temperature:**  
-40°C to +125°C

### ORDERING CODE

00

7022

023

**Number of Contacts**  
017, 023, 029, 035, 041  
For Series 7008 receptacle

000

001

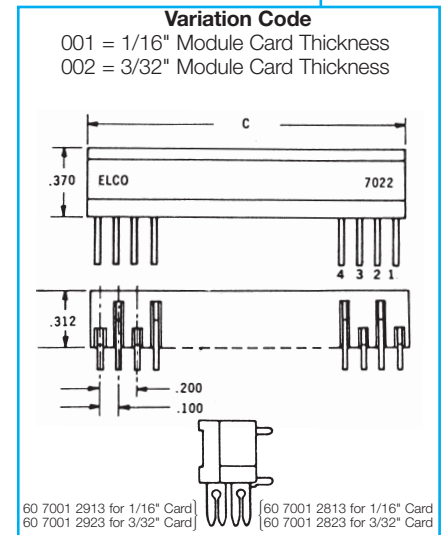

### MOUNTING LAYOUT

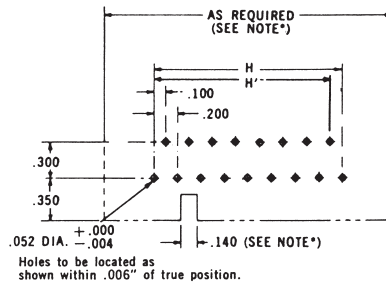

## Series 7023 – 0.100" Staggered Dual Row

### FEATURES

- Guide pins facilitate mating, ensure correct alignment
- Insulator rigidity reduces p.c. card warp
- Insulator maintains exact spacing between contacts
- Reduces cost of card punching operation (fewer holes)
- Reduces cost of contact staking operation (one operation instead of two)
- Reduces assembly time (no plastic strip to remove)
- For 1/16" or 3/32" p.c. card
- Mates with Series 7024 and 7038 Receptacles

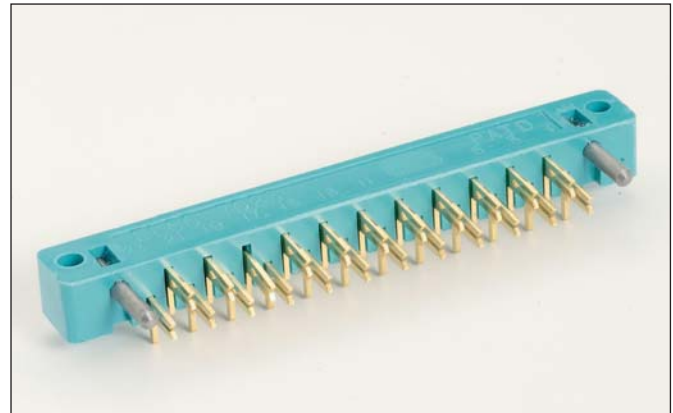

### TECHNICAL SPECIFICATIONS

**Current Rating:**  
10 amperes

**Contact Resistance:**  
6 milliohms, maximum

**Contact Material and Plating:**  
Phosphor Bronze per QQ-B-750,  
Composition A.

Gold, 10 microinches minimum,  
over nickel, 30 to 100 microinches

**Insulator Material:**  
Diallyl phthalate, glass-filled, flame resistant  
per MIL-M-14F, Type SDGF.

Variation 001/002/110/111  
Thermoplastic Polycarbonate  
Variation 003

**Insulation Resistance:**  
25,000 megohms, minimum

**Dielectric Withstanding Voltage:**  
Sea Level: 1800 Volts rms  
3.4" Hg: 675 Volts rms

**Insertion/Withdrawal Force:**  
2 to 16 ounces per contact

**Operating Temperature:**  
-40°C to +125°C

### ORDERING CODE

**00**

**7023**

**023**

**000**

**001**

**Number of Contacts**  
017, 023, 029, 035, 041, 047

### MOUNTING LAYOUT

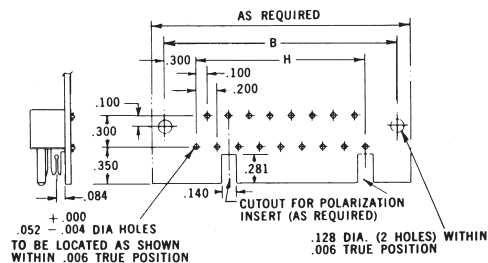

#### Contacts used in this connector:

| Card  | Upper Card Contacts | Lower Card Contacts |
|-------|---------------------|---------------------|
| 1/16" | 60 7001 29 13       | 60 7001 28 13       |
| 3/32" | 60 7001 29 23       | 60 7001 28 23       |

#### Diallyl Phthalate Glass Filled

| 1/16" Card | 3/32" Card |
|------------|------------|
| 001        | 002        |
| 110        | 111        |

### DIMENSIONS: millimeters (inches)

| Number of Contacts | B             | C Max.        | H             |
|--------------------|---------------|---------------|---------------|
| 17                 | 2.200 (0.087) | 2.470 (0.097) | 1.600 (0.063) |
| 23                 | 2.800 (0.110) | 3.070 (0.121) | 2.200 (0.087) |
| 29                 | 3.400 (0.134) | 3.670 (0.144) | 2.800 (0.110) |
| 35                 | 4.000 (0.157) | 4.270 (0.168) | 3.400 (0.134) |
| 41                 | 4.600 (0.181) | 4.870 (0.192) | 4.000 (0.157) |
| 47                 | 5.200 (0.205) | 5.470 (0.215) | 4.600 (0.181) |

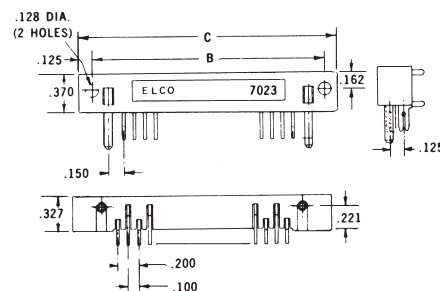

## Series 7024 – 0.100" Staggered Dual Row

### FEATURES

- Guide sockets facilitate mating, ensure correct alignment
- Open-ended card slot; use with p.c. card of any width
- Wide range of contact terminations
- Sizes 17, 23, 29, 35, 41
- For 1/16" or 3/32" p.c. card
- Mates with Series 7023 Plug

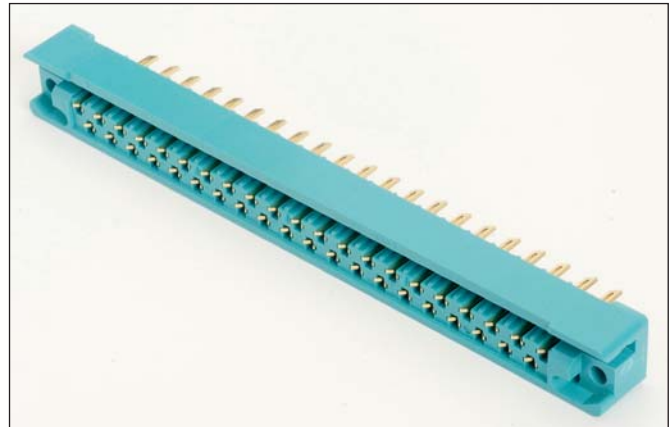

### TECHNICAL SPECIFICATIONS

**Current Rating:**  
10 amperes

**Contact Resistance:**  
6 milliohms, maximum

**Contact Material and Plating:**  
Phosphor Bronze per QQ-B-750, Composition A.

Gold, 10 microinches minimum, over nickel, 30 to 100 microinches

**Insulator Material:**  
Diallyl phthalate, glass-filled, flame resistant, per MIL-M-14F, Type SDGF.

**Insulation Resistance:**  
25,000 megohms, minimum

**Dielectric Withstanding Voltage:**  
Sea Level: 1800 Volts rms  
3.4" Hg: 675 Volts rms

**Insertion/Withdrawal Force:**  
2 to 16 ounces per contact

**Operating Temperature:**  
-40°C to +120°C

### ORDERING CODE

00

7024

023

163

001

**Number of Contacts**  
017, 023, 029, 035, 041

**Contact Code**  
See table.

**Variation Code**  
001 = 1/16" Thick Card  
002 = 3/32" Thick Card  
110 = 1/16" Thick Card 50 mil Gold  
111 = 3/32" Thick Card 50 mil Gold

141 = 60 7001 06 33  
P.C. Termination for 1/8" Card



156 = 60 7001 18 13  
Wire wrapping (.026 x .062 x .600")



163 = 60 7001 19 13  
.098" Base Taper Tab w/Wire Hole



166 = 60 7001 20 23  
Dual Solder Termination for 2 Wires or Bus Line  
(.056 x .125" Slot)



| Connector Description | Availability |    |    |    |    |
|-----------------------|--------------|----|----|----|----|
|                       | 17           | 23 | 29 | 35 | 41 |
| For 1/16" Card        | X            | X  | X  | X  | X  |
| For 3/32" Card        | X            | X  | X  | X  | X  |

## Series 7024 – 0.100" Staggered Dual Row

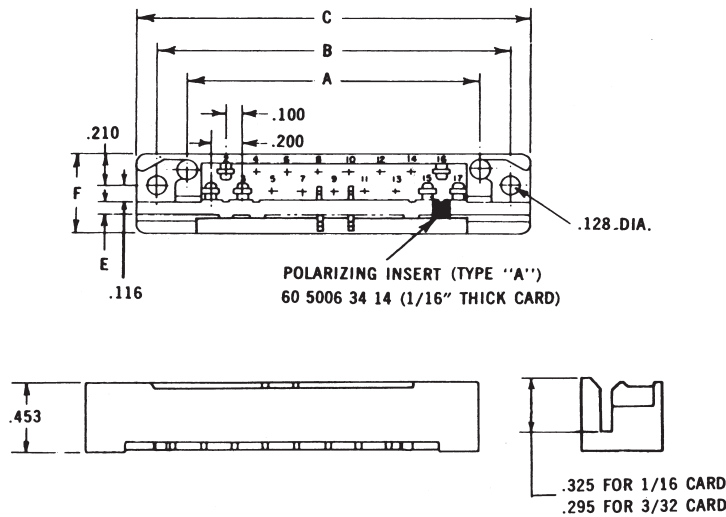

### DIMENSIONS:

millimeters (inches)

| Number of Contacts | A             | B             | C Max.        | D             | E $\pm .003$ / $\pm .002$ |              | F      | G††          |              | H             | N††          |              |
|--------------------|---------------|---------------|---------------|---------------|---------------------------|--------------|--------|--------------|--------------|---------------|--------------|--------------|
|                    |               |               |               |               | 1/16" Card                | 3/32" Card   |        | Con.         | N-Con.       |               | Con.         | N-Con.       |
| 17                 | 1.900 (0.075) | 2.300 (0.091) | 2.570 (0.101) | 1.185 (0.072) | .074 (0.003)              | .105 (0.004) | 17/32" | .468 (0.018) | .343 (0.014) | 1.600 (0.063) | .208 (0.008) | .146 (0.006) |
| 23                 | 2.500 (0.098) | 2.900 (0.114) | 3.170 (0.125) | 2.435 (0.096) | .074 (0.003)              | .105 (0.004) | 17/32" | .468 (0.018) | .343 (0.014) | 2.200 (0.087) | .208 (0.008) | .146 (0.006) |
| 29                 | 3.100 (0.122) | 3.500 (0.138) | 3.770 (0.148) | 3.035 (0.119) | .074 (0.003)              | .105 (0.004) | 17/32" | .468 (0.018) | .343 (0.014) | 2.800 (0.110) | .208 (0.008) | .146 (0.006) |
| 35                 | 3.700 (0.146) | 4.100 (0.161) | 4.370 (0.172) | 3.635 (0.143) | .074 (0.003)              | .105 (0.004) | 17/32" | .468 (0.018) | .343 (0.014) | 3.400 (0.134) | .208 (0.008) | .146 (0.006) |
| 41                 | 4.300 (0.169) | 4.700 (0.185) | 4.970 (0.196) | 4.235 (0.167) | .074 (0.003)              | .105 (0.004) | 17/32" | .468 (0.018) | .343 (0.014) | 4.000 (0.157) | .208 (0.008) | .146 (0.006) |

†† N-CON = Non-Conductive Chassis  
(1/16" Clearance Around Contacts)

CON = Conductive Chassis  
(1/8" Clearance Around Contacts)

### MOUNTING LAYOUT

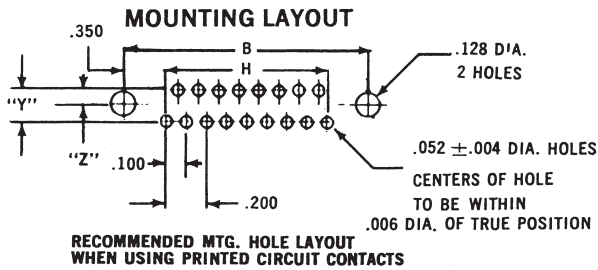

STANDARD CENTERS WHEN "Y" = .125; "Z" = .088

SPECIAL CENTERS WHEN "Y" = .150; "Z" = .100

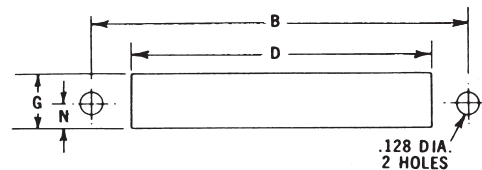

# Varicon®

## Series 7038 – 0.100"

### Staggered Dual Row



## FEATURES

- Varilok® contacts are insertable and removable by user
- Crimp, solderless wrap, tapered tab, and wire hole terminations available
- All crimping, insertion, and extraction equipment available (see page 26)
- Guide sockets facilitate mating, ensure correct alignment
- Open-ended card slot; no p.c. card notching necessary
- Mates with Series 7023 Plug

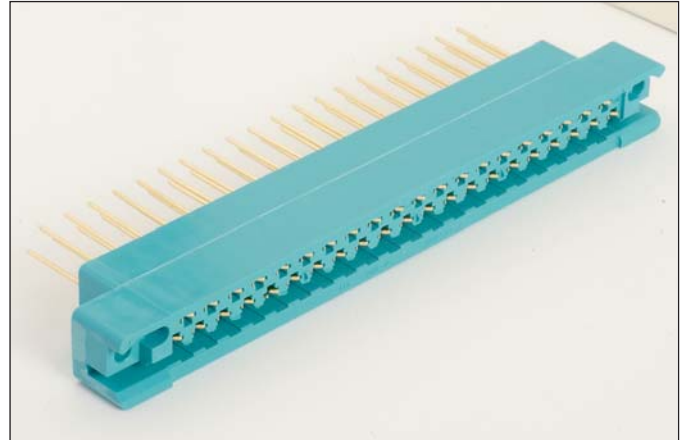

## TECHNICAL SPECIFICATIONS

### Current Rating:

8 amperes

### Contact Resistance:

6 milliohms, maximum

### Contact Material and Plating:

Phosphor Bronze

Gold, 10 microinches minimum, over nickel, 50 to 100 microinches

### Insulator Material:

Diallyl phthalate, glass-filled, flame resistant, per MIL-M-14F, Type SDGF.

### Insulation Resistance:

5,000 megohms, minimum

### Dielectric Withstanding Voltage:

Sea Level: 1800 Volts rms

3.4" Hg: 675 Volts rms

### Insertion/Withdrawal Force:

2 to 16 ounces per contact

### Operating Temperature:

-40°C to +120°C

## ORDERING CODE

00

7038

023

000

001

### Number of Contacts

017, 023, 029,  
035, 041

### Contact Code

See table.

### Variation Code

001 = 1/16" Thick Card  
002 = 3/32" Thick Card  
110 = 1/16" Thick Card 50 mil Gold  
111 = 3/32" Thick Card 50 mil Gold

|  |  |
|--|--|
| 217 = 60 8017 05 13                            |  |
| Wire Hole                                      |  |
| 218 = 60 8017 06 13                            |  |
| Solderless Wrap Tail – .025" x .050" x .567"   |  |
| 750 = 60 8017 06 23                            |  |
| Solderless Wrap Tail – .025" x .050" x .760"   |  |
| 296 = 60 8017 06 33                            |  |
| Solderless Wrap Tail – .025" x .025" x .580"   |  |
| 504 = 60 8017 06 63                            |  |
| Solderless Wrap Tail – .025" x .025" x .170"   |  |
| *000 = 60 8017 03 13                           |  |
| Wire Crimp Tail (Contacts Loose) 18-26 AWG     |  |
| *000 = 60 8017 03 23                           |  |
| Wire Crimp Tail (Contacts on a Reel) 18-26 AWG |  |

\*Order separately by part number, refer to page 25



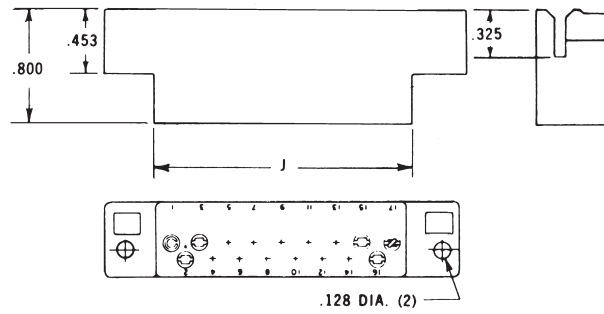
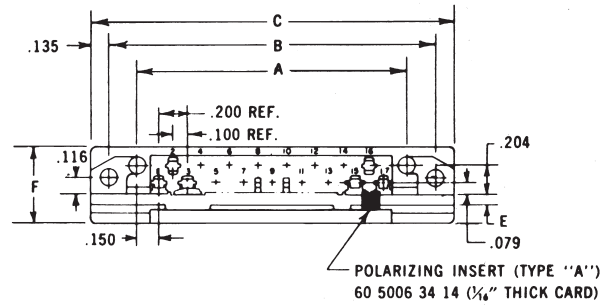

**DIMENSIONS:**

millimeters (inches)

| Number of Contacts | A             | B             | C Max.        | D             | E            |              | F      | G            | J             |
|--------------------|---------------|---------------|---------------|---------------|--------------|--------------|--------|--------------|---------------|
|                    |               |               |               |               | 1/16" Card   | 3/32" Card   |        |              |               |
| 17                 | 1.900 (0.075) | 2.300 (0.091) | 2.570 (0.101) | 1.890 (0.075) | .074 (0.003) | .105 (0.004) | 17/32" | .571 (0.022) | 1.850 (0.073) |
| 23                 | 2.500 (0.099) | 2.900 (0.114) | 3.170 (0.125) | 2.490 (0.098) | .074 (0.003) | .105 (0.004) | 17/32" | .571 (0.022) | 2.450 (0.096) |
| 29                 | 3.100 (0.122) | 3.500 (0.138) | 3.770 (0.148) | 3.090 (0.121) | .074 (0.003) | .105 (0.004) | 17/32" | .571 (0.022) | 3.050 (0.120) |
| 35                 | 3.700 (0.146) | 4.100 (0.161) | 4.370 (0.172) | 3.690 (0.145) | .074 (0.003) | .105 (0.004) | 17/32" | .571 (0.022) | 3.650 (0.144) |
| 41                 | 4.300 (0.169) | 4.700 (0.185) | 4.970 (0.196) | 4.290 (0.169) | .074 (0.003) | .105 (0.004) | 17/32" | .571 (0.022) | 4.250 (0.167) |

**MOUNTING LAYOUT**

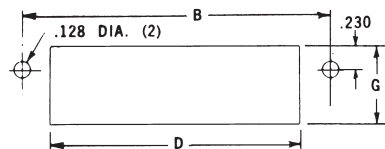

## Series 8016 – .075" x .130" x .150" Grid Pattern

### FEATURES

- Available in five sizes: 20, 38, 56, 90 and 120 contacts
- Insertable / removable Varilok contacts
- Crimp, solder, solderless wrap, and taper tab terminations
- Exceptional versatility: all hardware can be mounted on plug or receptacle (see ordering code)
- Actuating screw facilitates mating and unmating, locks mated connectors together
- Polarizing hardware can be set to any of six positions at factory; can also be reset by user (see polarizing code)
- Optional cover with top or side cable entry and clamp
- Optional cable strain relief clamp with adjustable strap for large or small cable bundles (fits on sizes 38 and 56)
- Plug and receptacle contacts are protected from mishandling
- Guide pins and sockets ensure correct alignment when mating
- Aluminum covers
- CSA acceptable polyester material



### TECHNICAL SPECIFICATIONS

**Current Rating:**

8 amperes, maximum

**Contact Resistance:**

6 milliohms, maximum

**Contact Material:**

Phosphor bronze

**Contact Plating:**

Gold, 10 microinches min.,  
over Nickel,  
50-100 microinches

**Insulator Material:**

Thermoplastic 94V-O glass  
filled polyester

**Insulation Resistance:**

5,000 megohms, min.  
(polyester)

Sea Level: 1250 volts RMS

3.4" Hg: 625 volts RMS

**Cover and Clamp Material and Finish:**

Aluminum with clear chromate under grey  
enamel finish

### CONNECTORS:

**Male**



(Exposed Contacts)

**Female**



(Recessed Contacts)

**Male, Jackscrew**



001/601 Style

**Male, Fixed Nut**



002/602 Style

**Female, Fixed Nut**



007/607 Style

**Female, Jackscrew**



008/608 Style

### COVERS:

**Top Opening**



**Side Opening**



**Top/side Opening  
(Removable Side Plate)**



### CONTACTS:

**Crimp**



**Solder Tab**



217 Style

**Wire Wrap  
14.4mm**



218 Style

**Wire Wrap  
19.3mm**



750 Style

**Wire Wrap  
.567**



296 Style

**Solder**



504 Style

## Series 8016 – Rectangular Connector – 20 Contact

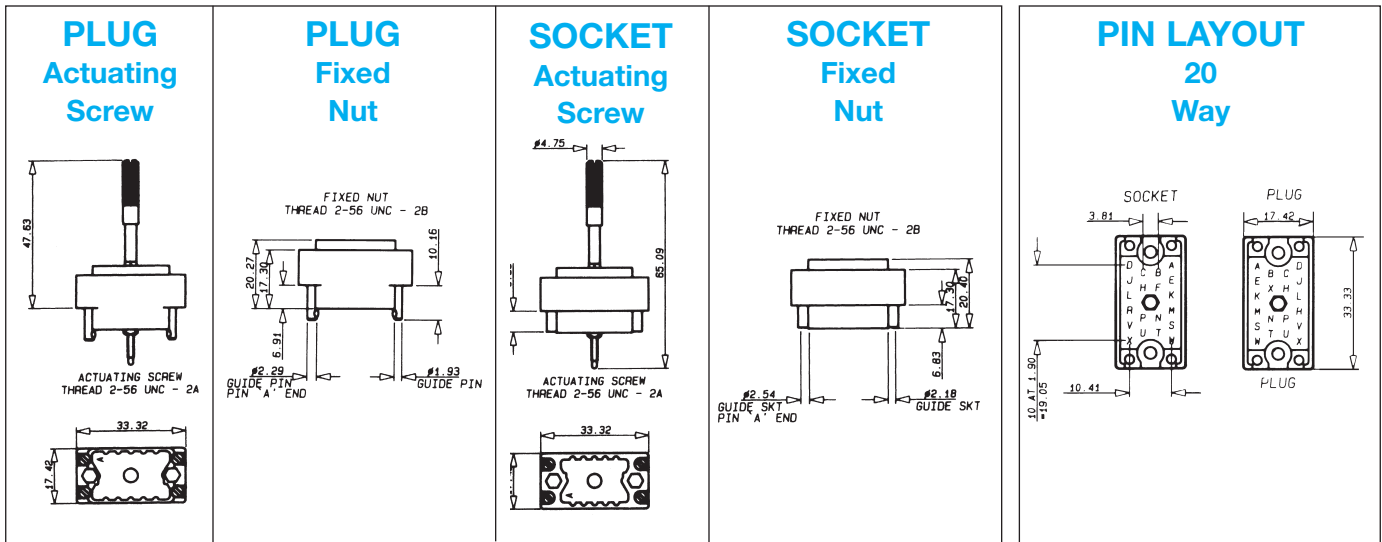

### ORDERING CODE



**Contact Termination**

\*000 = Contacts not fitted and ordered separately, see page 25 for full list of options

217 = Solder 0.098" x 2.49mm

218 = Wire Wrap –   
 0.025 x 0.050 x 0.567" / 0.64 x 1.27 x 14.4mm

296 = Wire Wrap –   
 0.025 x 0.026 x 0.579" / 0.64 x 0.66 x 14.7mm

504 = Solder Tail –

750 = Wire Wrap –   
 0.025 x 0.050 x 0.760" / 0.64 x 1.27 x 19.3mm

\*Crimp contacts always ordered separately. See page 25 for details.

### RECOMMENDED LAYOUT FOR FRONT CHASSIS MOUNTING & PCB LAYOUT

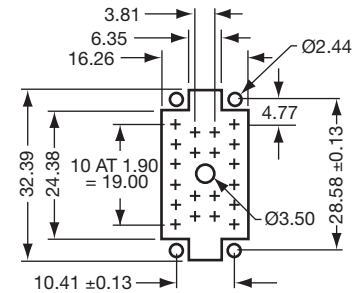

See page 26 for assembly tools.

| 20 CONTACTS         |                     |       |                   |          | COVER         |                |                 |           |
|---------------------|---------------------|-------|-------------------|----------|---------------|----------------|-----------------|-----------|
| Insulator Body Type | Basic P/N*          | Color | Hardware **Thread | No Cover | Top Std Clamp | Side Std Clamp | Actuating Screw | Fixed Nut |
| Male                | 00 8016 020 000 XXX | Green | UNC               | 601      | 603           | 604            | Y               | N         |
| Male                | 00 8016 020 000 XXX | Green | UNC               | 602      | 605           | 606            | N               | Y         |
| Male                | 00 8016 020 000 XXX | Gray  | UNC               | 001      | 903           | 904            | Y               | N         |
| Male                | 00 8016 020 000 XXX | Gray  | UNC               | 002      | 905           | 906            | N               | Y         |
| Female              | 00 8016 020 000 XXX | Green | UNC               | 608      | 609           | 610            | Y               | N         |
| Female              | 00 8016 020 000 XXX | Green | UNC               | 607      | 611           | 612            | N               | Y         |
| Female              | 00 8016 020 000 XXX | Gray  | UNC               | 008      | 909           | 910            | Y               | N         |
| Female              | 00 8016 020 000 XXX | Gray  | UNC               | 007      | 911           | 912            | N               | Y         |

\*Select the column desired and replace the XXX with the numbers from column.

\*\*United Course Thread

## Series 8016 – Rectangular Connector – 38 Contact

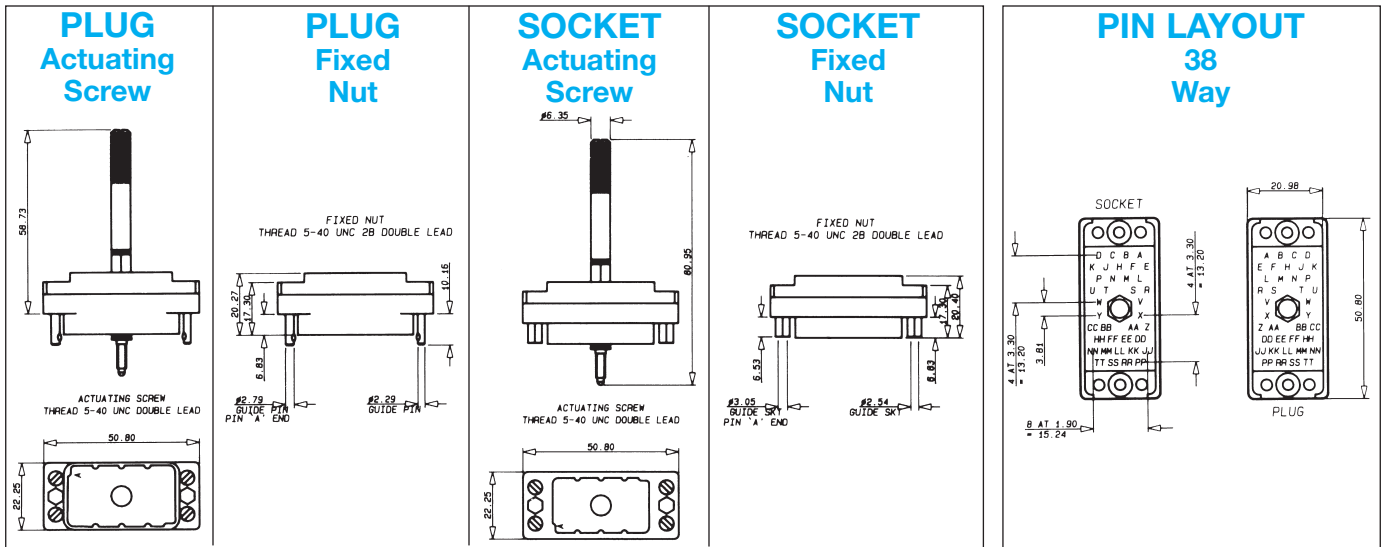

### ORDERING CODE



| Contact Termination   |  |
|---|--|
| *000 = Contacts not fitted and ordered separately, see page 25 for full list of options |  |
| 217 = Solder 0.098" x 2.49mm  |  |
| 218 = Wire Wrap - 0.025 x 0.050 x 0.567" / 0.64 x 1.27 x 14.4mm                         |  |
| 296 = Wire Wrap - 0.025 x 0.026 x 0.579" / 0.64 x 0.66 x 14.7mm                         |  |
| 504 = Solder Tail -   |  |
| 750 = Wire Wrap - 0.025 x 0.050 x 0.760" / 0.64 x 1.27 x 19.3mm                         |  |

\*Crimp contacts always ordered separately. See page 25 for details.

### RECOMMENDED LAYOUT FOR FRONT CHASSIS MOUNTING & PCB LAYOUT

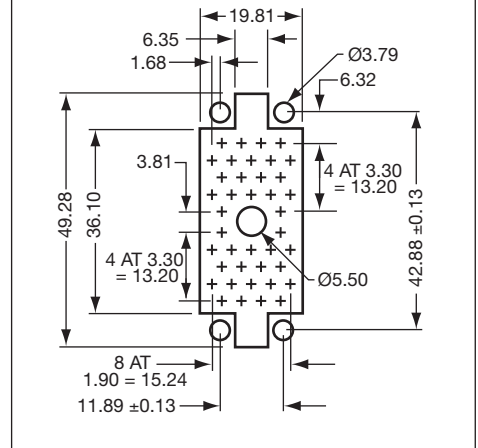

See page 26 for assembly tools.

| 38 CONTACTS         |                     |       |                   |          |               | COVER          |               |                |                  |                   |                 |           |  |
|---------------------|---------------------|-------|-------------------|----------|---------------|----------------|---------------|----------------|------------------|-------------------|-----------------|-----------|--|
| Insulator Body Type | Basic P/N*          | Color | Hardware **Thread | No Cover | Top Std Clamp | Side Std Clamp | Top Lge Clamp | Side Lge Clamp | Top EX Lge Clamp | Side EX Lge Clamp | Actuating Screw | Fixed Nut |  |
| Male                | 00 8016 038 000 XXX | Green | UNC               | 601      | 603           | 604            | 619           | 620            | 631              | 632               | Y               | N         |  |
| Male                | 00 8016 038 000 XXX | Green | UNC               | 602      | 605           | 606            | 621           | 622            | 633              | 634               | N               | Y         |  |
| Male                | 00 8016 038 000 XXX | Gray  | UNC               | 001      | 903           | 904            | 919           | 920            | 931              | 932               | Y               | N         |  |
| Male                | 00 8016 038 000 XXX | Gray  | UNC               | 002      | 905           | 906            | 921           | 922            | 933              | 934               | N               | Y         |  |
| Female              | 00 8016 038 000 XXX | Green | UNC               | 608      | 609           | 610            | 623           | 624            | 635              | 636               | Y               | N         |  |
| Female              | 00 8016 038 000 XXX | Green | UNC               | 607      | 611           | 612            | 625           | 626            | 637              | 638               | N               | Y         |  |
| Female              | 00 8016 038 000 XXX | Gray  | UNC               | 008      | 909           | 910            | 923           | 924            | 935              | 936               | Y               | N         |  |
| Female              | 00 8016 038 000 XXX | Gray  | UNC               | 007      | 911           | 912            | 925           | 926            | 937              | 938               | N               | Y         |  |

\*Select the column desired and replace the XXX with the numbers from column.

\*\*United Course Thread



## Series 8016 – Rectangular Connector – 56 Contact

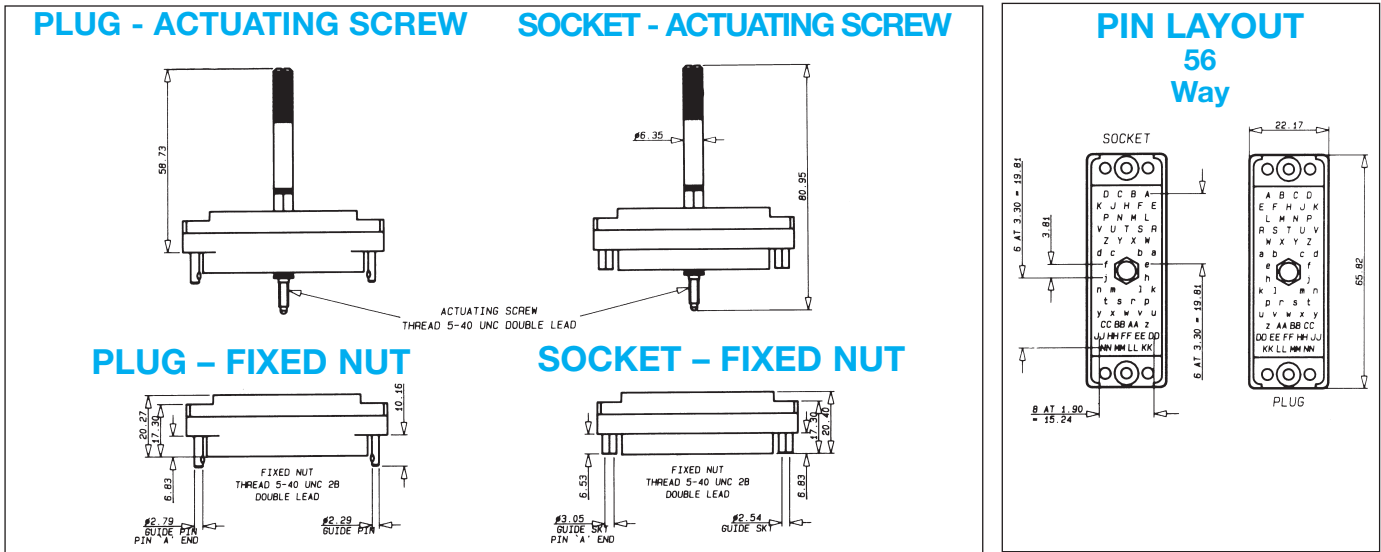

### ORDERING CODE



| Contact Termination   |  |
|---|--|
| *000 = Contacts not fitted and ordered separately, see page 25 for full list of options |  |
| 217 = Solder 0.098" x 2.49mm  |  |
| 218 = Wire Wrap – 0.025 x 0.050 x 0.567" / 0.64 x 1.27 x 14.4mm                         |  |
| 296 = Wire Wrap – 0.025 x 0.026 x 0.579" / 0.64 x 0.66 x 14.7mm                         |  |
| 504 = Solder Tail –   |  |
| 750 = Wire Wrap – 0.025 x 0.050 x 0.760" / 0.64 x 1.27 x 19.3mm                         |  |

\*Crimp contacts always ordered separately. See page 25 for details.

### RECOMMENDED LAYOUT FOR FRONT CHASSIS MOUNTING & PCB LAYOUT

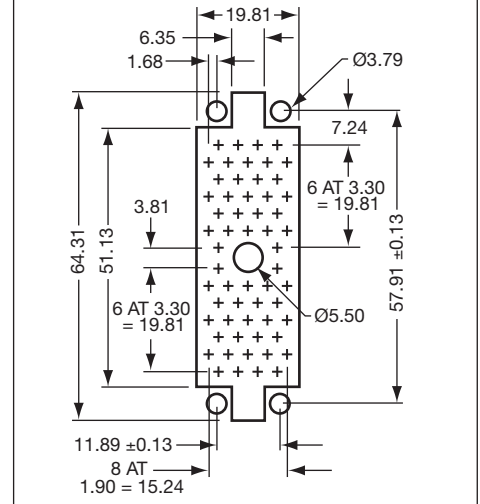

See page 26 for assembly tools.

| 56 CONTACTS         |                     |       |                   |          |                 |           |
|---------------------|---------------------|-------|-------------------|----------|-----------------|-----------|
| Insulator Body Type | Basic P/N*          | Color | Hardware **Thread | No Cover | Actuating Screw | Fixed Nut |
| Male                | 00 8016 056 000 XXX | Green | UNC               | 601      | Y               | N         |
| Male                | 00 8016 056 000 XXX | Green | UNC               | 602      | N               | Y         |
| Male                | 00 8016 056 000 XXX | Gray  | UNC               | 001      | Y               | N         |
| Male                | 00 8016 056 000 XXX | Gray  | UNC               | 002      | N               | Y         |
| Female              | 00 8016 056 000 XXX | Green | UNC               | 608      | Y               | N         |
| Female              | 00 8016 056 000 XXX | Green | UNC               | 607      | N               | Y         |
| Female              | 00 8016 056 000 XXX | Gray  | UNC               | 008      | Y               | N         |
| Female              | 00 8016 056 000 XXX | Gray  | UNC               | 007      | N               | Y         |

\*Select the column desired and replace the XXX with the numbers from column.  
 \*\*United Course Thread

## Series 8016 – Rectangular Connector – 90 Contact

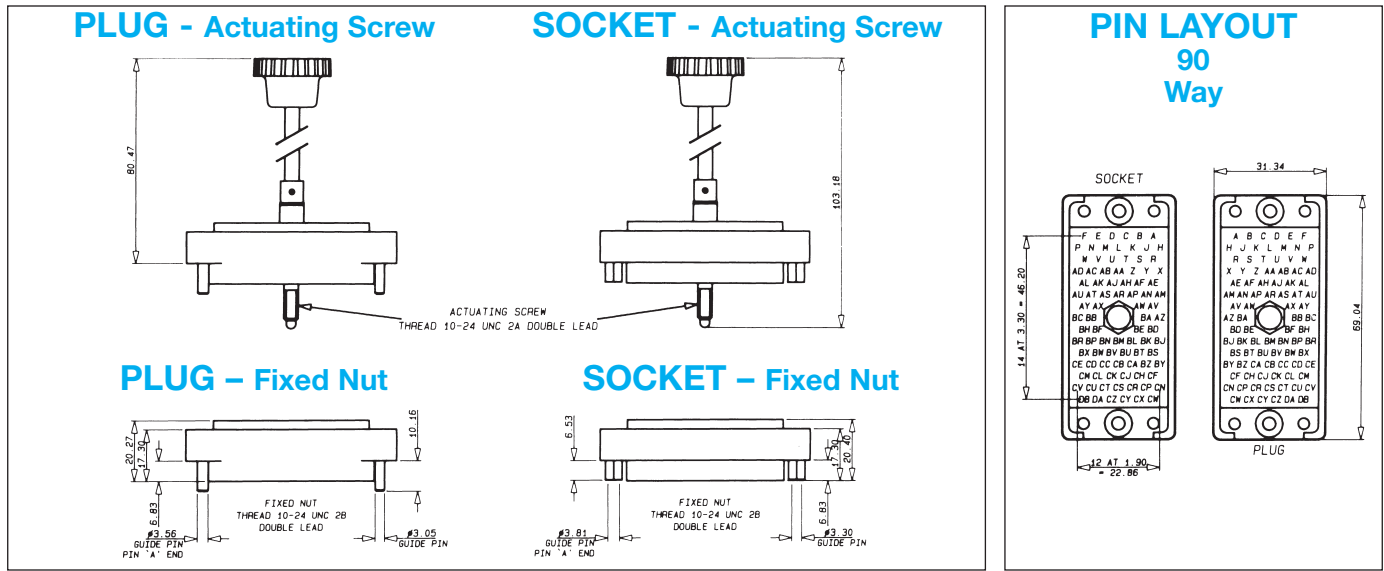

### ORDERING CODE



**Contact Termination**

\*000 = Contacts not fitted and ordered separately, see page 25 for full list of options

217 = Solder 0.098" x 2.49mm

218 = Wire Wrap –   
0.025 x 0.050 x 0.567" / 0.64 x 1.27 x 14.4mm

296 = Wire Wrap –   
0.025 x 0.026 x 0.579" / 0.64 x 0.66 x 14.7mm

504 = Solder Tail –

750 = Wire Wrap –   
0.025 x 0.050 x 0.760" / 0.64 x 1.27 x 19.3mm

\*Crimp contacts always ordered separately. See page 25 for details.

### RECOMMENDED LAYOUT FOR FRONT CHASSIS MOUNTING & PCB LAYOUT

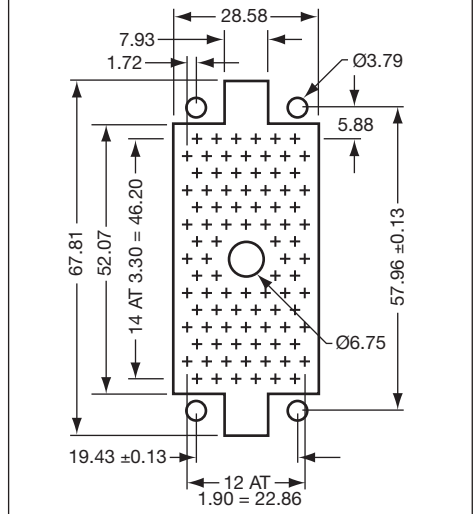

See page 26 for assembly tools.

| 90 CONTACTS         |                     |       |                   |          | COVER         |                |                  |                   | Actuating Screw | Fixed Nut |
|---------------------|---------------------|-------|-------------------|----------|---------------|----------------|------------------|-------------------|-----------------|-----------|
| Insulator Body Type | Basic P/N*          | Color | Hardware **Thread | No Cover | Top Lge Clamp | Side Lge Clamp | Top EX Lge Clamp | Side EX Lge Clamp |                 |           |
| Male                | 00 8016 090 000 XXX | Green | UNC               | 601      | 603           | 604            | 631              | 632               | Y               | N         |
| Male                | 00 8016 090 000 XXX | Green | UNC               | 602      | 605           | 606            | 633              | 634               | N               | Y         |
| Male                | 00 8016 090 000 XXX | Gray  | UNC               | 001      | 903           | 904            | 931              | 932               | Y               | N         |
| Male                | 00 8016 090 000 XXX | Gray  | UNC               | 002      | 905           | 906            | 933              | 934               | N               | Y         |
| Female              | 00 8016 090 000 XXX | Green | UNC               | 608      | 609           | 610            | 635              | 636               | Y               | N         |
| Female              | 00 8016 090 000 XXX | Green | UNC               | 607      | 611           | 612            | 637              | 638               | N               | Y         |
| Female              | 00 8016 090 000 XXX | Gray  | UNC               | 008      | 909           | 910            | 935              | 936               | Y               | N         |
| Female              | 00 8016 090 000 XXX | Gray  | UNC               | 007      | 911           | 912            | 937              | 938               | N               | Y         |

\*Select the column desired and replace the XXX with the numbers from column.

\*\*United Course Thread



## Series 8016 Covers

| Part Number         | For Size | Hardware Threads | Cable Entrance | Clamp Type | Size mm (inches)              |
|---------------------|----------|------------------|----------------|------------|-------------------------------|
| 30 8016 9829 00 000 | 20       | Metric           | Side           | Standard   | 11.53 (0.454) Dia             |
| 30 8016 9831 00 000 | 20       | Metric           | Top            | Standard   | 11.53 (0.454) Dia             |
| 30 8016 0200 00 415 | 20       | UNC              | 45             | Standard   | 5 x 10 (0.197 x 0.394) min    |
| 30 8016 9821 00 000 | 38       | Metric           | Side           | Standard   | 16.51 x 12.70 (0.650 x 0.500) |
| 30 8016 9822 00 000 | 38       | Metric           | Top            | Standard   | 16.51 x 12.70 (0.650 x 0.500) |
| 30 8016 9825 00 000 | 38       | Metric           | Side           | Large      | 16.51 x 15.44 (0.650 x 0.608) |
| 30 8016 9826 00 000 | 38       | Metric           | Top            | Large      | 16.51 x 15.44 (0.650 x 0.608) |
| 30 8016 9838 00 000 | 38       | Metric           | Side           | Ex-Large   | 20.83 x 15.60 (0.820 x 0.614) |
| 30 8016 9839 00 000 | 38       | Metric           | Top            | Ex-Large   | 20.83 x 15.60 (0.820 x 0.614) |
| 30 8016 0560 00 413 | 56       | UNC              | Top/Side       | Standard   | 6 x 14 (0.236 x 0.551) min    |
| 30 8016 9832 00 000 | 90       | Metric           | Side           | Large      | 20.32 (0.800) Dia             |
| 30 8016 9833 00 000 | 90       | Metric           | Top            | Large      | 20.32 (0.800) Dia             |
| 30 8016 9843 00 000 | 90       | Metric           | Side           | Ex-Large   | 25.40 x 20.32 (1.00 x 0.800)  |
| 30 8016 9844 00 000 | 90       | Metric           | Top            | Ex-Large   | 25.40 x 20.32 (1.00 x 0.800)  |
| 30 8016 9834 00 000 | 120      | Metric           | Side           | Large      | 20.32 x 27.43 (0.800 x 1.080) |
| 30 8016 9835 00 000 | 120      | Metric           | Top            | Large      | 20.32 x 27.43 (0.800 x 1.080) |

## Series 8016 Covers

### CLAMPING AND COVER DIMENSIONS      OPTIONAL REMOVABLE SIDE PLATE COVER 20 CONTACTS

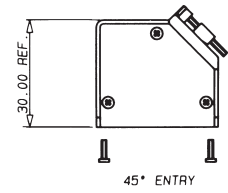
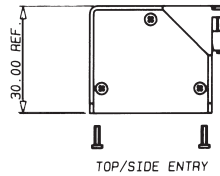
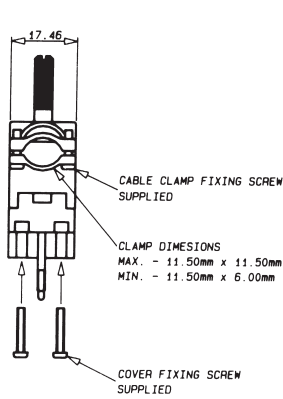
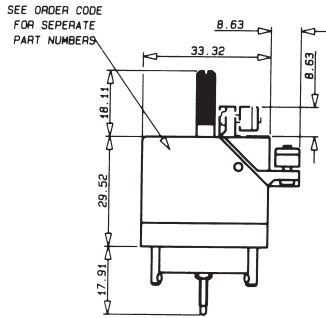

| Part Number     | Opening  |
|-----------------|----------|
| 308016020000413 | Side/Top |
| 308016020000415 | 45°      |

| CLAMP                  |                         |
|------------------------|-------------------------|
| Minimum Size           | Maximum Size            |
| 5 x 10 (0.197 x 0.394) | 10 x 10 (0.394 x 0.394) |
| 5 x 10 (0.197 x 0.394) | 10 x 10 (0.394 x 0.394) |

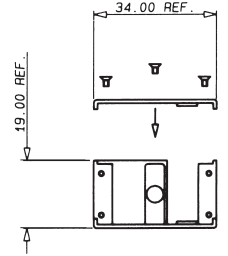

### 38 CONTACTS

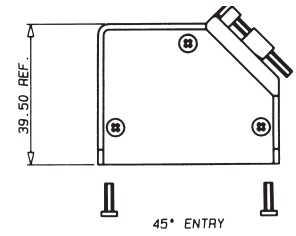
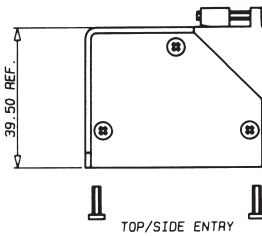
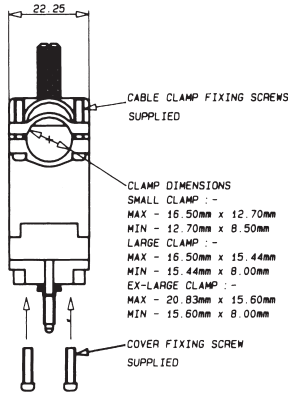
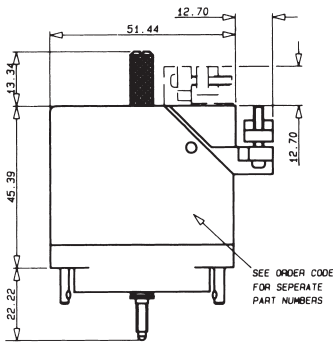

| Part Number     | Opening  |
|-----------------|----------|
| 308016038000413 | Side/Top |
| 308016038000415 | 45°      |

| CLAMP                  |                         |
|------------------------|-------------------------|
| Minimum Size           | Maximum Size            |
| 6 x 14 (0.236 x 0.551) | 17 x 14 (0.669 x 0.551) |
| 6 x 14 (0.236 x 0.551) | 17 x 14 (0.669 x 0.551) |

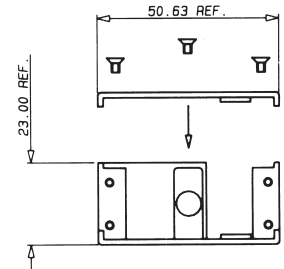

### 56 CONTACTS

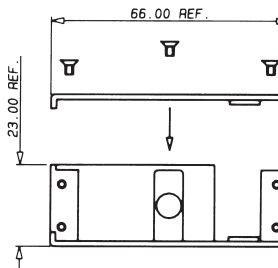
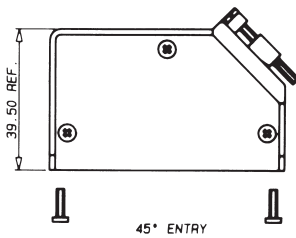

| Part Number     | Opening  |
|-----------------|----------|
| 308016056000413 | Side/Top |

| CLAMP                  |                         |
|------------------------|-------------------------|
| Minimum Size           | Maximum Size            |
| 6 x 14 (0.236 x 0.551) | 17 x 14 (0.669 x 0.551) |
| 6 x 14 (0.236 x 0.551) | 17 x 14 (0.669 x 0.551) |



### CLAMPING AND COVER DIMENSIONS

#### 90 CONTACTS

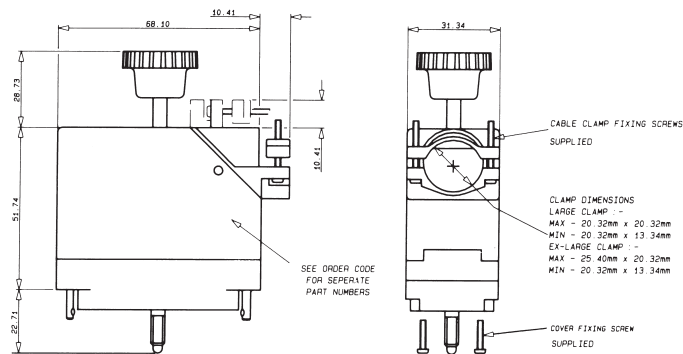

#### 120 CONTACTS

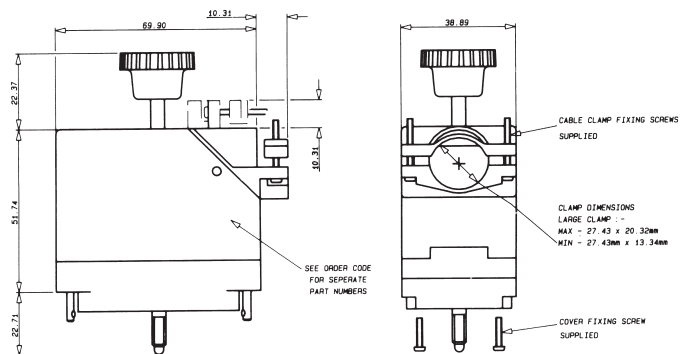

See page 21 for part numbers

### 75/100/130 CONTACTS

Plug with Actuating Screw 001

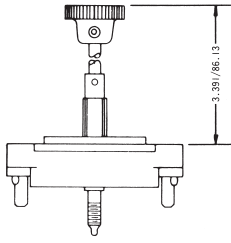

Receptacle with Fixed Nut 007

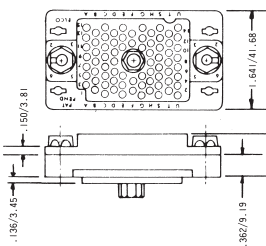

Plug with Fixed Screw 002

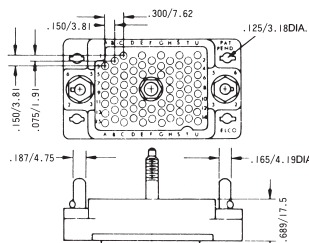

Receptacle with Actuating Nut 008

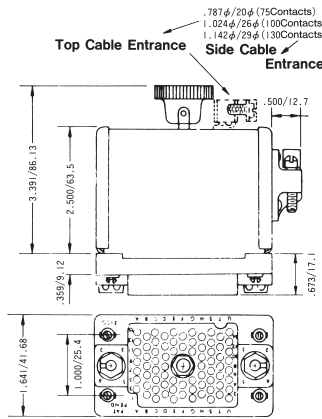

### 75 CONTACTS

Plug

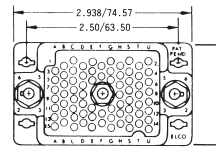

Receptacle

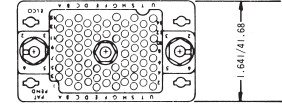

### 100 CONTACTS

Plug

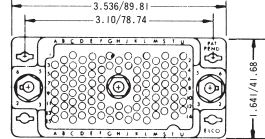

Receptacle

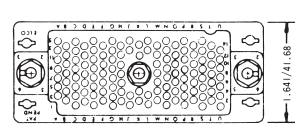

### 130 CONTACTS

Plug

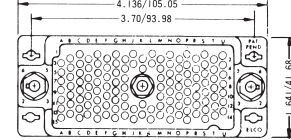

Receptacle

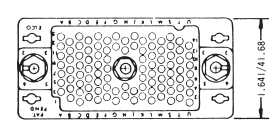

### ORDERING CODE

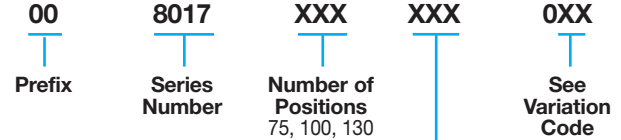

### RECOMMENDED CHASSIS LAYOUT

Layout for Front Chassis Mounting

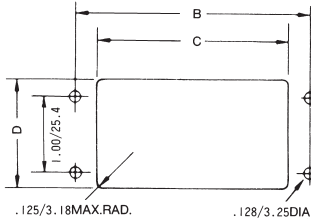

Layout for Back Chassis Mounting

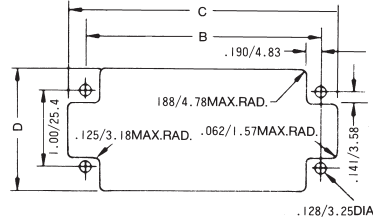

All Tolerances  $\pm .005 \pm .127$

| No. of Pos. | Front Chassis Mtg. |             |             | Back Chassis Mtg. |              |             |
|-------------|--------------------|-------------|-------------|-------------------|--------------|-------------|
|             | B                  | C           | D           | B                 | C            | D           |
| 75          | 2.500/63.50        | 1.953/49.61 | 1.437/36.50 | 2.500/63.50       | 2.953/75.00  | 1.656/42.06 |
| 100         | 3.100/78.74        | 2.546/64.67 | 1.437/36.50 | 3.100/78.74       | 3.562/90.47  | 1.656/42.06 |
| 130         | 3.700/93.98        | 3.156/80.16 | 1.437/36.50 | 3.700/93.98       | 4.156/105.56 | 1.656/42.06 |

Dimensions inches/mm

### VARIATION CODE

| Insulator Body Type | Variation Code No. | Cover & Cable Entrance | Actuating Screw | Fixed Screw |
|---------------------|--------------------|------------------------|-----------------|-------------|
| Plug                | 001                | No                     | Yes             | No          |
|                     | 002                | No                     | No              | Yes         |
|                     | 003                | Top                    | Yes             | No          |
|                     | 004                | Side                   | Yes             | No          |
|                     | 005                | Top                    | No              | Yes         |
|                     | 006                | Side                   | No              | Yes         |

| Insulator Body Type | Variation Code No. | Cover & Cable Entrance | Fixed Nut | Actuating Nut |
|---------------------|--------------------|------------------------|-----------|---------------|
| Receptacle          | 007                | No                     | Yes       | No            |
|                     | 008                | No                     | No        | Yes           |
|                     | 009                | Top                    | Yes       | No            |
|                     | 010                | Side                   | Yes       | No            |
|                     | 011                | Top                    | No        | Yes           |
|                     | 012                | Side                   | No        | Yes           |





### CONNECTOR PLUG AND RECEPTACLE COMBINATIONS

| Plug | Receptacle |     |     |     |     |     |
|------|------------|-----|-----|-----|-----|-----|
|      | 007        | 008 | 009 | 010 | 011 | 012 |
| 001  |            |     |     |     |     |     |
| 002  |            |     |     |     |     |     |
| 003  |            |     |     |     |     |     |
| 004  |            |     |     |     |     |     |
| 005  |            |     |     |     |     |     |
| 006  |            |     |     |     |     |     |

## Loose Contacts

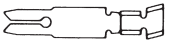
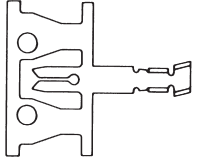
Varilok® connectors can be specified as either fully loaded, to include the connector body and a variety of pre-loaded contact termination types or the empty body and a selection

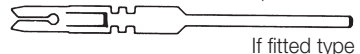
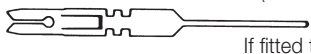
of separately specified and ordered contacts. The table below details the various loose contacts available.

| Contact Style  | Description   | Plating Specification  | Order Code   |
|--|---|--|--|
|  <p>*<br/>Ordered separately</p>  | Crimp Contact Loose                                   | 0.25µM Gold All Over (Standard)<br>0.25µM Gold Nose & Tail (Optional)  | 60 8017 0313 00 339<br>60 8017 0313 00 042   |
|  <p>Ordered separately</p>  | Crimp Contact End Carrier<br>(1800 Contacts per reel) | 0.25µM Gold All Over (Standard)<br>0.25µM Gold Nose & Tail (Optional)<br>0.25µM Gold All Over (Standard)<br>0.25µM Gold Nose & Tail (Optional) | 60 8017 0323 99 339<br>60 8017 0323 99 042<br>60 8017 0323 00 339**<br>60 8017 0323 00 042** |
| <p>Tail Section – 2.49 x 0.61 (0.098 x 0.024)</p>  <p>*<br/>If fitted type 217</p>    | Solder Tag Contact                                    | 0.25µM Gold All Over (Standard)  | 60 8017 0513 00 339  |
| <p>Tail Section – 1.27 x 0.63 (0.025 x 0.005)</p>  <p>If fitted type 218</p>          | 14.4mm Maxiwrap Contact                               | 0.25µM Gold All Over (Standard)  | 60 8017 0613 00 339  |
| <p>Tail Section – 1.27 x 0.63 (0.025 x 0.005)</p>  <p>If fitted type 750</p>          | 19.3mm Maxiwrap Contact                               | 0.25µM Gold All Over (Standard)  | 60 8017 0623 00 339  |
| <p>Tail Section – 0.635 x 0.63 (0.025 x 0.005)</p>  <p>If fitted type 296</p>       | 14.0 Miniwrap Contact                                 | 0.25µM Gold All Over (Standard)  | 60 8017 0633 00 339  |
| <p>Tail Section – 0.635 x 0.63 (0.025 x 0.005)</p>  <p>*<br/>If fitted type 504</p> | 4.3mm PC Solder Contact<br>for ø 1.00 mm P.T.H.       | 0.25µM Gold All Over (Standard)  | 60 8017 0663 00 339  |

\* Indicates standard contact

Plating code 343 = 0.50 µm Gold all over

\*\* Order code to be used when purchasing through a USA source.

## CONNECTOR POLARIZATION

Varicon® 8016 Series connectors are designed with an integral polarizing system to ensure in high density environments that the correct halves are mated together.

As a factory standard, male plugs are set to the code PG1G1, with the female receptacles being set to the opposite matching code RS1S1.

Customers who need to change the standard polarization to another position can do so by ordering the connectors with the required polarization (eg: PG1G4 or RS2S5, etc) When ordering a different polarization from normal, the polarization is called out at the end of the part number (Ex: 00 8016 056 000 601PG2G4, etc).

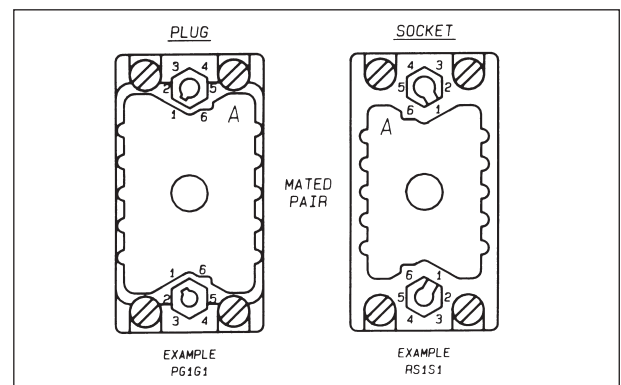

## ORDERING CODE

**P**  
Type of Connector Half  
Plug = P  
Socket = R

**G**  
Location Side  
(Large Dia.)  
Guide Pin = G  
Guide Socket = S

**1**  
Positions  
1 through 6

**G**  
Location Side  
(Small Dia.)  
Guide Pin = G  
Guide Socket = S

**1**  
Positions  
1 through 6

## Tools

### CONTACT INSERTION TOOLS

These are small hand tools which provide a positive method for inserting contacts into the rear of the insulator by applying pressure on the contacts directly to the end of the insulation crimp.

| Tool                | Contact Capability         | Connector Series       |
|---------------------|----------------------------|------------------------|
| 06 1742 0400 00 000 | Varilok®                   |                        |
|                     | No. 60 8017 Contact Family | 7038, 8016, 8017, 8020 |



### HAND CRIMP TOOLS

This tool is designed for hand crimping of contacts. The tool is well suited for maintenance, model shop, laboratory and small scale production purposes. Two crimping cavities are available; Upper Cavity will crimp wire 18-20 AWG and the Lower Cavity will crimp wire 22-26 AWG.



| Part No.                             | Contact Capability | Wire Type & Size |
|--------------------------------------|--------------------|------------------|
| 06 7852 0100 00 000<br>(Standard)    | Varilok®           | Stranded AWG     |
|                                      | No. 60 8017 0313   | No. 18-26        |
| 06 7852 7002 01 000<br>(Blue Handle) | Varilok®           | Stranded AWG     |
|                                      | No. 60 8017 0313   | No. 18-26        |
| 06 7858 01 000 0000                  | Mini Varilok®      | Stranded AWG     |
|                                      | No. 60 8216 0313   | No. 22-30        |

### CONTACT EXTRACTION TOOLS

This tool is designed to extract contacts from the front of the insulator quickly and easily, without damage to either contacts or insulator.



| Tool                | Contact Capability         | Connector Series       |
|---------------------|----------------------------|------------------------|
| 06 1877 0400 00 000 | Varilok®                   |                        |
|                     | No. 60 8017 Contact Family | 7038, 8016, 8017, 8020 |
| 06 7699 01 000 0000 | Mini Varilok®              |                        |
|                     | No. 60 8216 Contact Family | 8223                   |

## Series 8020 – Cable Connector

### APPLICATION

In line connection of 2 or 3 wire of 18-26 AWG, insulation  $\phi$ 1.03 mm to 1.88 mm.

### FEATURES AND BENEFITS

- 2 and 3 position in single row
- Uses identical molding for plug and socket
- Uses identical contact for plug and socket
- Uses standard Varicon 8016 contacts
- Uses standard Varicon Crimping Tools, Contact Extraction Tools and Insertion Tools
- Has combined nylon mounting and locking clip common to both sizes
- Contacts for both solder and crimp termination

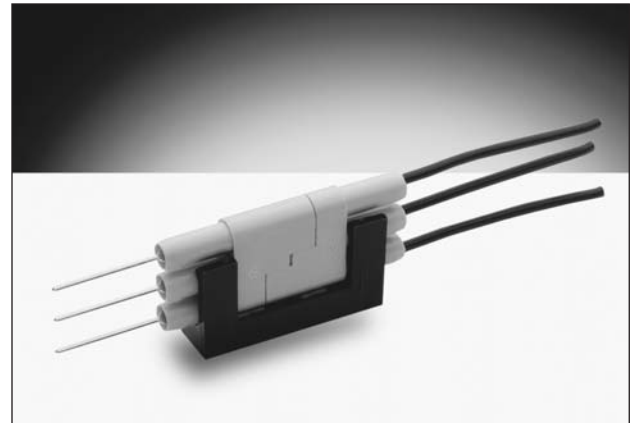

### TECHNICAL SPECIFICATIONS

**Contact:**

Single row of 2 or 3 Varilok contacts

**Contact Rating:**

8.5 amperes

**Insulation Resistance:**

5,000 megohms (min)

**Configuration:**

On a 0.200 inch pitch, 5.08 mm

**Contact Resistance:**

6 milliohms (max)

**Voltage Proof:**

2,500 volts R.M.S. Sea Level

### CONNECTOR DIMENSIONS (mm)

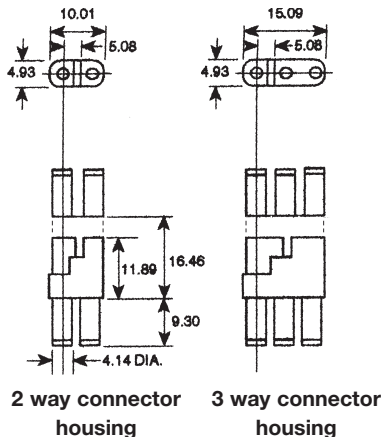

### LOCKING CLIP DIMENSIONS (mm)

P/N 608020321000000

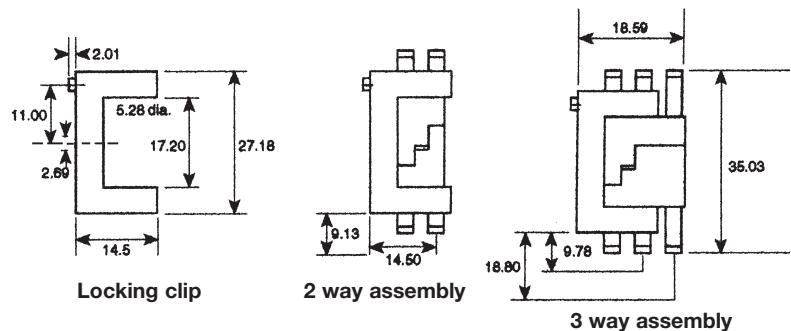

### ORDERING CODE FOR COMPLETE CONNECTORS WITH NON-CRIMP CONTACTS FITTED

|           |               |                                  |  |                |
|-----------|---------------|----------------------------------|--|----------------|
| <b>00</b> | <b>8020</b>   | <b>002</b>                       | <b>217</b>   | <b>001</b>     |
| Prefix    | Series Number | Number of Contacts               | *Contact Termination   | Variation Code |
|           |               | 002 = Two way<br>003 = Three way | 000 = Crimp Contacts (Ordered Separately)<br>217 = Solder Tag<br>218 = Wire Wrap (0.61 x 1.27 x 14.4mm)<br>296 = Mini Wire Wrap (0.61 x 0.66 x 4.73mm)<br>504 = Solder Tail (0.61 x 0.66 x 4.32mm) |                |

\*Contact terminations should be insulated because they may protrude from the insulator.

NB: See page 25 for details of contacts.

### ORDERING CODE FOR HOUSINGS AND CRIMP CONTACTS

| Description  | Part Number         | Description   | Part Number         |
|--|---------------------|---|---------------------|
| 2 way connector: Housing only                          | 60-8020-3117-00-000 | 0.25 $\mu$ M Gold reeled crimp contacts (gold all over) | 60-8017-0323-99-339 |
| 3 way connector: Housing only                          | 60-8020-3317-00-000 | 0.25 $\mu$ M Gold reeled crimp contacts (selective)     | 60-8017-0323-99-042 |
| 0.25 $\mu$ M Gold loose crimp contacts (gold all over) | 60-8017-0313-00-339 | NB: See page 25 for details of crimp contacts           |                     |
| 0.25 $\mu$ M Gold loose crimp contacts (selective)     | 60-8017-0313-00-042 | Locking clip  | 60-8020-3210-00-000 |



## Series 8218 – 0.050" Staggered Dual Row

### FEATURES

- High contact density
- For parallel or perpendicular p.c. card mounting
- High mounting density (.050" centers, minimum)
- Nylon end sections for mounting and card guidance
- Mounting hardware supplied with connector
- Mates with 8219 Series

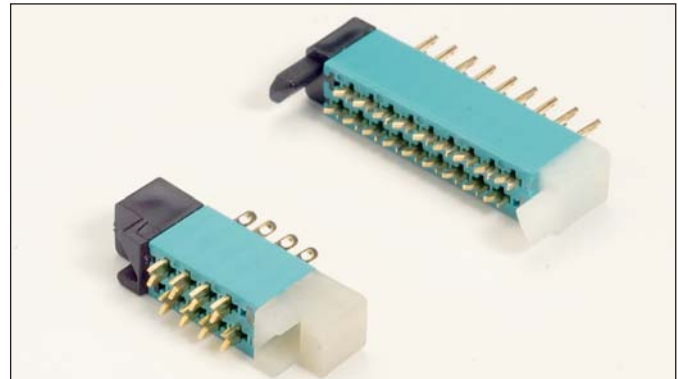

### TECHNICAL SPECIFICATIONS

**Current Rating:**

5 amperes, maximum

**Contact Resistance:**

0.005 ohm, maximum

**Contact Material and Plating:**

Phosphor Bronze  
nickel plate, 30 to 50 microinches followed by  
gold plate, 10 to 20 microinches

**Insulator Material:**

Diallyl phthalate, glass-filled, flame resistant,  
end guides: nylon

**Insulation Resistance:**

5,000 megohms, minimum

**Dielectric Withstanding Voltage:**

Sea Level: 1000 Volts rms  
3.4" Hg: 500 Volts rms

**Insertion/Withdrawal Force:**

2 to 16 ounces per contact

### ORDERING CODE

**00**

**8218**

**076**

**000**

**001**

**Number of Contacts**

002 to 076 for connectors  
without center guide

**Contact Code**

**Variation Code**

001 = Receptacle  
002 = Plug-Card  
005 = Plug-Board

**with keying pins**

011 = Receptacle  
012 = Plug-Card/pin  
inserted in  
odd position  
013 = Plug-Card/pin  
inserted in even  
position  
017 = Plug-Board

**with keying holes**

021 = Receptacle  
022 = Plug-Card/pin  
inserted in  
odd position  
023 = Plug-Card/pin  
inserted in even  
position  
027 = Plug-Board

**Variant 002 right angled contacts**

000 = 60 8200 16 33 P.C. Tail

000 = 60 8200 16 63 P.C. Tail

**Variants 001 and 005**

722 = 60 8200 16 13 Wire Hole Tail

736 = 60 8200 16 33 P.C. Tail (X = 9/32", Y = 1/4")

753 = 60 8200 16 53 P.C. Tail (X = 1/8", Y = 3/32")

771 = 60 8200 16 63 P.C. Tail (X = 31/64", Y = 29/64")

## Series 8218 – 0.050" Staggered Dual Row

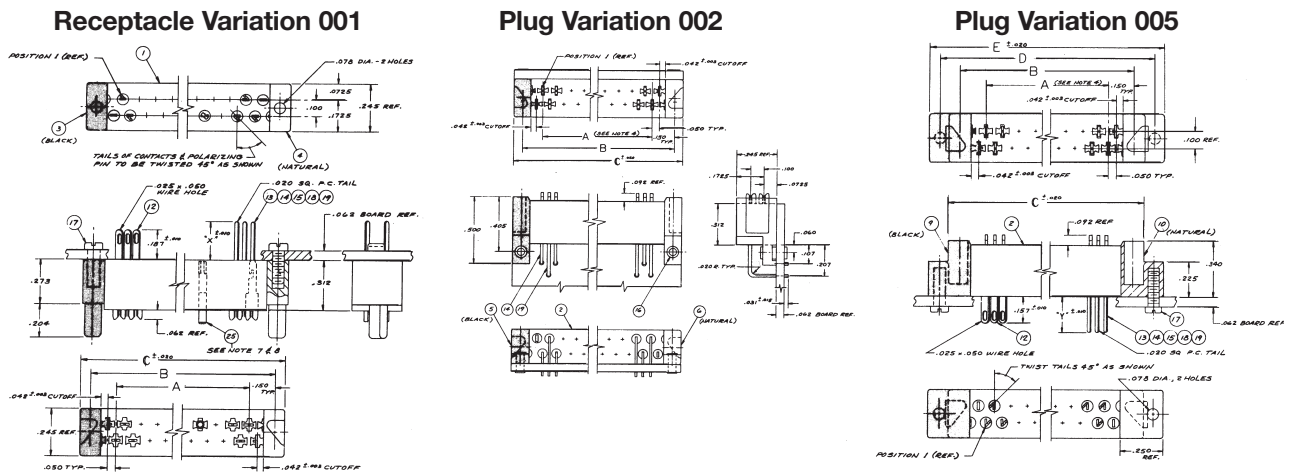

**RECEPTACLE 001 – MATES WITH PLUGS 002 AND 005**

### MOUNTING LAYOUT

Variation 001 and 005

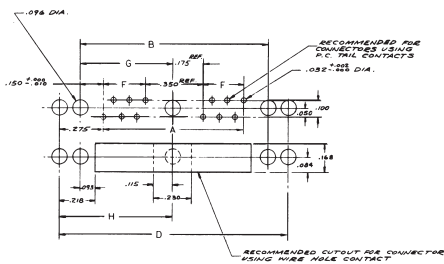

Variation 002

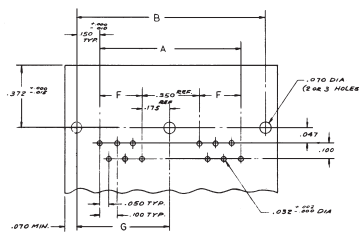

Minimum Center to Center Spacing for Adjustment Plugs

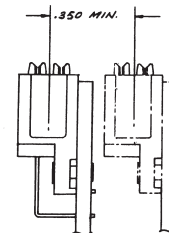

### DIMENSIONS

(inches)

| A                                   | B                      | C                      | D                      | E                      |
|-------------------------------------|------------------------|------------------------|------------------------|------------------------|
| (No. of contacts x 0.050") - 0.050" | "A" dimension + 0.300" | "A" dimension + 0.440" | "A" dimension + 0.550" | "A" dimension + 0.690" |

### POLARIZATION

Keying Ordering No.  
60-8218-4715-00-152



Determine polarization pin location from views.

P = Specify location by contact # where polarizing pin must be inserted.

H = Specify location by contact # where contact must be omitted for mating.

Typical Example: 00-8218-024-721-001-P17 (polarizing pin mtd. in position 17)  
00-8218-024-721-005-H17 (polarizing hole is in position 17)

## Series 8219 – 0.050" Staggered Dual Row

### FEATURES

- For p.c. card-to-card applications
- High contact density
- Low withdrawal force contacts
- Rugged, color coded end guides
- Parallel or perpendicular p.c. board mounting
- Mates with Series 8218

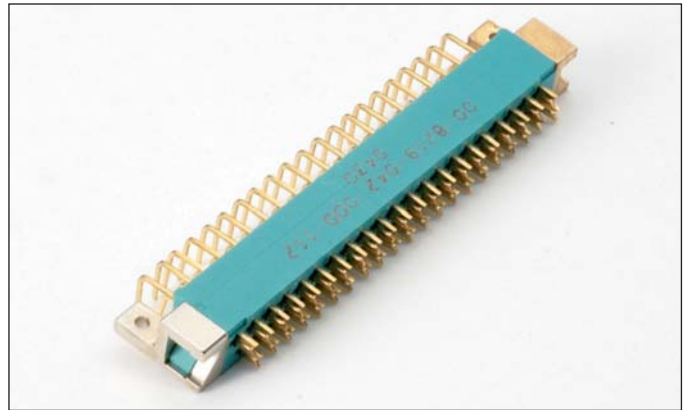

### TECHNICAL SPECIFICATIONS

**Current Rating:**

5 amperes, maximum

**Contact Resistance:**

6 milliohms, maximum

**Contact Material and Plating:**

Phosphor Bronze

Gold, 10 microinches minimum,  
over nickel, 50 to 100 microinches

**Insulator Material:**

Diallyl phthalate, glass-filled, flame resistant per MIL-M-14F, Type SDGF.

**Guidance Hardware:**

Left hand guides: Metal, gold color  
Right hand guides: Metal, silver color

**Insulation Resistance:**

5,000 megohms, minimum

**Dielectric Withstanding Voltage:**

Sea Level: 1000 Volts rms

3.4" Hg: 500 Volts rms

**Insertion/Withdrawal Force:**

2 to 8 ounces per contact

### ORDERING CODE

**00**

**8219**

**042**

**722**

**001**

**Number of Contacts**  
018, 030, 036, 042, 054, 072

**Contact Code**  
(see below)

**Variation Code**

| For Variation = 001 |                   |          | For Variation = 002  |                           |          |              |          |     |                |      |     |                   |      |     |                   |      |     |                   |      |     |                   |      |     |                   |      |
|---------------------|-------------------|----------|--|---------------------------|----------|--------------|----------|-----|----------------|------|-----|-------------------|------|-----|-------------------|------|-----|-------------------|------|-----|-------------------|------|-----|-------------------|------|
| Code No.            | Contact Type      | "X" Dim. | Code No.   | Contact Type              |          |              |          |     |                |      |     |                   |      |     |                   |      |     |                   |      |     |                   |      |     |                   |      |
| 722                 | Wire hole tail    | .187     | 000  | P. C. solder tails formed |          |              |          |     |                |      |     |                   |      |     |                   |      |     |                   |      |     |                   |      |     |                   |      |
| 721                 | P. C. solder tail | .250     | 722  | Wire hole tail unformed   |          |              |          |     |                |      |     |                   |      |     |                   |      |     |                   |      |     |                   |      |     |                   |      |
| 736                 | P. C. solder tail | .281     | <b>For Variation = 005</b> <table border="1"> <thead> <tr> <th>Code No.</th> <th>Contact Type</th> <th>"Y" Dim.</th> </tr> </thead> <tbody> <tr> <td>722</td> <td>Wire hole tail</td> <td>.157</td> </tr> <tr> <td>721</td> <td>P. C. solder tail</td> <td>.219</td> </tr> <tr> <td>736</td> <td>P. C. solder tail</td> <td>.250</td> </tr> <tr> <td>737</td> <td>P. C. solder tail</td> <td>.531</td> </tr> <tr> <td>753</td> <td>P. C. solder tail</td> <td>.093</td> </tr> <tr> <td>771</td> <td>P. C. solder tail</td> <td>.453</td> </tr> </tbody> </table> |                           | Code No. | Contact Type | "Y" Dim. | 722 | Wire hole tail | .157 | 721 | P. C. solder tail | .219 | 736 | P. C. solder tail | .250 | 737 | P. C. solder tail | .531 | 753 | P. C. solder tail | .093 | 771 | P. C. solder tail | .453 |
| Code No.            | Contact Type      | "Y" Dim. |  |                           |          |              |          |     |                |      |     |                   |      |     |                   |      |     |                   |      |     |                   |      |     |                   |      |
| 722                 | Wire hole tail    | .157     |  |                           |          |              |          |     |                |      |     |                   |      |     |                   |      |     |                   |      |     |                   |      |     |                   |      |
| 721                 | P. C. solder tail | .219     |  |                           |          |              |          |     |                |      |     |                   |      |     |                   |      |     |                   |      |     |                   |      |     |                   |      |
| 736                 | P. C. solder tail | .250     |  |                           |          |              |          |     |                |      |     |                   |      |     |                   |      |     |                   |      |     |                   |      |     |                   |      |
| 737                 | P. C. solder tail | .531     |  |                           |          |              |          |     |                |      |     |                   |      |     |                   |      |     |                   |      |     |                   |      |     |                   |      |
| 753                 | P. C. solder tail | .093     |  |                           |          |              |          |     |                |      |     |                   |      |     |                   |      |     |                   |      |     |                   |      |     |                   |      |
| 771                 | P. C. solder tail | .453     |  |                           |          |              |          |     |                |      |     |                   |      |     |                   |      |     |                   |      |     |                   |      |     |                   |      |
| 737                 | P. C. solder tail | .562     |  |                           |          |              |          |     |                |      |     |                   |      |     |                   |      |     |                   |      |     |                   |      |     |                   |      |
| 753                 | P. C. solder tail | .125     |  |                           |          |              |          |     |                |      |     |                   |      |     |                   |      |     |                   |      |     |                   |      |     |                   |      |
| 771                 | P. C. solder tail | .484     |  |                           |          |              |          |     |                |      |     |                   |      |     |                   |      |     |                   |      |     |                   |      |     |                   |      |

| Without Keying |                                    |
|----------------|------------------------------------|
| 001            | Receptacle                         |
| 002            | Plug, parallel board mounting      |
| 005            | Plug, perpendicular board mounting |

**NOTE:** Connector is supplied with mounting screws or eyelets, as applicable (see drawings).

Contact Factory for Special Variations.

### POLARIZING SYSTEM

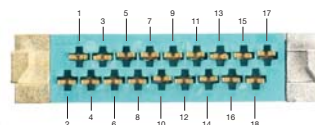

When Keying is ordered with part number, the Key is installed at the factory.

## Series 8219 – 0.050" Staggered Dual Row

### RECEPTACLE - VARIATION 001

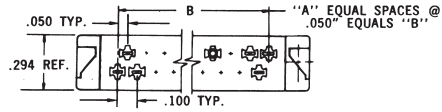
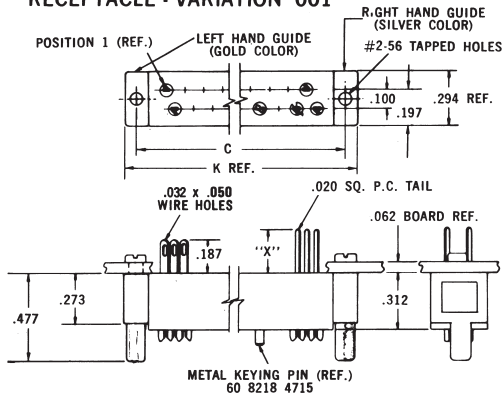

### DIMENSIONS:

millimeters (inches)

| Number of Contacts | A  | B             | C             | Ref. D        | E             | F             | G             | Ref. K        |
|--------------------|----|---------------|---------------|---------------|---------------|---------------|---------------|---------------|
| 18                 | 17 | .850 (0.033)  | 1.150 (0.045) | 1.290 (0.051) | 1.400 (0.055) | 1.540 (0.061) | .964 (0.038)  | 1.300 (0.051) |
| 30                 | 29 | 1.450 (0.057) | 1.750 (0.069) | 1.890 (0.075) | 2.000 (0.079) | 2.140 (0.084) | 1.564 (0.061) | 1.900 (0.075) |
| 36                 | 35 | 1.750 (0.069) | 2.050 (0.080) | 2.190 (0.086) | 2.300 (0.091) | 2.440 (0.096) | 1.864 (0.073) | 2.220 (0.087) |
| 42                 | 41 | 2.050 (0.080) | 2.350 (0.093) | 2.490 (0.098) | 2.600 (0.102) | 2.740 (0.108) | 2.164 (0.085) | 2.500 (0.098) |
| 54                 | 53 | 2.650 (0.104) | 2.950 (0.116) | 3.090 (0.122) | 3.200 (0.126) | 3.340 (0.131) | 2.764 (0.109) | 3.100 (0.122) |
| 72                 | 71 | 3.550 (0.140) | 3.850 (0.152) | 3.990 (0.157) | 4.100 (0.161) | 4.240 (0.167) | 3.664 (0.144) | 4.000 (0.157) |

## RECEPTACLE 001 MATES WITH PLUGS 002 AND 005

### PLUG - VARIATION 002

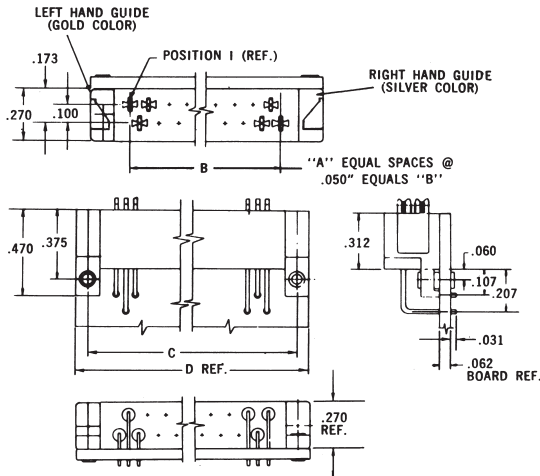

### PLUG - VARIATION 005

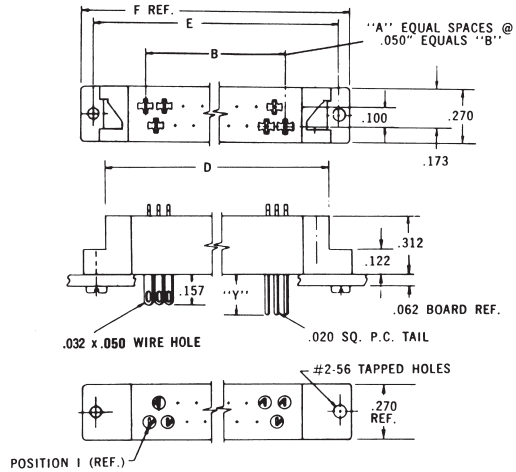

## MOUNTING LAYOUTS

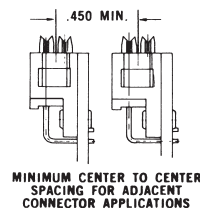
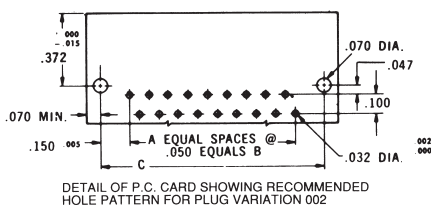
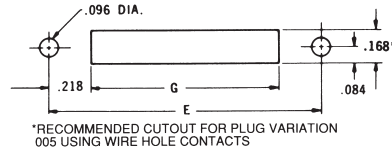
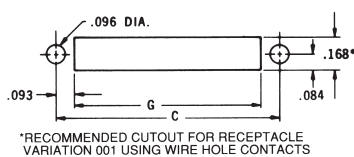
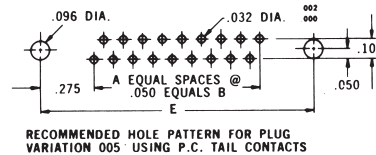
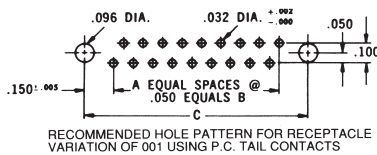

\*When used in metal panel with Code Contact 722 cut out diam. Is .210".

## Series 8223 – 0.100" Dual Row Square Grid

### FEATURES

- Wide range of contact terminations including wire wrapping, P.C. solder tail, wire hole, wire crimp
- For 1/16", 3/32" P.C. card
- Polarity and keying are built into the connector body to prevent mismatching
- Perpendicular or parallel connector mounting
- Proven Varicon® contact reliability
- Protected male; recessed female contacts

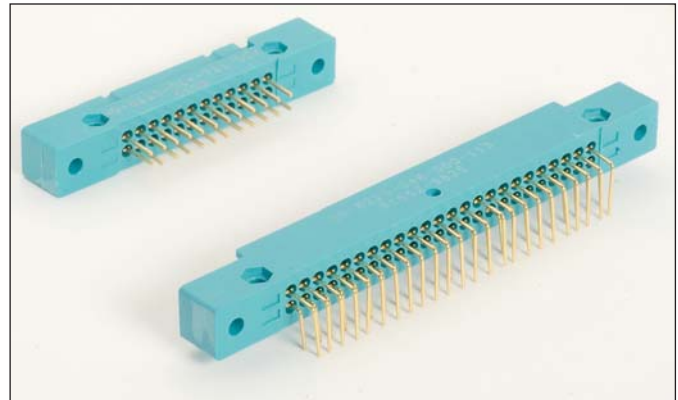

### TECHNICAL SPECIFICATIONS CONTACTS

**Current Rating:**  
5 amperes with 22 AWG wire

**Contact Resistance:**  
6 milliohms, maximum

**Contact Material and Plating:**  
Phosphor Bronze  
Nickel plate, 50 to 100 micro-inches, followed by gold plate.  
10 microinches minimum

### INSULATORS

**Material:**  
Diallyl Phthalate, glass-filled, flame resistant, per MIL-M-14-F, Type SDGF

**Insulation Resistance:**  
5,000 megohms, minimum

**Dielectric Withstanding Voltage:**  
Sea Level: 1,000 Volts rms

**Insertion/Withdrawal Force:**  
2 to 8 ounces per contact

### ORDERING CODE

00

8223

024

000

001

**Number of Contacts**  
024, 048, 072 & 096

**Contact Code**

**Variation Code**

Use three digit code number when contacts are to be factory installed. If contacts are to be supplied loose, or contact tails to be formed, use three zeros (000) in contact code section. Note that the wire crimp tail contacts can only be ordered as separate items by part numbers.

| Code | Profile | Description   | Part No.                     | H Dim. | Board Thk. | Fig. |
|------|---------|---|------------------------------|--------|------------|------|
| 000  |         | Coined Tail Formed 90° after installing (Max. 0236 Diag.) | 60 8223 0223<br>60 8223 0213 | .080   | .062       | 1    |
| 000  |         | Coined Tail Formed 90° after installing (Max. 0236 Diag.) | 60 8223 0243<br>60 8223 0253 | .093   |            | 1    |
| 722  |         | Wire Hole Tail (.032 x .050)                              | 60 8200 1613                 | .162   |            | 3    |
| 721  |         | P.C. Tail .020 Sq.  | 60 8200 1623                 | .228   |            | 4    |
| 736  |         | P.C. Tail .020 Sq.  | 60 8200 1633                 | .259   |            | 4    |
| 737  |         | P.C. Tail .020 Sq.  | 60 8200 1643                 | .541   |            | 4    |
| 753  |         | P.C. Tail .020 Sq.  | 60 8200 1653                 | .103   |            | 4    |
| 771  |         | P.C. Tail .020 Sq.  | 60 8200 1663                 | .462   |            | 4    |
| 000  |         | Crimp Contact (Reel 3000) 22-30 AWG                       | 60 8216 0323                 |        |            | 5    |
| 000  |         | Crimp Contact (Loose) 22-30 AWG                           | 60 8216 0313                 |        |            | 5    |
| 491  |         | Wrappable/Removable Contact (.025 Sq.)                    | 60 8216 0413                 | .560   |            | 6    |

| Insulator Type            | Variation               | Contact Style           | Cover | Bracket | Accessories            |                  |           | Refer To Figure | Board Thickness        |
|---------------------------|-------------------------|-------------------------|-------|---------|------------------------|------------------|-----------|-----------------|------------------------|
|                           |                         |                         |       |         | Guide Pins Sockets (R) |                  |           |                 |                        |
|                           |                         |                         |       |         | Keying                 | Threaded Locking | Lkg. Kyg. |                 |                        |
| Male (Exposed Contacts)   | 001                     | Formed Contact Terminal |       |         | X                      |                  |           | 1               | .080 2.03<br>.062 1.57 |
|                           | 002                     | PC Terminal             |       |         | X                      |                  |           | 2               |                        |
|                           |                         | Wire Hole Terminal      |       |         | X                      |                  |           | 3               |                        |
|                           |                         | PC Straight Terminal    |       |         | X                      |                  |           | 4               |                        |
|                           |                         | Crimp Contact           |       |         | X                      |                  |           | 5               |                        |
| 003                       | Wrappable Removable     |                         |       | X       |                        |                  | 6         |                 |                        |
| Female (Exposed Contacts) | 004                     | Formed Contact Terminal |       |         | X                      |                  |           | 1               | .093 2.36              |
|                           | 901                     | Formed Contact Terminal |       |         | X                      |                  |           | 1               | .080 2.03<br>.062 1.57 |
|                           |                         | PC Terminal             |       |         | X                      |                  |           | 2               |                        |
|                           |                         | Wire Hole Terminal      |       |         | X                      |                  |           | 3               |                        |
|                           |                         | PC Straight Terminal    |       |         | X                      |                  |           | 4               |                        |
| 902                       | Crimp Contact           |                         |       | X       |                        |                  | 5         |                 |                        |
| 903                       | Wrappable Removable     |                         |       | X       |                        |                  | 6         |                 |                        |
| 904                       | Formed Contact Terminal |                         |       | X       |                        |                  | 1         | .093 2.36       |                        |

## Series 8223 – 0.100" Dual Row Square Grid

### MALE INSULATORS

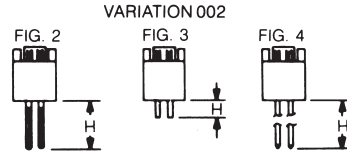
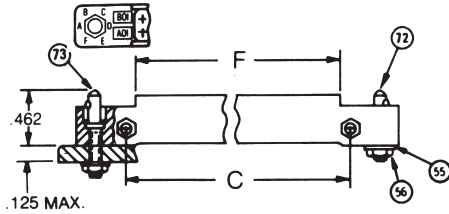
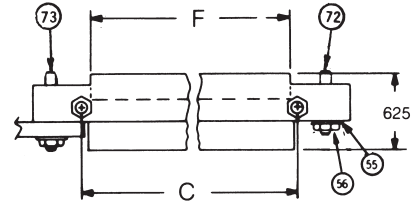
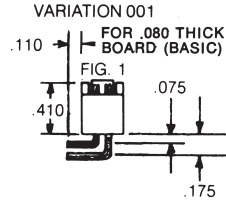
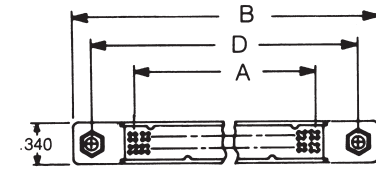

**CRIMP TYPE**

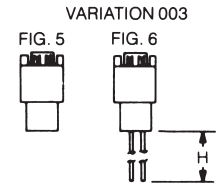

### FEMALE INSULATORS

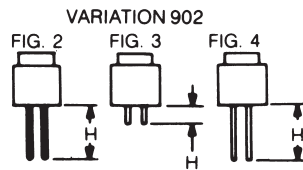
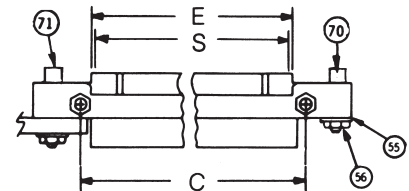
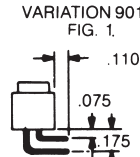
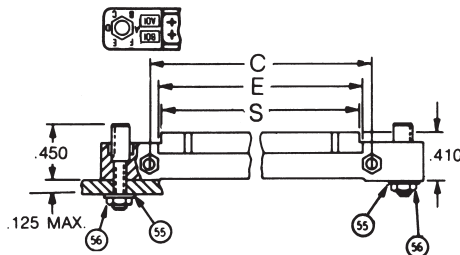

**CRIMP TYPE**

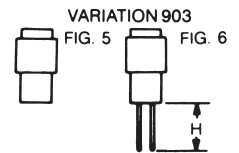

### MOUNTING LAYOUT

Panel for Figures 2, 3, & 4

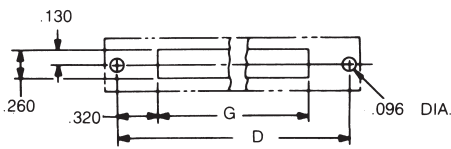

Panel for Figures 5 & 6

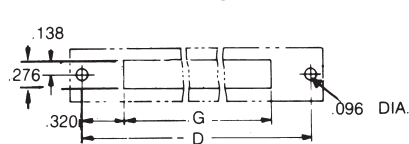

P.C. Board for Figure 1

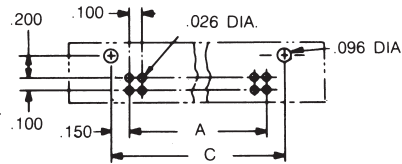

P.C. Board for Figures 2, 3, & 4

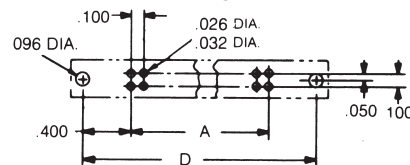

### MOUNTING HARDWARE

(See drawings for correct assembly of hardware. Hardware shown is supplied with each board mounted connector.)

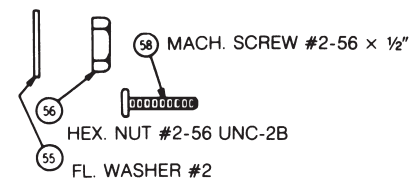

### KEY TO DIAGRAMS

| No. of Contacts | A   | B   | C   | D   | E    | F     | G    | H      | S     |
|-----------------|-----|-----|-----|-----|------|-------|------|--------|-------|
| 24              | 1.1 | 2.2 | 1.4 | 1.9 | 1.27 | 1.252 | 1.26 | Pg. 26 | 1.236 |
| 48              | 2.3 | 3.4 | 2.6 | 3.1 | 2.47 | 2.452 | 2.46 | Pg. 26 | 2.436 |
| 72              | 3.5 | 4.6 | 3.8 | 4.3 | 3.67 | 3.652 | 3.66 | Pg. 26 | 3.636 |
| 96              | 4.7 | 5.8 | 5.0 | 5.5 | 4.87 | 4.852 | 4.86 | Pg. 26 | 4.836 |

| Item | Size | Part # Unified Thread |
|------|------|-----------------------|
| 55   | #2   | 90-0502-0031-11-053   |
| 56   | #2-5 | 90-0602-0121-11-053   |
| 58   | #2-5 | 90-0902-0136-11-053   |

| Item | Size | Part #              |
|------|------|---------------------|
| 70   | #2-5 | 60-8223-4562-11-062 |
| 71   | #2-5 | 60-8223-4522-11-062 |
| 72   | #2-5 | 60-8223-4662-11-062 |
| 73   | #2-5 | 60-8223-4662-11-062 |



## Contact Strip

### FEATURES

- Contacts supplied imbedded in vinyl strips, correctly spaced and ready for insertion and staking into p.c. card
- For 1/16" thick p.c. cards
- Mates with Series 7000 Receptacles

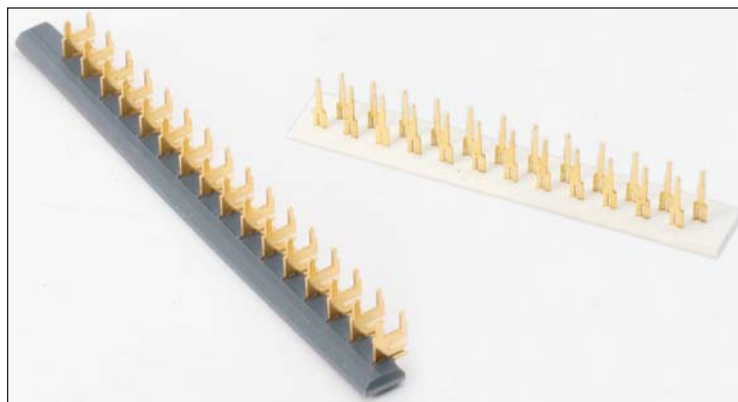

### TECHNICAL SPECIFICATIONS

**Current Rating:**  
10 amperes

**Contact Resistance:**  
6 milliohms, maximum

**Contact Material and Plating:**  
Phosphor Bronze per QQ-B-750, Composition A.

†Gold, 10 microinches minimum, over nickel, 30 to 100 microinches

**Insertion/Withdrawal Force:**  
2 to 16 ounces per contact

### ORDERING CODE

**02**  
Contacts on Plastic Strips

**000**  
Number of Contacts on Strip  
.100 ? = 120 max  
.125 ? = 90 max  
.150 ? = 80 max  
.200 ? = 60 max

**147**  
Type of Contact

**5**  
Contact Pattern  
How the contacts are set on the plastic

**200**  
Contact Spacing  
100 = .100  
125 = .125  
150 = .150  
200 = .200

**000**  
Variation  
Plating  
Marking  
Other

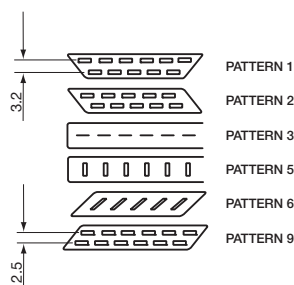

## Contact Strip

| Contact Code | Loose Contact Part Number | For Card Thickness | Silhouette | Available Pattern | Application            | Fig # |
|--------------|---------------------------|--------------------|------------|-------------------|------------------------|-------|
| 013          | 60 5001 1913 00 339       | 1/16" (0.0625)     |            |                   | Module Card Contact    |       |
| 014          | 60 5001 1923 00 339       | 3/32" (0.09375)    |            |                   | Module Card Contact    |       |
| 135          | 60 7001 0413 00 339       | 1/16" (0.0625)     |            |                   | Lower Tier w/Wire Hole |       |
| 137          | 60 7001 0513 00 339       | 1/16" (0.0625)     |            |                   | Upper Tier w/Wire Hole |       |
| 147          | 60 7001 1513 00 339       | 1/16" (0.0625)     |            |                   | Lower Tier             |       |
| 323          | 60 8240 0213 00 339       | 1/16" (0.0625)     |            |                   | Base Card Contact      | 5, 6  |
| 327          | 60 8240 0243 00 339       | 3/32" (0.09375)    |            |                   | Base Card Contact      | 5, 6  |
| 332          | 60 8240 0313 00 339       | 1/16" (0.0625)     |            |                   | Module Card Contact    |       |

# Varicon® Contact Strip Perpendicular Cards – Pad Spacing .200"

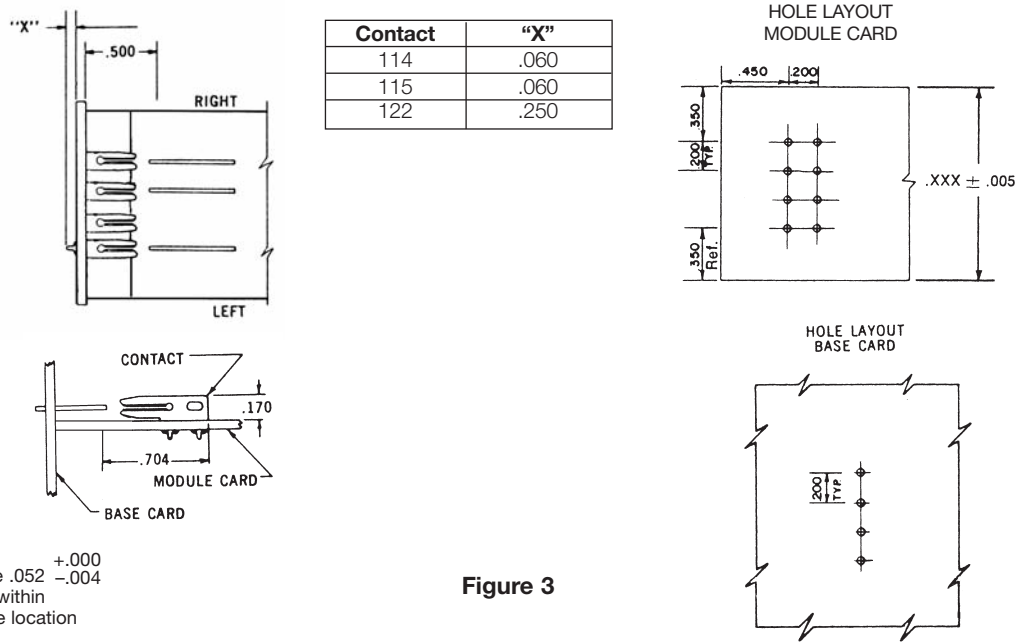

Figure 3

## Tandem Cards – Pad Spacings .125"/.150"/.200"

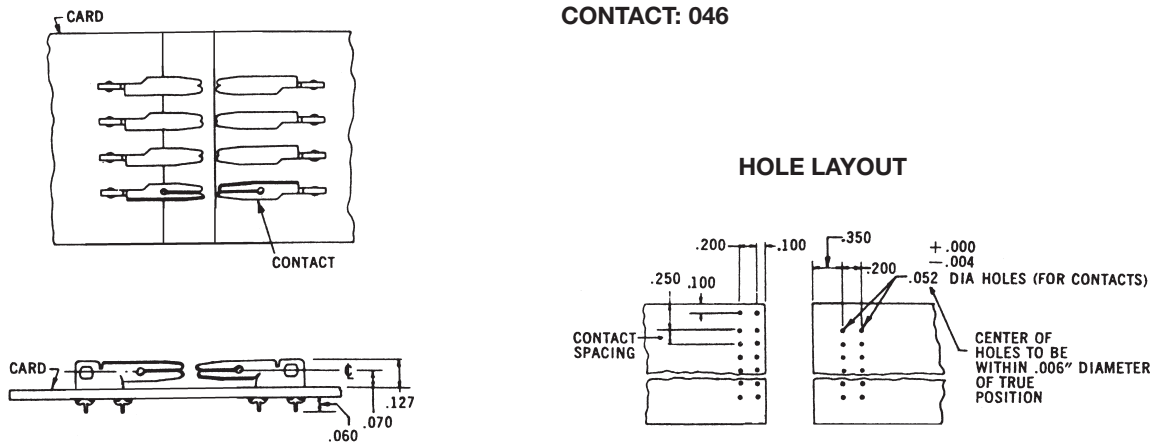

Figure 4

## TECHNICAL SPECIFICATIONS

### Contacts:

Contacts on .125", .150" or .200" Centers  
Contacts supplied on disposable plastic  
carrier strips.

.200" spacing with a max. of 60 contacts.  
.150" spacing with a max. of 80 contacts.  
.125" spacing with a max. of 90 contacts.

### Contact Resistance:

0.006 Ohm, maximum

### Contact Material and Plating:

Phosphor Bronze

Gold, 50 microinches minimum,  
over nickel, 50 to 100 microinches

### Insertion/Withdrawal Force:

2 to 16 ounces per contact

### Current Rating:

8 amperes



# Varicon®

## Contact Strip – Technical

### Parallel Cards – .438" Between Cards

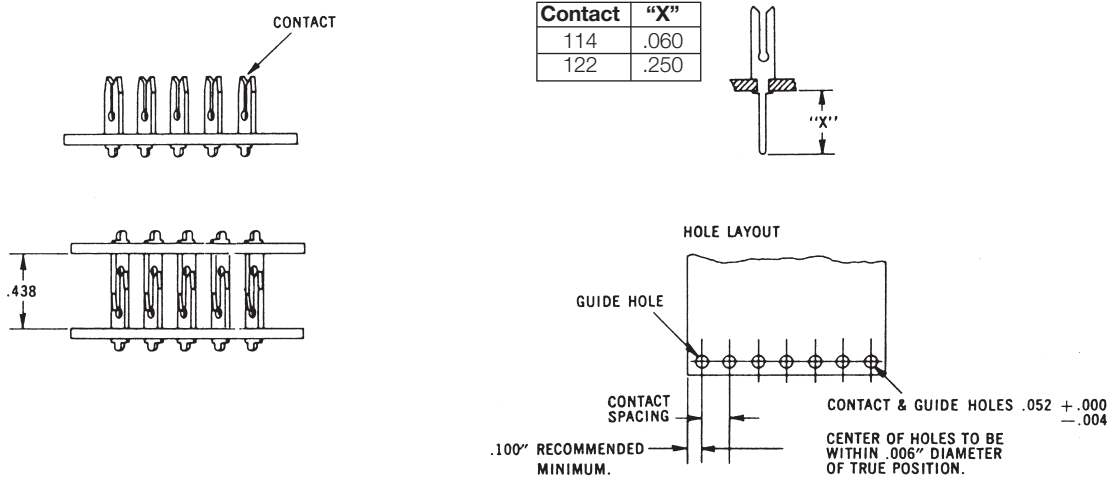

Figure 1

### TECHNICAL SPECIFICATIONS

**Contacts:**

Supplied on disposable plastic carrier strips

**Current Rating:**

8 amperes

**Contact Resistance:**

0.006 Ohm, maximum

**Contact Material and Plating:**

Phosphor Bronze

Gold, 50 microinches minimum, over nickel, 50 to 100 microinches

**Insertion/Withdrawal Force:**

2 to 16 ounces per contact

- Contacts – Contacts are available on four spacings; each spacing has a corresponding maximum number of contacts. Fewer contacts can be ordered.

.200" spacing with a max. of 60 contacts per strip  
 .150" spacing with a max. of 80 contacts per strip  
 .125" spacing with a max. of 90 contacts per strip

### Perpendicular Cards – Pad Spacing .100"

### FEATURES

- For 1/16" and 3/32" thick p.c. cards
- Contacts supplied imbedded in vinyl strips, correctly spaced and ready for insertion and staking into p.c. card
- Complete set of plug contacts supplied on two disposable plastic strips, one for upper-tier contacts, the other for lower-tier contacts
- Efficient and economical installation equipment includes staking and strip removal tools for all applications

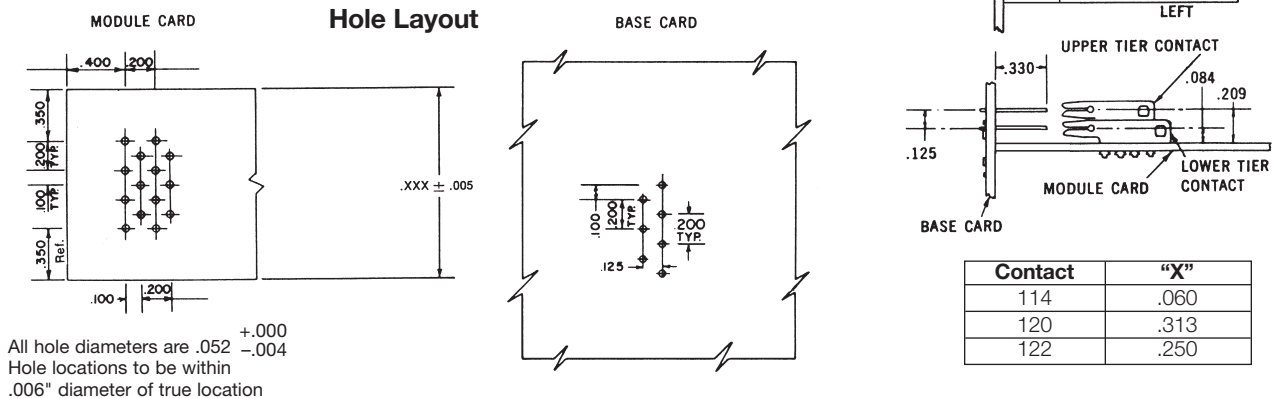
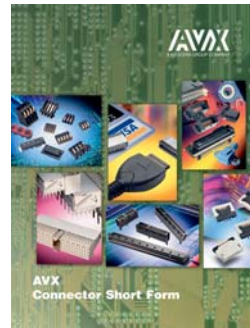

Figure 2



## Connector Short Form



## DIN41612 / EN60603-2 Connectors



## FFC/FPC Connectors



## Memory Card Components

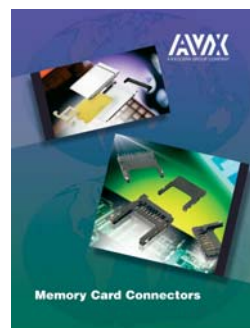



## PASSIVES

### Capacitors

- Multilayer Ceramic
- Tantalum
- Microwave
- Glass
- Film
- Power Film
- Power Ceramic
- Ceramic Disc
- Trimmer
- BestCap™

### Resistors

- Arrays

### Timing Devices

- Resonators
- Oscillators
- Crystals

### Filters

- EMI
- SAW
- Dielectric

### Thin Film

- Inductors
- Fuses
- Capacitors
- Couplers
- Baluns
- Filters

### Integrated Passive Components

- Low Inductance Chip Arrays
- Capacitor Arrays
- Dual Resonance Chips
- Custom IPCs

### Voltage Suppressors, Varistors and Thermistors

### Acoustical Piezos

## CONNECTORS

- 2mm Hard-Metric for CompactPCI®

- Automotive Connectors

- Board to Board Connectors – SMT and Through-Hole

- Card Edge

- Compression

- Custom Designed Connectors

- Customized Backpanel, Racking and Harnessing Services

- DIN 41612 Connectors

- FFC/FPC Connectors

- Insulation Displacement Connectors

- I/O Connectors

- Memory Card Connectors  
CF, PCMCIA, SD, MMC

- MOBO™, I/O, Board to Board and Battery Connectors

- Press-fit Connectors

- Varicon®

- Wire to Board, Crimp or IDC

**For more information please visit  
our website at**

**<http://www.avx.com>**

NOTICE: Specifications are subject to change without notice. Contact your nearest AVX Sales Office for the latest specifications. All statements, information and data given herein are believed to be accurate and reliable, but are presented without guarantee, warranty, or responsibility of any kind, expressed or implied. Statements or suggestions concerning possible use of our products are made without representation or warranty that any such use is free of patent infringement and are not recommendations to infringe any patent. The user should not assume that all safety measures are indicated or that other measures may not be required. Specifications are typical and may not apply to all applications.

© AVX Corporation

## AMERICAS

**AVX Greenville, SC**  
Tel: 864-967-2150

**AVX Northwest, WA**  
Tel: 360-699-8746

**AVX Midwest, IN**  
Tel: 317-861-9184

**AVX Mid/Pacific, CA**  
Tel: 408-988-4900

**AVX Northeast, MA**  
Tel: 617-479-0345

**AVX Southwest, CA**  
Tel: 949-859-9509

**AVX Canada**  
Tel: 905-238-3151

**AVX South America**  
Tel: +55-11-4688-1960

## EUROPE

**AVX Limited, England**  
Tel: +44-1276-697000

**AVX S.A.S., France**  
Tel: +33-1-69-18-46-00

**AVX GmbH, Germany**  
Tel: +49-0811-95949-0

**AVX SRL, Italy**  
Tel: +39-02-614-571

**AVX Czech Republic**  
Tel: +420-57-57-57-521

**AVX/ELCO UK**  
Tel: +44-1638-675000

**ELCO Europe GmbH**  
Tel: +49-2741-299-0

**AVX S.A., Spain**  
Tel: +34-91-63-97-197

**AVX Benelux**  
Tel: +31-187-489-337

## ASIA-PACIFIC

**AVX/Kyocera (S) Pte Ltd.,  
Singapore**  
Tel: +65-6286-7555

**AVX/Kyocera, Asia, Ltd.,  
Hong Kong**  
Tel: +852-2363-3303

**AVX/Kyocera Yuhan Hoesa,  
South Korea**  
Tel: +82-2785-6504

**AVX/Kyocera HK Ltd.,  
Taiwan**  
Tel: +886-2-2656-0258

**AVX/Kyocera (M) Sdn Bhd,  
Malaysia**  
Tel: +60-4228-1190

**AVX/Kyocera International  
Trading Co. Ltd.,  
Shanghai**  
Tel: +86-21-3255 1933

**AVX/Kyocera Asia Ltd.,  
Shenzen**  
Tel: +86-755-3336-0615

**AVX/Kyocera International  
Trading Co. Ltd.,  
Beijing**  
Tel: +86-10-6588-3528

**AVX/Kyocera India  
Liaison Office**  
Tel: +91-80-6450-0715

## ASIA-KED

(KYOCERA Electronic Devices)

**KED Hong Kong Ltd.**  
Tel: +852-2305-1080/1223

**KED Hong Kong Ltd.  
Shenzen**  
Tel: +86-755-3398-9600

**KED Company Ltd.  
Shanghai**  
Tel: +86-21-3255-1833

**KED Hong Kong Ltd.  
Beijing**  
Tel: +86-10-5869-4655

**KED Taiwan Ltd.**  
Tel: +886-2-2950-0268

**KED Korea Yuhan Hoesa,  
South Korea**  
Tel: +82-2-783-3604/6126

**KED (S) Pte Ltd.  
Singapore**  
Tel: +65-6509-0328

**Kyocera Corporation  
Japan**  
Tel: +81-75-604-3449

### Contact:



# Mouser Electronics

Authorized Distributor

Click to View Pricing, Inventory, Delivery & Lifecycle Information:

## AVX:

[008016020000608](#) [008016038000601](#) [008016038000608](#) [008016056000601](#) [008016056000608](#)  
[008016090000607](#) [008016120000608](#) [008016120000001](#) [008016120000007](#) [008016120000008](#) [008016038000001](#)  
[008016038000002](#) [008016038000008](#) [008016020000007](#) [008016020000001](#) [008016090000002](#)  
[008016090000008](#) [008016090000001](#) [008016090000007](#) [008016056000001](#) [608017032300339](#) [608216031300343](#)  
[608017031300339](#) [008223096491101](#) [608218471500152](#) [008026075000715](#) [008219018000112](#)  
[061877040000000](#) [008016020000601](#) [067852010000000](#) [008223024721107](#) [008219018753111](#)  
[008223048722009M](#) [008016056000610](#) [008016056000604](#) [008218054000002](#) [008016120000604](#)  
[008129006610001](#) [608223466200062](#) [008016038000610](#) [608017000000000](#) [308016038000413](#) [020140135200000](#)  
[020243279200100](#) [067698010000000](#) [208014264000100S](#) [608216000000000](#)