

## FEATURES

- 12-bit plus sign SAR ADC
- True bipolar input ranges
- Software-selectable input ranges  
 $\pm 10\text{ V}$ ,  $\pm 5\text{ V}$ ,  $\pm 2.5\text{ V}$ ,  $0\text{ V}$  to  $+10\text{ V}$
- 500 kSPS throughput rate
- 8 analog input channels with channel sequencer
- Single-ended, true differential, and pseudo differential analog input capability
- High analog input impedance
- Low power: 18 mW
- Temperature indicator
- Full power signal bandwidth: 22 MHz
- Internal 2.5 V reference
- High speed serial interface
- Power-down modes
- 20-lead TSSOP package
- iCMOS process technology

## ENHANCED PRODUCT FEATURES

- Supports defense and aerospace applications (AQEC standard)
- Military temperature range:  $-55^{\circ}\text{C}$  to  $+125^{\circ}\text{C}$
- Controlled manufacturing baseline
- One assembly/test site
- One fabrication site
- Product change notification
- Qualification data available on request

## GENERAL DESCRIPTION

The AD7327-EP<sup>1</sup> is an 8-channel, 12-bit plus sign successive approximation ADC designed on the iCMOS<sup>®</sup> (industrial CMOS) process. It enables the development of a wide range of high performance analog ICs capable of 33 V operation in a footprint that no previous generation of high voltage devices achieved. Unlike analog ICs using conventional CMOS processes, iCMOS components can accept bipolar input signals while providing increased performance, dramatically reduced power consumption, and reduced package size.

The AD7327-EP can accept true bipolar analog input signals, software-selectable from  $\pm 10\text{ V}$ ,  $\pm 5\text{ V}$ ,  $\pm 2.5\text{ V}$ , and  $0\text{ V}$  to  $+10\text{ V}$ . Each analog input channel can be independently programmed to one of the four input ranges. The analog input channels on the AD7327-EP can be programmed to be single-ended, true differential, or pseudo differential.

<sup>1</sup> Protected by U.S. Patent No. 6,731,232.

### Rev. C

Information furnished by Analog Devices is believed to be accurate and reliable. However, no responsibility is assumed by Analog Devices for its use, nor for any infringements of patents or other rights of third parties that may result from its use. Specifications subject to change without notice. No license is granted by implication or otherwise under any patent or patent rights of Analog Devices. Trademarks and registered trademarks are the property of their respective owners.

### Document Feedback

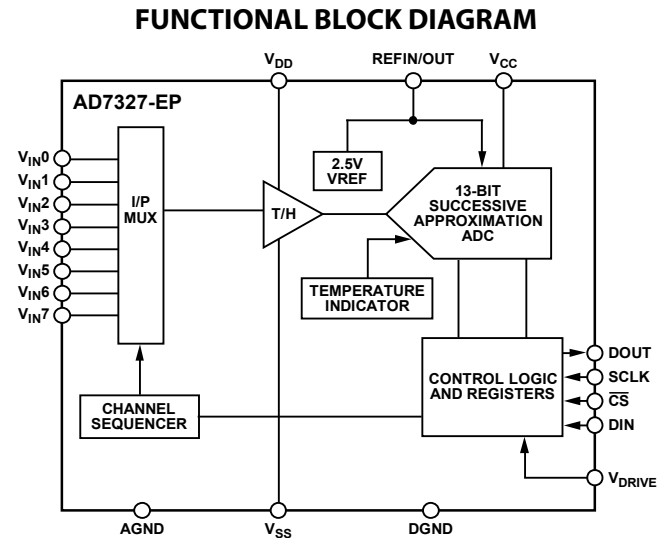

Figure 1.

The ADC contains a 2.5 V internal reference. The AD7327-EP also allows external reference operation. If a 3 V reference is applied to the REF/IN/OUT pin, the AD7327-EP can accept a true bipolar  $\pm 12\text{ V}$  analog input. Minimum  $\pm 12\text{ V}$   $V_{DD}$  and  $V_{SS}$  supplies are required for the  $\pm 12\text{ V}$  input range. The ADC has a high speed serial interface that can operate at throughput rates up to 500 kSPS.

The AD7327-EP is housed in a 20-lead TSSOP with operation specified from  $-55^{\circ}\text{C}$  to  $+125^{\circ}\text{C}$ . Additional application and technical information can be found in the [AD7327](#) data sheet.

## PRODUCT HIGHLIGHTS

1. The AD7327-EP can accept true bipolar analog input signals,  $\pm 10\text{ V}$ ,  $\pm 5\text{ V}$ ,  $\pm 2.5\text{ V}$ , and  $0\text{ V}$  to  $+10\text{ V}$  (unipolar).
2. The eight analog inputs can be configured as eight single-ended inputs, four true differential inputs, four pseudo differential inputs, or seven pseudo differential inputs.
3. 500 kSPS serial interface. SPI<sup>®</sup>-/QSPI<sup>™</sup>-/DSP-/MICROWIRE<sup>™</sup>-compatible interface.
4. Low power, 18 mW, at a maximum throughput rate of 500 kSPS.
5. Channel sequencer.

**TABLE OF CONTENTS**

Features .....	1	Absolute Maximum Ratings .....	8
Enhanced Product Features .....	1	ESD Caution.....	8
General Description .....	1	Pin Configuration and Function Descriptions.....	9
Functional Block Diagram .....	1	Typical Performance Characteristics .....	10
Product Highlights .....	1	Outline Dimensions .....	14
Revision History .....	2	Ordering Guide .....	14
Specifications.....	3		
Timing Specifications .....	7		

**REVISION HISTORY**

<b>4/2018—Rev. B to Rev. C</b>		<b>10/2014—Rev. 0 to Rev. A</b>	
Changes to Features Section.....	1	Changes to Operating Temperature Range, Table 3 .....	8
Changes to Ordering Guide .....	14		
<b>9/2015—Rev. A to Rev. B</b>		<b>9/2014—Revision 0: Initial Version</b>	
Added Enhanced Product Features Section.....	1		

## SPECIFICATIONS

$V_{DD} = 12\text{ V to }16.5\text{ V}$ ,  $V_{SS} = -12\text{ V to }-16.5\text{ V}$ ,  $V_{CC} = 2.7\text{ V to }5.25\text{ V}$ ,  $V_{DRIVE} = 2.7\text{ V to }5.25\text{ V}$ ,  $V_{REF} = 2.5\text{ V to }3.0\text{ V}$  internal/external,  $f_{SCLK} = 10\text{ MHz}$ ,  $f_s = 500\text{ kSPS}$ ,  $T_A = T_{MAX}$  to  $T_{MIN}$ , unless otherwise noted.

Table 1.

Parameter <sup>1</sup>	Min	Typ	Max	Unit	Test Conditions/Comments
<b>DYNAMIC PERFORMANCE</b>					
Signal-to-Noise Ratio (SNR) <sup>2</sup>	76			dB	$f_{IN} = 50\text{ kHz}$ sine wave Differential mode, $V_{CC} = 4.75\text{ V to }5.25\text{ V}$
	75.5			dB	Differential mode, $V_{CC} < 4.75\text{ V}$
	72			dB	Single-ended/pseudo differential mode; $\pm 10\text{ V}$ , $\pm 2.5\text{ V}$ and $\pm 5\text{ V}$ ranges, $V_{CC} = 4.75\text{ V to }5.25\text{ V}$
	71.7			dB	Single-ended/pseudo differential mode; $0\text{ V to }10\text{ V}$ $V_{CC} = 4.75\text{ V to }5.25\text{ V}$ and all ranges at $V_{CC} < 4.75\text{ V}$
Signal-to-Noise + Distortion (SINAD) <sup>2</sup>	75			dB	Differential mode; $\pm 2.5\text{ V}$ and $\pm 5\text{ V}$ ranges
	74			dB	Differential mode; $0\text{ V to }10\text{ V}$
	70.7	76		dB	Differential mode; $\pm 10\text{ V}$ range
			72.5	dB	Single-ended/pseudo differential mode; $\pm 2.5\text{ V}$ and $\pm 5\text{ V}$ ranges
Total Harmonic Distortion (THD) <sup>2</sup>			-79.3	dB	Single-ended/pseudo differential mode; $0\text{ V to }+10\text{ V}$ and $\pm 10\text{ V}$ ranges
			-78.8	dB	Differential mode; $\pm 2.5\text{ V}$ and $\pm 5\text{ V}$ ranges
		-82		dB	Differential mode; $0\text{ V to }10\text{ V}$ ranges
			-76	dB	Differential mode; $\pm 10\text{ V}$ range
			-77.3	dB	Single-ended/pseudo differential mode; $\pm 5\text{ V}$ range
		-80		dB	Single-ended/pseudo differential mode; $\pm 2.5\text{ V}$ range
Peak Harmonic or Spurious Noise (SFDR) <sup>2</sup>			-80	dB	Single-ended/pseudo differential mode; $0\text{ V to }+10\text{ V}$ and $\pm 10\text{ V}$ ranges
			-80	dB	Differential mode; $\pm 2.5\text{ V}$ and $\pm 5\text{ V}$ ranges
		-82		dB	Differential mode; $0\text{ V to }10\text{ V}$ ranges
			-77.2	dB	Differential mode; $\pm 10\text{ V}$ ranges
			-78.9	dB	Single-ended/pseudo differential mode; $\pm 5\text{ V}$ range
		-79		dB	Single-ended/pseudo differential mode; $\pm 2.5\text{ V}$ range
Intermodulation Distortion (IMD) <sup>2</sup>					Single-ended/pseudo differential mode; $0\text{ V to }+10\text{ V}$ and $\pm 10\text{ V}$ ranges $f_A = 50\text{ kHz}$ , $f_B = 30\text{ kHz}$
	Second-Order Terms	-88		dB	
Third-Order Terms	-90			dB	
Aperture Delay <sup>3</sup>		7		ns	
Aperture Jitter <sup>3</sup>		50		ps	
Common-Mode Rejection (CMRR) <sup>2</sup>		-79		dB	Up to $100\text{ kHz}$ ripple frequency; see Figure 17
Channel-to-Channel Isolation <sup>2</sup>		-72		dB	$f_{IN}$ on unselected channels up to $100\text{ kHz}$ ; see Figure 14
Full Power Bandwidth		22		MHz	At $3\text{ dB}$
		5		MHz	At $0.1\text{ dB}$

Parameter <sup>1</sup>	Min	Typ	Max	Unit	Test Conditions/Comments
DC ACCURACY <sup>4</sup>					Single-ended/pseudo differential mode 1 LSB = FSR/4096, unless otherwise noted; differential mode 1 LSB = FSR/8192, unless otherwise noted
Resolution	13			Bits	
No Missing Codes	12-bit plus sign (13 bits)			Bits	Differential mode
	11-bit plus sign (12 bits)			Bits	Single-ended/pseudo differential mode
Integral Nonlinearity <sup>2</sup>			±1.25	LSB	Differential mode; V <sub>CC</sub> = 3 V to 5.25 V, typical for V <sub>CC</sub> = 2.7 V
			±1.2	LSB	Single-ended/pseudo differential mode, V <sub>CC</sub> = 3 V to 5.25 V, typical for V <sub>CC</sub> = 2.7 V
		-0.7/+1.2		LSB	Single-ended/pseudo differential mode (LSB = FSR/8192)
Differential Nonlinearity <sup>2</sup>			-0.99/+1.2	LSB	Differential mode; guaranteed no missing codes to 13 bits
			±0.99	LSB	Single-ended mode; guaranteed no missing codes to 12 bits
		-0.7/+1		LSB	Single-ended/pseudo differential mode (LSB = FSR/8192)
Offset Error <sup>2,5</sup>			-6/+10	LSB	Single-ended/pseudo differential mode
			-7/+11	LSB	Differential mode
Offset Error Match <sup>2,5</sup>			±0.8	LSB	Single-ended/pseudo differential mode
			±0.5	LSB	Differential mode
Gain Error <sup>2,5</sup>			±8	LSB	Single-ended/pseudo differential mode
			±15	LSB	Differential mode
Gain Error Match <sup>2,5</sup>			±0.5	LSB	Single-ended/pseudo differential mode
			±0.5	LSB	Differential mode
Positive Full-Scale Error <sup>2,6</sup>			±4	LSB	Single-ended/pseudo differential mode
			±8	LSB	Differential mode
Positive Full-Scale Error Match <sup>2,6</sup>			±0.5	LSB	Single-ended/pseudo differential mode
			±0.5	LSB	Differential mode
Bipolar Zero Error <sup>2,6</sup>			±9	LSB	Single-ended/pseudo differential mode
			±8	LSB	Differential mode
Bipolar Zero Error Match <sup>2,6</sup>			±0.5	LSB	Single-ended/pseudo differential mode
			±0.5	LSB	Differential mode
Negative Full-Scale Error <sup>2,6</sup>			±4	LSB	Single-ended/pseudo differential mode
			±7	LSB	Differential mode
Negative Full-Scale Error Match <sup>2,6</sup>			±0.5	LSB	Single-ended/pseudo differential mode
			±0.5	LSB	Differential mode
ANALOG INPUT					
Input Voltage Ranges <sup>2</sup> (Programmed via Range Registers)		±10		V	Reference = 2.5 V V <sub>DD</sub> = +10 V min, V <sub>SS</sub> = -10 V min, V <sub>CC</sub> = +2.7 V to +5.25 V
		±5		V	V <sub>DD</sub> = +5 V min, V <sub>SS</sub> = -5 V min, V <sub>CC</sub> = +2.7 V to +5.25 V
		±2.5		V	V <sub>DD</sub> = +5 V min, V <sub>SS</sub> = -5 V min, V <sub>CC</sub> = +2.7 V to +5.25 V
		0 to 10		V	V <sub>DD</sub> = +10 V min, V <sub>SS</sub> = AGND min, V <sub>CC</sub> = +2.7 V to +5.25 V
Pseudo Differential V <sub>IN(-)</sub> Input Range <sup>2</sup>		±3.5		V	V <sub>DD</sub> = +16.5 V, V <sub>SS</sub> = -16.5 V, V <sub>CC</sub> = +5 V Reference = 2.5 V; range = ±10 V
		±6		V	Reference = 2.5 V; range = ±5 V
		±5		V	Reference = 2.5 V; range = ±2.5 V
		+3/-5		V	Reference = 2.5 V; range = 0 V to +10 V

Parameter <sup>1</sup>	Min	Typ	Max	Unit	Test Conditions/Comments
DC Leakage Current		3	±80	nA	$V_{IN} = V_{DD}$ or $V_{SS}$
Input Capacitance <sup>3</sup>		13.5		nA	Per input channel, $V_{IN} = V_{DD}$ or $V_{SS}$
		16.5		pF	When in track, ±10 V range
		21.5		pF	When in track, ±5 V and 0 V to +10 V ranges
		3		pF	When in track, ±2.5 V range
					When in hold, all ranges
REFERENCE INPUT/OUTPUT					
Input Voltage Range	2.5		3	V	
Input DC Leakage Current			±1	μA	
Input Capacitance		10		pF	
Reference Output Voltage		2.5		V	
Reference Output Voltage Error at 25°C			±5	mV	
Reference Output Voltage $T_{MIN}$ to $T_{MAX}$			±10	mV	
Reference Temperature Coefficient			25	ppm/°C	
		3		ppm/°C	
Reference Output Impedance		7		Ω	
LOGIC INPUTS					
Input High Voltage, $V_{INH}$	2.4			V	
Input Low Voltage, $V_{INL}$			0.8	V	$V_{CC} = 4.75$ V to 5.25 V
			0.4	V	$V_{CC} = 2.7$ to 3.6 V
Input Current, $I_{IN}$			±1	μA	$V_{IN} = 0$ V or $V_{DRIVE}$
Input Capacitance, $C_{IN}^3$		10		pF	
LOGIC OUTPUTS					
Output High Voltage, $V_{OH}$	$V_{DRIVE} - 0.2$ V			V	$I_{SOURCE} = 200$ μA
Output Low Voltage, $V_{OL}$			0.4	V	$I_{SINK} = 200$ μA
Floating-State Leakage Current			±1	μA	
Floating-State Output Capacitance <sup>3</sup>		5		pF	
Output Coding		Straight natural binary Twos complement			Coding bit set to 1 in control register Coding bit set to 0 in control register
CONVERSION RATE					
Conversion Time			1.6	μs	16 SCLK cycles with SCLK = 10 MHz
Track-and-Hold Acquisition Time <sup>2,3</sup>			305	ns	Full-scale step input
Throughput Rate			500	kSPS	
POWER REQUIREMENTS					
$V_{DD}^2$	12		16.5	V	Digital inputs = 0 V or $V_{DRIVE}$
$V_{SS}^2$	-12		-16.5	V	
$V_{CC}^2$	2.7		5.25	V	
$V_{DRIVE}$	2.7		5.25	V	
Normal Mode (Static)		0.9		mA	$V_{DD}/V_{SS} = ±16.5$ V, $V_{CC}/V_{DRIVE} = 5.25$ V
Normal Mode (Operational)					$f_{SAMPLE} = 500$ kSPS
$I_{DD}$			195	μA	$V_{DD} = 16.5$ V
$I_{SS}$			215	μA	$V_{SS} = -16.5$ V
$I_{CC}$ and $I_{DRIVE}$			2.3	mA	$V_{CC}/V_{DRIVE} = 5.25$ V
Autostandby Mode (Dynamic)					$f_{SAMPLE} = 250$ kSPS
$I_{DD}$			100	μA	$V_{DD} = 16.5$ V
$I_{SS}$			110	μA	$V_{SS} = -16.5$ V
$I_{CC}$ and $I_{DRIVE}$			0.87	mA	$V_{CC}/V_{DRIVE} = 5.25$ V

Parameter <sup>1</sup>	Min	Typ	Max	Unit	Test Conditions/Comments
Autoshutdown Mode (Static)					SCLK on or off
I <sub>DD</sub>			1	μA	V <sub>DD</sub> = 16.5 V
I <sub>SS</sub>			1	μA	V <sub>SS</sub> = -16.5 V
I <sub>CC</sub> and I <sub>DRIVE</sub>			1	μA	V <sub>CC</sub> /V <sub>DRIVE</sub> = 5.25 V
Full Shutdown Mode					SCLK on or off
I <sub>DD</sub>			1	μA	V <sub>DD</sub> = 16.5 V
I <sub>SS</sub>			1	μA	V <sub>SS</sub> = -16.5 V
I <sub>CC</sub> and I <sub>DRIVE</sub>			1	μA	V <sub>CC</sub> /V <sub>DRIVE</sub> = 5.25 V
POWER DISSIPATION					
Normal Mode (Operational)			19	mW	V <sub>DD</sub> = +16.5 V, V <sub>SS</sub> = -16.5 V, V <sub>CC</sub> = +5.25 V
Full Shutdown Mode			38.25	μW	V <sub>DD</sub> = +16.5 V, V <sub>SS</sub> = -16.5 V, V <sub>CC</sub> = +5.25 V

<sup>1</sup> Temperature range is -55°C to +125°C.

<sup>2</sup> See the terminology section of the [AD7327](#) data sheet.

<sup>3</sup> Sample tested during initial release to ensure compliance.

<sup>4</sup> For dc accuracy specifications, the LSB size for differential mode is FSR/8192. For single-ended mode/pseudo differential mode, the LSB size is FSR/4096, unless otherwise noted.

<sup>5</sup> Unipolar 0 V to 10 V range with straight binary output coding.

<sup>6</sup> Bipolar range with twos complement output coding.

**TIMING SPECIFICATIONS**

$V_{DD} = 12\text{ V to }16.5\text{ V}$ ,  $V_{SS} = -12\text{ V to }-16.5\text{ V}$ ,  $V_{CC} = 2.7\text{ V to }5.25\text{ V}$ ,  $V_{DRIVE} = 2.7\text{ V to }5.25\text{ V}$ ,  $V_{REF} = 2.5\text{ V to }3.0\text{ V}$  internal/external,  $T_A = T_{MAX}$  to  $T_{MIN}$ . Timing specifications apply with a 32 pF load, unless otherwise noted. Sample tested during initial release to ensure compliance. All input signals are specified with  $t_r = t_f = 5\text{ ns}$  (10% to 90% of  $V_{DRIVE}$ ) and timed from a voltage level of 1.6 V.

**Table 2.**

Parameter	Limit at $T_{MIN}, T_{MAX}$		Unit	Description $V_{DRIVE} \leq V_{CC}$
	$V_{CC} < 4.75\text{ V}$	$V_{CC} = 4.75\text{ V to }5.25\text{ V}$		
$f_{SCLK}$	50	50	kHz min	
	10	10	MHz max	
$t_{CONVERT}$	$16 \times t_{SCLK}$	$16 \times t_{SCLK}$	ns max	$t_{SCLK} = 1/f_{SCLK}$
$t_{QUIET}$	75	60	ns min	Minimum time between end of serial read and next falling edge of $\overline{CS}$
$t_1$	12	5	ns min	Minimum $\overline{CS}$ pulse width
$t_2^1$	25	20	ns min	$\overline{CS}$ to SCLK set-up time; bipolar input ranges ( $\pm 10\text{ V}$ , $\pm 5\text{ V}$ , $\pm 2.5\text{ V}$ )
	45	35	ns min	Unipolar input range (0 V to 10 V)
$t_3$	26	14	ns max	Delay from $\overline{CS}$ until DOUT three-state disabled
$t_4$	57	43	ns max	Data access time after SCLK falling edge
$t_5$	$0.4 \times t_{SCLK}$	$0.4 \times t_{SCLK}$	ns min	SCLK low pulse width
$t_6$	$0.4 \times t_{SCLK}$	$0.4 \times t_{SCLK}$	ns min	SCLK high pulse width
$t_7$	13	8	ns min	SCLK to data valid hold time
$t_8$	40	22	ns max	SCLK falling edge to DOUT high impedance
	10	9	ns min	SCLK falling edge to DOUT high impedance
$t_9$	4	4	ns min	DIN set-up time prior to SCLK falling edge
$t_{10}$	2	2	ns min	DIN hold time after SCLK falling edge
$t_{POWER-UP}$	750	750	ns max	Power-up from autostandby
	500	500	$\mu\text{s}$ max	Power-up from full shutdown/autoshtutdown mode, internal reference
	25	25	$\mu\text{s}$ typ	Power-up from full shutdown/autoshtutdown mode, external reference

<sup>1</sup> When using the 0 V to 10 V unipolar range, running at 500 kSPS throughput rate with  $t_2$  at 20 ns, the mark space ratio needs to be limited to 50:50.

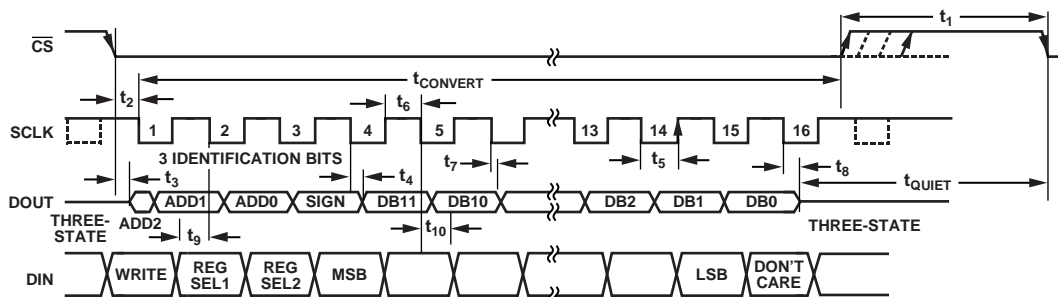

Figure 2. Serial Interface Timing Diagram

12481-002

## ABSOLUTE MAXIMUM RATINGS

$T_A = 25^\circ\text{C}$ , unless otherwise noted.

Table 3.

Parameter	Rating
$V_{DD}$ to AGND, DGND	-0.3 V to +16.5 V
$V_{SS}$ to AGND, DGND	+0.3 V to -16.5 V
$V_{DD}$ to $V_{CC}$	$V_{CC} - 0.3$ V to +16.5 V
$V_{CC}$ to AGND, DGND	-0.3 V to +7 V
$V_{DRIVE}$ to AGND, DGND	-0.3 V to +7 V
AGND to DGND	-0.3 V to +0.3 V
Analog Input Voltage to AGND	$V_{SS} - 0.3$ V to $V_{DD} + 0.3$ V
Digital Input Voltage to DGND	-0.3 V to +7 V
Digital Output Voltage to GND	-0.3 V to $V_{DRIVE} + 0.3$ V
REFIN to AGND	-0.3 V to $V_{CC} + 0.3$ V
Input Current to Any Pin Except Supplies <sup>1</sup>	$\pm 10$ mA
Operating Temperature Range	-55°C to +125°C
Storage Temperature Range	-65°C to +150°C
Junction Temperature	150°C
Thermal Impedance	
$\theta_{JA}$	143°C/W
$\theta_{JC}$	45°C/W
Pb-Free Temperature, Soldering	
Reflow	260(0)°C
ESD	2.5 kV

<sup>1</sup> Transient currents of up to 100 mA do not cause SCR latch-up.

Stresses at or above those listed under Absolute Maximum Ratings may cause permanent damage to the product. This is a stress rating only; functional operation of the product at these or any other conditions above those indicated in the operational section of this specification is not implied. Operation beyond the maximum operating conditions for extended periods may affect product reliability.

### ESD CAUTION



**ESD (electrostatic discharge) sensitive device.** Charged devices and circuit boards can discharge without detection. Although this product features patented or proprietary protection circuitry, damage may occur on devices subjected to high energy ESD. Therefore, proper ESD precautions should be taken to avoid performance degradation or loss of functionality.



## PIN CONFIGURATION AND FUNCTION DESCRIPTIONS

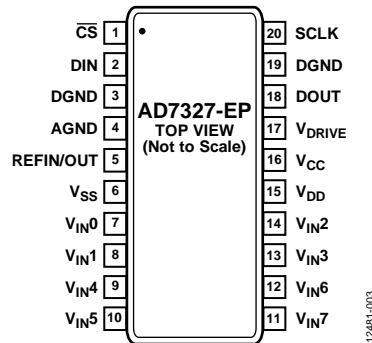

Figure 3. Pin Configuration

Table 4. Pin Function Descriptions

Pin No.	Mnemonic	Description
1	CS	Chip Select. Active low logic input. This input provides the dual function of initiating conversions on the AD7327-EP and frames the serial data transfer.
2	DIN	Data In. Data to be written to the on-chip registers is provided on this input and is clocked into the AD7327-EP on the falling edge of SCLK (see the Registers section of <a href="#">AD7327</a> data sheet).
3, 19	DGND	Digital Ground. Ground reference point for all digital circuitry on the AD7327-EP. The DGND and AGND voltages, ideally, share the same potential and must not be more than 0.3 V apart, even on a transient basis.
4	AGND	Analog Ground. Ground reference point for all analog circuitry on the AD7327-EP. Refer all analog input signals and any external reference signal to this AGND voltage. The AGND and DGND voltages, ideally, share the same potential and must not be more than 0.3 V apart, even on a transient basis.
5	REFIN/OUT	Reference Input/Reference Output. The on-chip reference is available on this pin for external use to the AD7327-EP. The nominal internal reference voltage is 2.5 V, which appears at this pin. Place a 680 nF capacitor on the reference pin (see the Reference section of the <a href="#">AD7327</a> data sheet). Alternatively, the internal reference can be disabled and an external reference applied to this input. On power-up, the external reference mode is the default condition.
6	V <sub>SS</sub>	Negative Power Supply Voltage. V <sub>SS</sub> is the negative supply voltage for the analog input section.
7 to 14	V <sub>IN0</sub> to V <sub>IN7</sub>	Analog Input 0 to Analog Input 7. The analog inputs are multiplexed into the on-chip track-and-hold. The analog input channel for conversion is selected by programming the Channel Address Bit ADD2 through Channel Address Bit ADD0 in the control register. The inputs can be configured as eight single-ended inputs, four true differential input pairs, four pseudo differential inputs, or seven pseudo differential inputs. The configuration of the analog inputs is selected by programming the mode bits, Bit Mode 1 and Bit Mode 0, in the control register. The input range on each input channel is controlled by programming the range registers. Input ranges of ±10 V, ±5 V, ±2.5 V, and 0 V to +10 V can be selected on each analog input channel when a +2.5 V reference voltage is used (see the Registers section of <a href="#">AD7327</a> data sheet).
15	V <sub>DD</sub>	Positive Power Supply Voltage. V <sub>DD</sub> is the positive supply voltage for the analog input section.
16	V <sub>CC</sub>	Analog Supply Voltage, 2.7 V to 5.25 V. V <sub>CC</sub> is the supply voltage for the ADC core on the AD7327-EP. Decouple this supply to AGND.
17	V <sub>DRIVE</sub>	Logic Power Supply Input. The voltage supplied at this pin determines at what voltage the interface operates. Decouple this pin to DGND. The voltage at this pin may be different to that at V <sub>CC</sub> , but V <sub>DRIVE</sub> must not exceed V <sub>CC</sub> by more than 0.3 V.
18	DOUT	Serial Data Output. The conversion output data is supplied to this pin as a serial data stream. The bits are clocked out on the falling edge of the SCLK input, and 16 SCLKs are required to access the data. The data stream consists of three channel identification bits, the sign bit, and 12 bits of conversion data. The data is provided MSB first (see the Serial Interface section of <a href="#">AD7327</a> data sheet).
20	SCLK	Serial Clock, Logic Input. A serial clock input provides the SCLK used for accessing the data from the AD7327-EP. This clock is also used as the clock source for the conversion process.

# TYPICAL PERFORMANCE CHARACTERISTICS

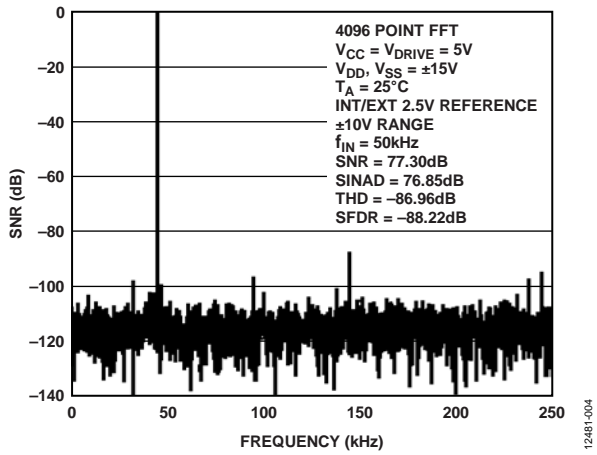

Figure 4. FFT True Differential Mode

12481-004

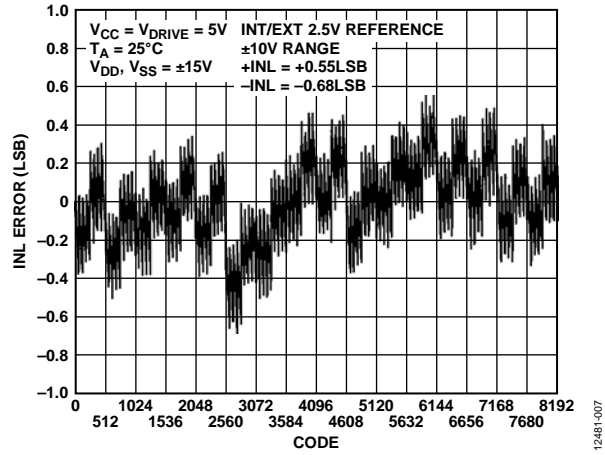

Figure 7. Typical INL True Differential Mode

12481-007

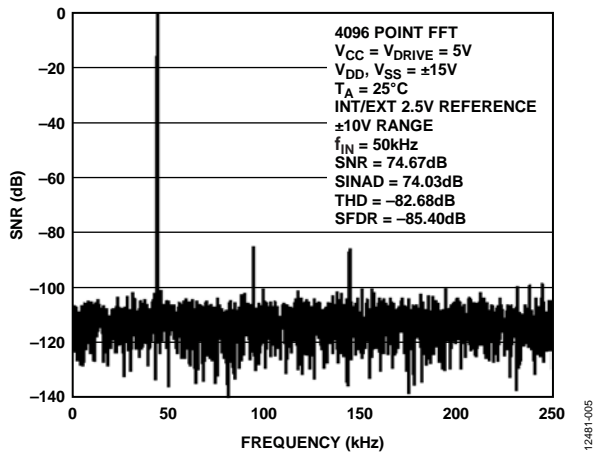

Figure 5. FFT Single-Ended Mode

12481-005

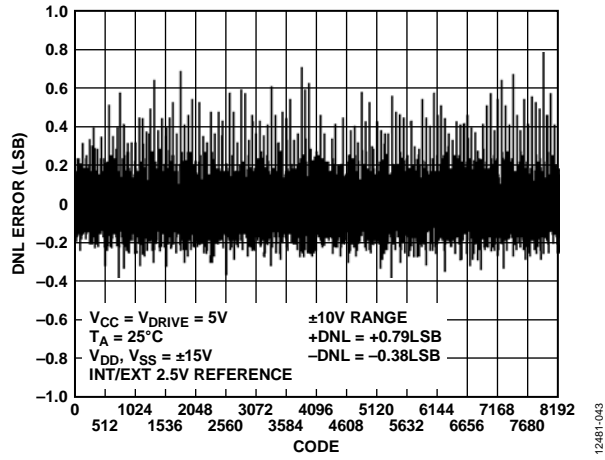

Figure 8. Typical DNL Single-Ended Mode

12481-003

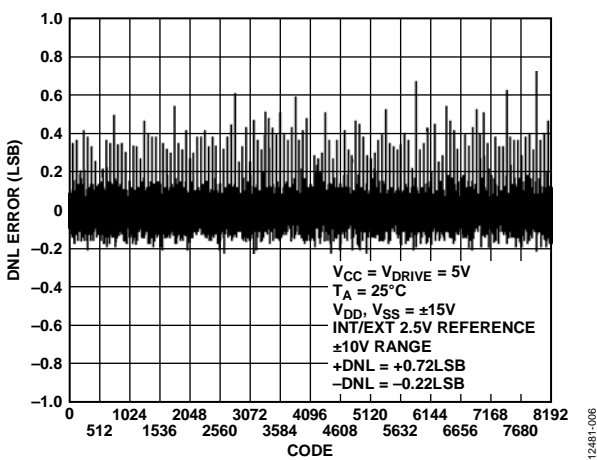

Figure 6. Typical DNL True Differential Mode

12481-006

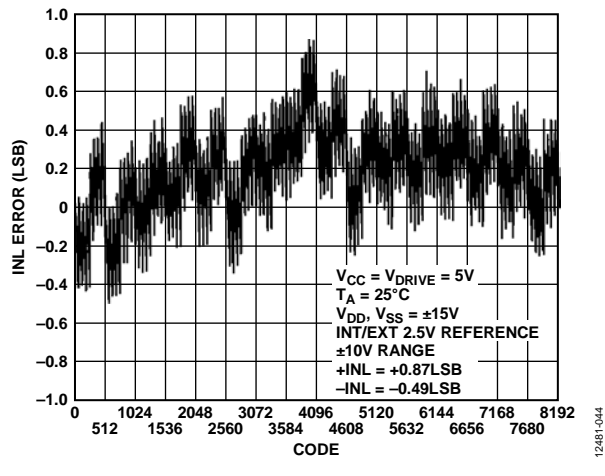

Figure 9. Typical INL Single-Ended Mode

12481-004

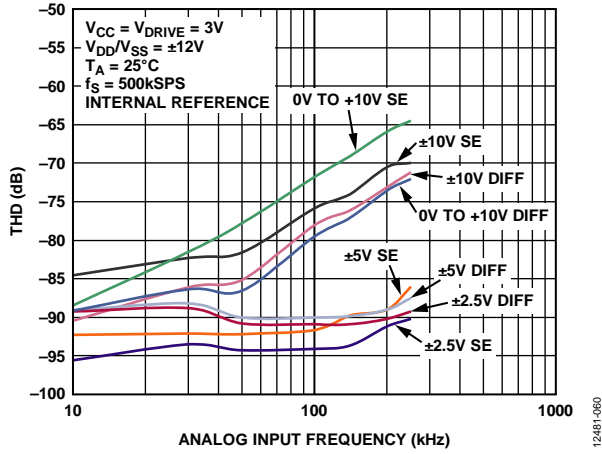

Figure 10. THD vs. Analog Input Frequency for Single-Ended (SE) and True Differential (Diff) Mode at 3 V<sub>CC</sub>

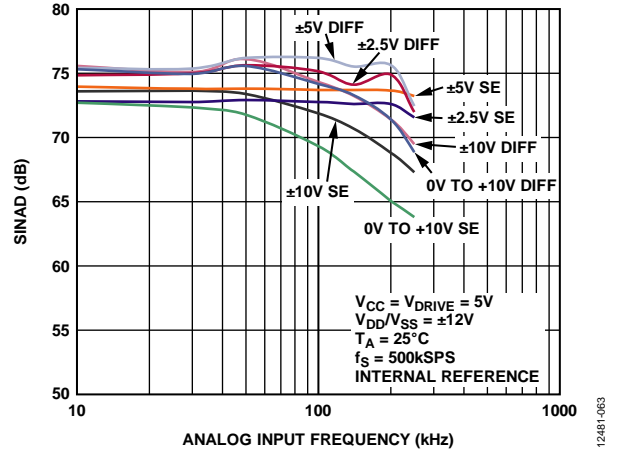

Figure 13. SINAD vs. Analog Input Frequency for Single-Ended (SE) and True Differential (Diff) Mode at 5 V<sub>CC</sub>

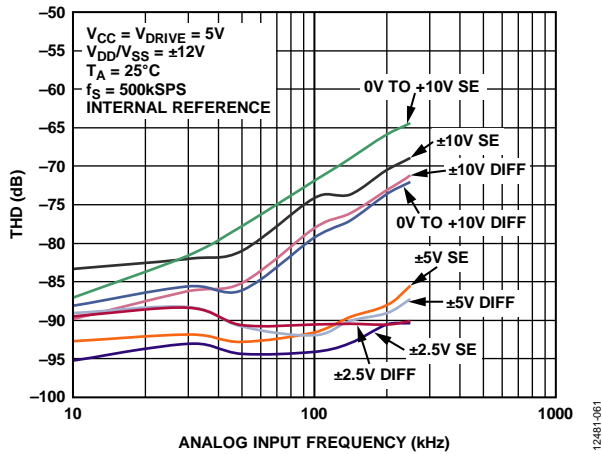

Figure 11. THD vs. Analog Input Frequency for Single-Ended (SE) and True Differential (Diff) Mode at 5 V<sub>CC</sub>

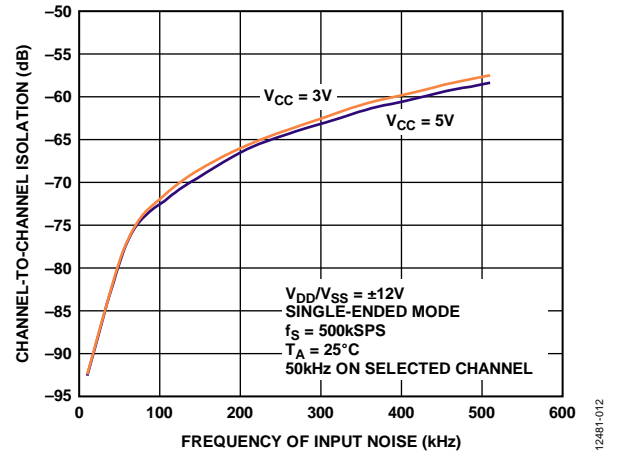

Figure 14. Channel-to-Channel Isolation

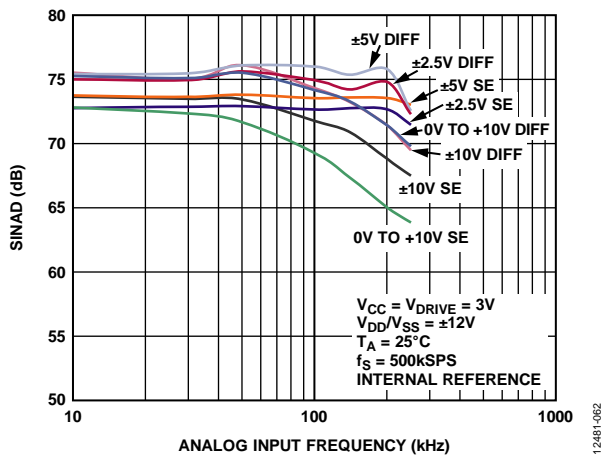

Figure 12. SINAD vs. Analog Input Frequency for Single-Ended (SE) and True Differential (Diff) Mode at 3 V<sub>CC</sub>

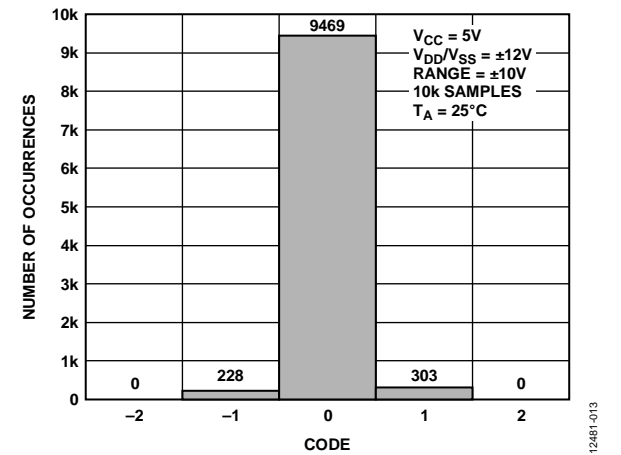

Figure 15. Histogram of Codes, True Differential Mode

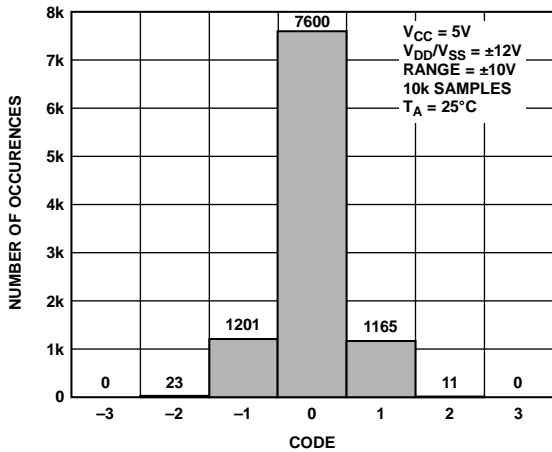

Figure 16. Histogram of Codes, Single-Ended Mode

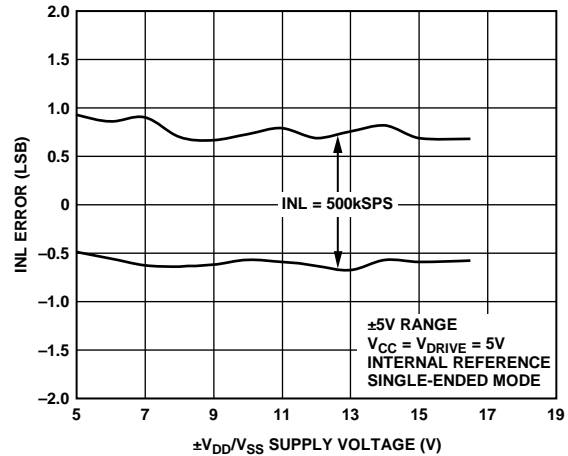

Figure 19. INL Error vs.  $\pm V_{DD}/V_{SS}$  Supply Voltage at 500 kSPS

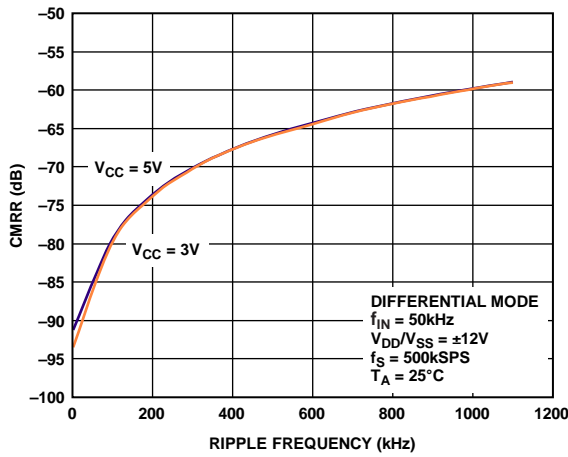

Figure 17. CMRR vs. Common-Mode Ripple Frequency

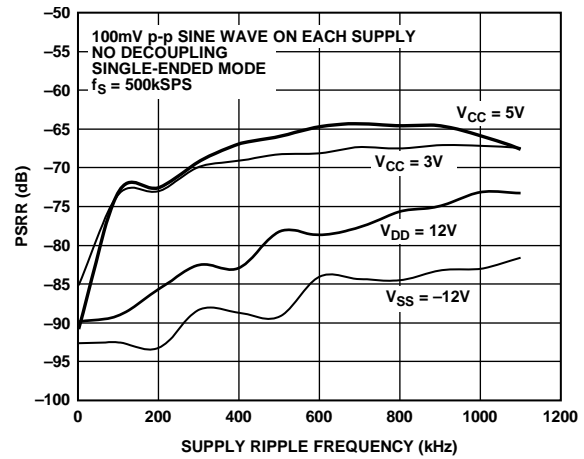

Figure 20. PSRR vs. Supply Ripple Frequency Without Supply Decoupling

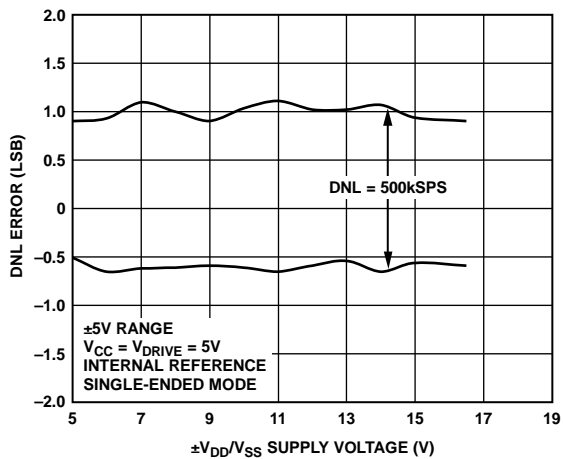

Figure 18. DNL Error vs.  $\pm V_{DD}/V_{SS}$  Supply Voltage at 500 kSPS

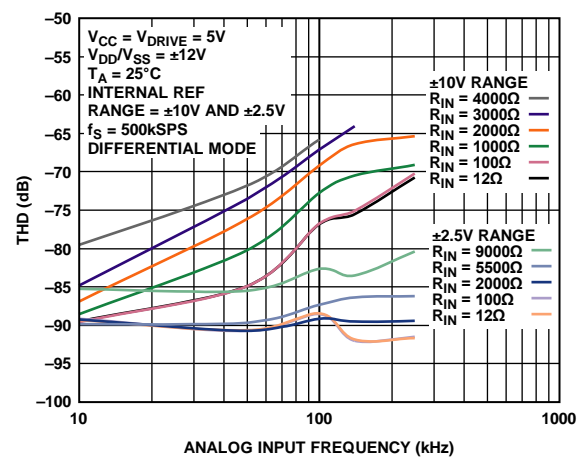

Figure 21. THD vs. Analog Input Frequency for Various Source Impedances, True Differential Mode

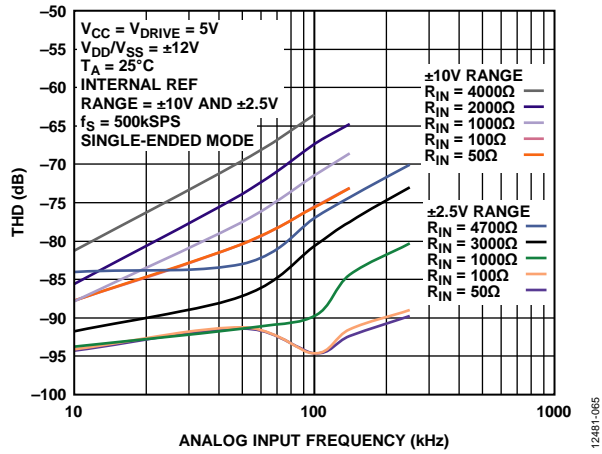
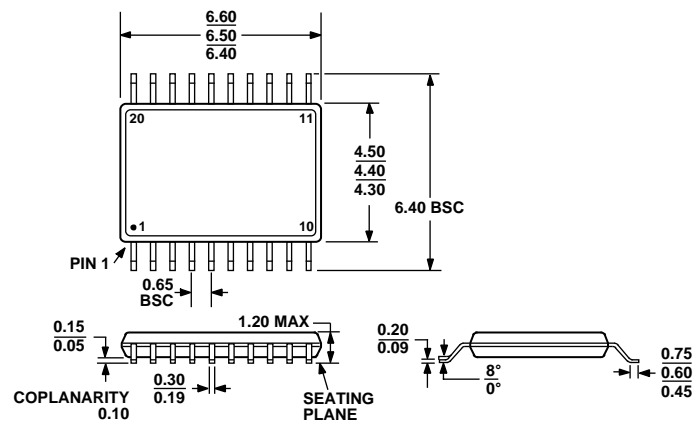

Figure 22. THD vs. Analog Input Frequency for Various Source Impedances, Single-Ended Mode

## OUTLINE DIMENSIONS



COMPLIANT TO JEDEC STANDARDS MO-153-AC

Figure 23. 20-Lead Thin Shrink Small Outline Package [TSSOP]  
(RU-20)

Dimensions show in millimeters

## ORDERING GUIDE

Model <sup>1</sup>	Temperature Range	Package Description	Package Option
AD7327TRU-EP	-55°C to +125°C	20-Lead Thin Shrink Small Outline Package [TSSOP]	RU-20
AD7327TRU-EP-RL7	-55°C to +125°C	20-Lead Thin Shrink Small Outline Package [TSSOP]	RU-20
AD7327TRUZ-EP	-55°C to +125°C	20-Lead Thin Shrink Small Outline Package [TSSOP]	RU-20
AD7327TRUZ-EP-RL7	-55°C to +125°C	20-Lead Thin Shrink Small Outline Package [TSSOP]	RU-20

<sup>1</sup> Z = RoHS Compliant Part.

# Mouser Electronics

Authorized Distributor

Click to View Pricing, Inventory, Delivery & Lifecycle Information:

[Analog Devices Inc.:](#)

[EVAL-AD7327SDZ](#) [AD7327TRU-EP](#) [AD7327TRU-EP-RL7](#) [AD7327TRUZ-EP-RL7](#) [AD7327TRUZ-EP](#)