

General Specifications

Toggles

Rockers

Pushbuttons

Illuminated PB

Programmable

Keylocks

Rotaries

Slides

Tactiles

Tilt

Touch

Indicators

Accessories

Supplement

Electrical Capacity (Resistive Load)

Logic Level: 0.4VA maximum @ 28V AC/DC maximum
(Applicable Range 0.1mA ~ 0.1A @ 20mV ~ 28V)
Note: See Supplement Index to find explanation of operating range.

Other Ratings

Contact Resistance: 80 milliohms maximum
Insulation Resistance: 100 megohms minimum @ 500V DC
Dielectric Strength: 500V AC minimum for 1 minute minimum
Mechanical Life: 30,000 operations minimum
Electrical Life: 10,000 operations minimum
Operating Torque: 0.04Nm average
Contact Timing: Nonshorting (break-before-make)
Indexing: 45° for On-On-On & 90° for On-None-On

Materials & Finishes

Shaft: Brass with nickel plating
Bushing: Zinc alloy with nickel plating
Frame/Bracket: Steel with tin plating
Movable Contacts: Beryllium copper spring with gold plating
Stationary Contacts: Copper with gold plating
Terminals: Brass with tin plating
Base: Polyamide

Environmental Data

Operating Temperature Range: -10°C through +70°C (+14°F through +158°F)
Humidity: 90 ~ 95% humidity for 96 hours @ 40°C (104°F)
Vibration: 10 ~ 55Hz with peak-to-peak amplitude of 1.5mm traversing the frequency range & returning in 1 minute; 3 right angled directions for 2 hours
Shock: 50G (490m/s²) acceleration (tested in 3 right angled directions, with 5 shocks in each direction)
Sealing: Use of optional o-ring AT535 with MRB meets IP67 of IEC60529 specifications

Installation

Mounting Torque: .686Nm (6.08 lb•in)
Cap Installation Force: 19.6 ~ 29.4N (4.41 ~ 6.61 lbf)

PCB Processing

Soldering: Wave Soldering Recommended: See Profile B in Supplement section
Manual Soldering: See Profile B in Supplement section
Cleaning: Automated cleaning. See Cleaning specifications in Supplement section.

Standards & Certifications

The MRB Series rotaries have not been tested for UL recognition or CSA certification. These switches are designed for use in a low-voltage, low-current, logic-level circuit. When used as intended in a logic-level circuit, the results do not produce hazardous energy.

Distinctive Characteristics

Double flatted bushing prevents rotation in panel and increases stability.

Totally sealed construction, achieved with combination of an interior o-ring, a seal between the frame and base, plus insert molded terminals, prevents contact contamination and allows automated soldering and cleaning.

Positive detent mechanism for distinct feel and audible feedback.

Break-before-make contact timing with sliding contact mechanism.

Metal bushing and frame/bracket provide durability.

Panel seal, achieved with use of optional exterior o-ring, conforms to IP67 of IEC60529 Standards.

High contact reliability achieved by the self-cleaning contact mechanism.

.100" x .100" (2.54mm x 2.54mm) terminal spacing conforms to standard PC board grid spacing for straight and right angle mounting.

Insert molded terminals lock out flux and other contaminants.

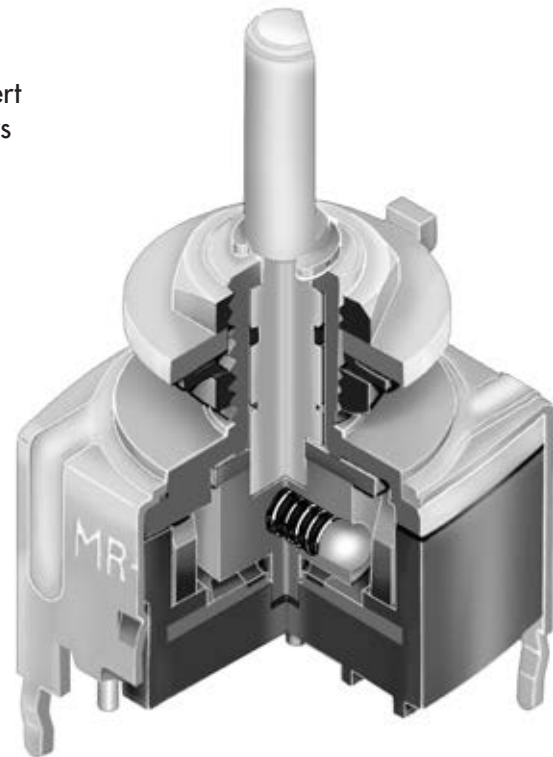

Actual Size

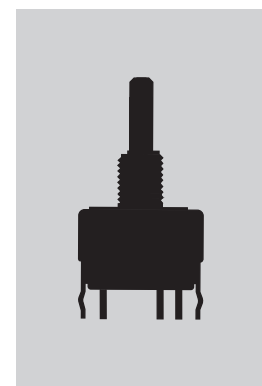

- Toggles
- Rockers
- Pushbuttons
- Illuminated PB
- Programmable
- Keylocks
- Rotaries**
- Slides
- Tactiles
- Tilt
- Touch
- Indicators
- Accessories
- Supplement

TYPICAL SWITCH ORDERING EXAMPLE

MRB **1** **2** **B** — **A**

Poles	
1	SPDT SP3T
2	DPDT DP3T

Terminals	
B	Straight with Bracket
H	Right Angle with Bracket

Knobs	
A	Plain Black
B	Small Color Tipped
C	Large Color Tipped

Colors	
For Plain Knob	
No Code	Black
For Color Tipped	
A	Black
B	White
C	Red
E	Yellow
F	Green
G	Blue
H	Gray

Circuits & Indexing				
2	ON	NONE	ON	90°
4	ON	ON	ON	45°

DESCRIPTION FOR TYPICAL ORDERING EXAMPLE

MRB12B-A

POLES & CIRCUITS

Pole	Model	Actuator Positions			Connected Terminals			Throw & Schematics
		Position 1	Position 2	Position 3	Position 1	Position 2	Position 3	Note: Terminal numbers are not actually on switch
SP	MRB12	ON	NONE	ON	C1-1	OPEN	C1-2	SPDT
	MRB14	ON	ON	ON	C1-1	C1-2	C1-3	SP3T
DP	MRB22	ON	NONE	ON	C1-1 C2-4	OPEN	C1-2 C2-5	DPDT
	MRB24	ON	ON	ON	C1-1 C2-4	C1-2 C2-5	C1-3 C2-6	DP3T

TERMINALS

B Straight PC Terminals with Bracket

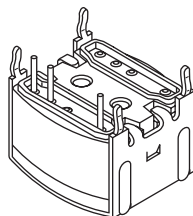

SPDT

H Right Angle PC Terminals with Bracket

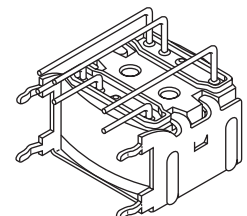

DPDT

TYPICAL SWITCH DIMENSIONS

90° Indexing • SPDT & DPDT • Straight PC

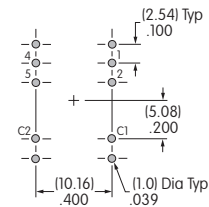
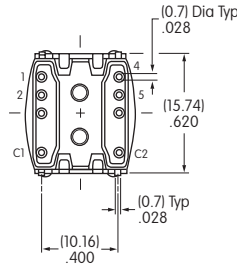
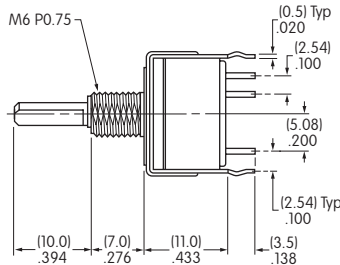
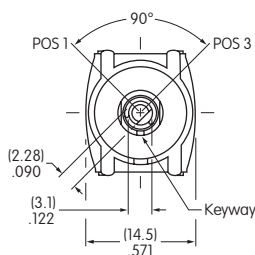

Actuator shown in Position 1

Single pole model does not have terminals 4, 5 & C2

MRB12B

90° Indexing • SPDT • Right Angle PC

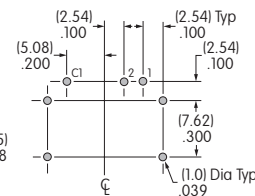
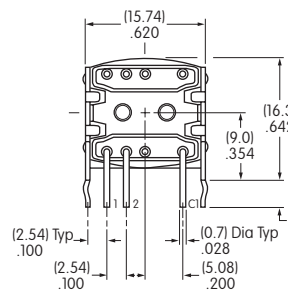
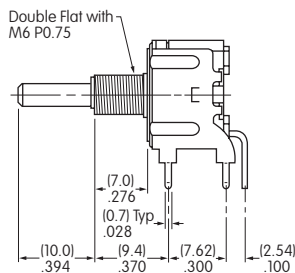
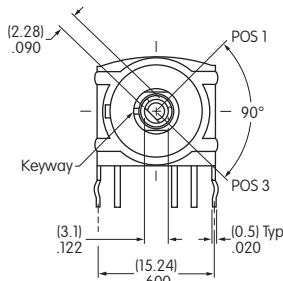

Actuator shown in Position 1

MRB12H

90° Indexing • DPDT • Right Angle PC

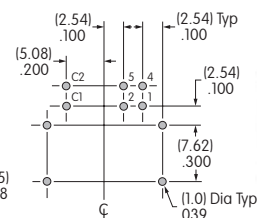
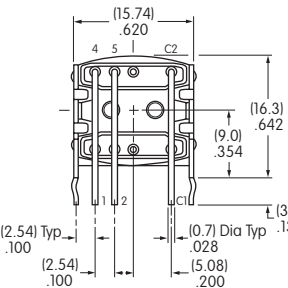
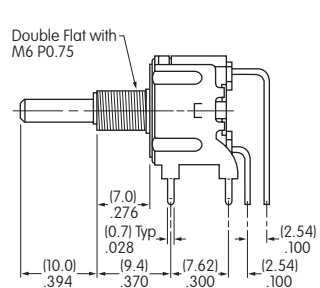
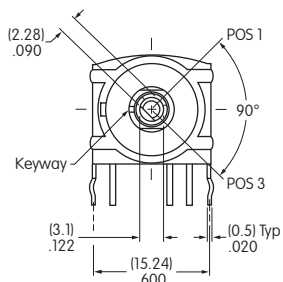

Actuator shown in Position 1

MRB22H

45° Indexing • SP3T & DP3T • Straight PC

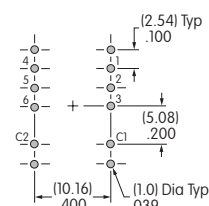
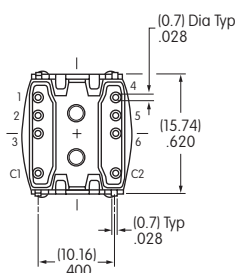
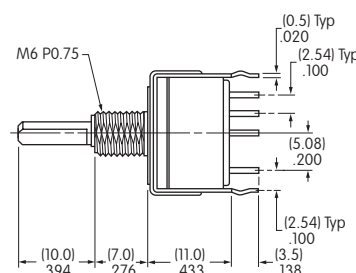
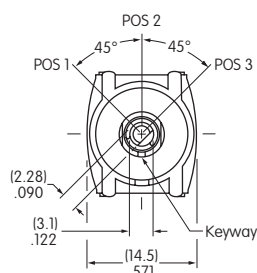

Actuator shown in Position 1

Single pole model does not have terminals 4, 5, 6 & C2

MRB14B

