

CMPD914

**SURFACE MOUNT SILICON  
HIGH SPEED  
SWITCHING DIODE**



**SOT-23 CASE**



[www.centrasemi.com](http://www.centrasemi.com)

**DESCRIPTION:**

The CENTRAL SEMICONDUCTOR CMPD914 is a ultra-high speed silicon switching diode manufactured by the epitaxial planar process, in an epoxy molded surface mount package, designed for high speed switching applications.

**MARKING CODE: C5D**

**MAXIMUM RATINGS:** ( $T_A=25^{\circ}\text{C}$ )

Continuous Reverse Voltage  
Peak Repetitive Reverse Voltage  
Continuous Forward Current  
Peak Repetitive Forward Current  
Peak Forward Surge Current,  $t_p=1.0\mu\text{s}$   
Peak Forward Surge Current,  $t_p=1.0\text{ms}$   
Peak Forward Surge Current,  $t_p=1.0\text{s}$   
Power Dissipation  
Operating and Storage Junction Temperature  
Thermal Resistance

**SYMBOL**

$V_R$  75  
 $V_{RRM}$  100  
 $I_F$  250  
 $I_{FRM}$  250  
 $I_{FSM}$  4.0  
 $I_{FSM}$  2.0  
 $I_{FSM}$  1.0  
 $P_D$  350  
 $T_J, T_{stg}$  -65 to +150  
 $\theta_{JA}$  357

**UNITS**

V  
V  
mA  
mA  
A  
A  
A  
mW  
 $^{\circ}\text{C}$   
 $^{\circ}\text{C/W}$

**ELECTRICAL CHARACTERISTICS:** ( $T_A=25^{\circ}\text{C}$  unless otherwise noted)

SYMBOL	TEST CONDITIONS	MIN	MAX	UNITS
$I_R$	$V_R=20\text{V}$		25	nA
$I_R$	$V_R=75\text{V}$		5.0	$\mu\text{A}$
$BV_R$	$I_R=100\mu\text{A}$	100		V
$V_F$	$I_F=10\text{mA}$		1.0	V
$C_J$	$V_R=0, f=1.0\text{MHz}$		4.0	pF
$t_{rr}$	$I_R=I_F=10\text{mA}, I_{rr}=1.0\text{mA}, R_L=100\Omega$		4.0	ns

CMPD914  
**SURFACE MOUNT SILICON  
HIGH SPEED  
SWITCHING DIODE**



**SOT-23 CASE - MECHANICAL OUTLINE**

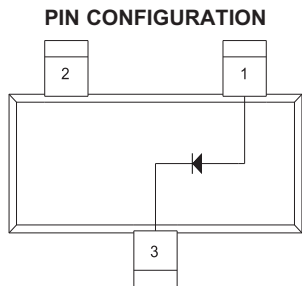
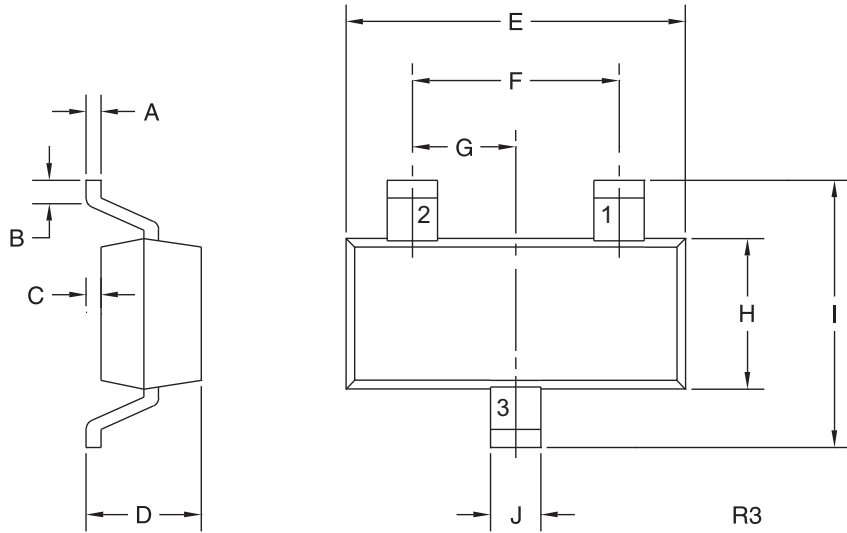

**LEAD CODE:**  
1) Anode  
2) No Connection  
3) Cathode

**MARKING CODE: C5D**

SYMBOL	INCHES		MILLIMETERS	
	MIN	MAX	MIN	MAX
A	0.003	0.007	0.08	0.18
B	0.006	-	0.15	-
C	-	0.005	-	0.13
D	0.035	0.043	0.89	1.09
E	0.110	0.120	2.80	3.05
F	0.075		1.90	
G	0.037		0.95	
H	0.047	0.055	1.19	1.40
I	0.083	0.098	2.10	2.49
J	0.014	0.020	0.35	0.50

SOT-23 (REV: R3)

R7 (12-January 2016)

CMPD914

SURFACE MOUNT SILICON  
HIGH SPEED  
SWITCHING DIODE



TYPICAL ELECTRICAL CHARACTERISTICS

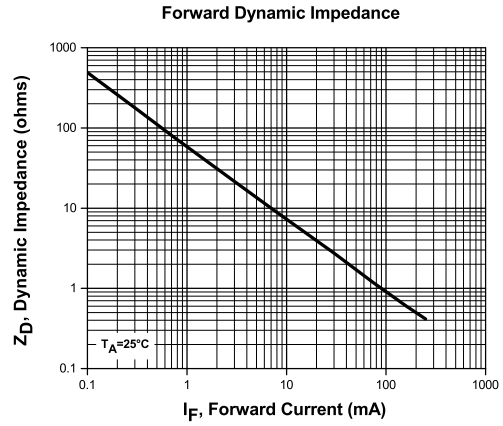
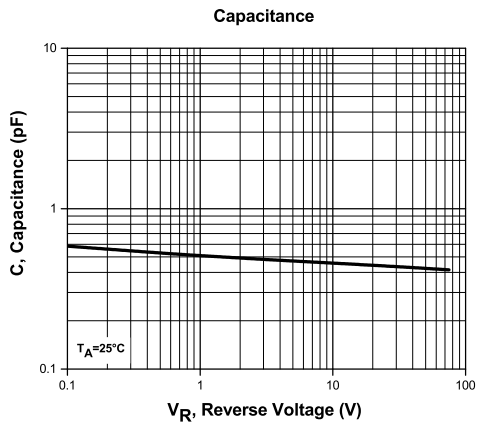
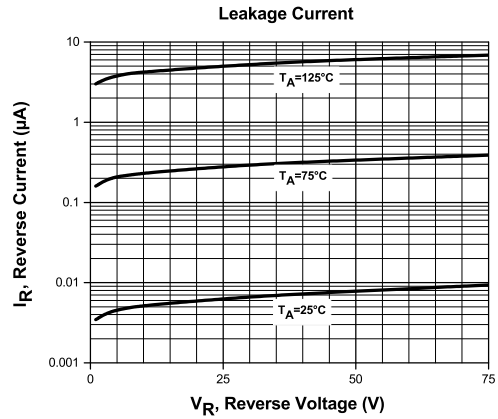
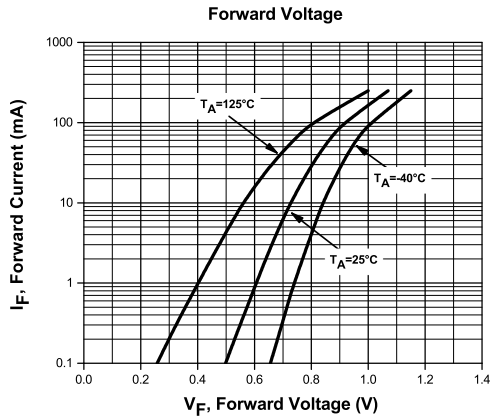

R7 (12-January 2016)

CMPD914

SURFACE MOUNT SILICON  
HIGH SPEED  
SWITCHING DIODE



TYPICAL ELECTRICAL CHARACTERISTICS

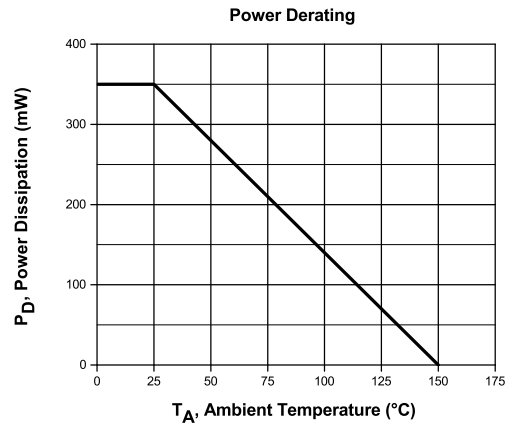
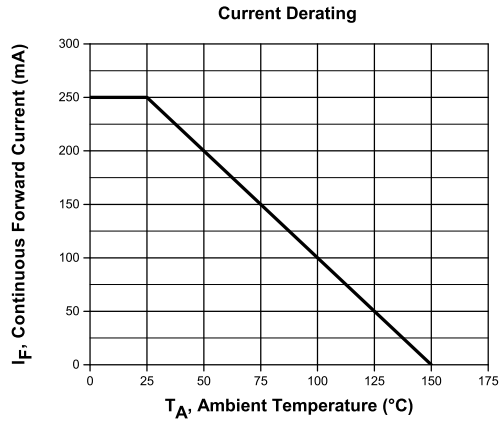

R7 (12-January 2016)

## OUTSTANDING SUPPORT AND SUPERIOR SERVICES



---

### PRODUCT SUPPORT

Central's operations team provides the highest level of support to insure product is delivered on-time.

- Supply management (Customer portals)
- Inventory bonding
- Consolidated shipping options
- Custom bar coding for shipments
- Custom product packing

---

### DESIGNER SUPPORT/SERVICES

Central's applications engineering team is ready to discuss your design challenges. Just ask.

- Free quick ship samples (2<sup>nd</sup> day air)
- Online technical data and parametric search
- SPICE models
- Custom electrical curves
- Environmental regulation compliance
- Customer specific screening
- Up-screening capabilities
- Special wafer diffusions
- PbSn plating options
- Package details
- Application notes
- Application and design sample kits
- Custom product and package development

---

### REQUESTING PRODUCT PLATING

1. If requesting Tin/Lead plated devices, add the suffix "TIN/LEAD" to the part number when ordering (example: 2N2222A TIN/LEAD).
2. If requesting Lead (Pb) Free plated devices, add the suffix "PBFREE" to the part number when ordering (example: 2N2222A PBFREE).

---

### CONTACT US

#### Corporate Headquarters & Customer Support Team

Central Semiconductor Corp.  
145 Adams Avenue  
Hauppauge, NY 11788 USA  
Main Tel: (631) 435-1110  
Main Fax: (631) 435-1824  
Support Team Fax: (631) 435-3388  
[www.centrasemi.com](http://www.centrasemi.com)

**Worldwide Field Representatives:**  
[www.centrasemi.com/wwreps](http://www.centrasemi.com/wwreps)

**Worldwide Distributors:**  
[www.centrasemi.com/wwdistributors](http://www.centrasemi.com/wwdistributors)

---

For the latest version of Central Semiconductor's **LIMITATIONS AND DAMAGES DISCLAIMER**, which is part of Central's Standard Terms and Conditions of sale, visit: [www.centrasemi.com/terms](http://www.centrasemi.com/terms)

# Mouser Electronics

Authorized Distributor

Click to View Pricing, Inventory, Delivery & Lifecycle Information:

[Central Semiconductor:](#)

[CMPD914](#) [CMPD914E TR](#) [CMPD914 TR](#) [CMPD914 BK](#)