

Contact insert - HC-D 64-I-CT-M - 1584431

Please be informed that the data shown in this PDF Document is generated from our Online Catalog. Please find the complete data in the user's documentation. Our General Terms of Use for Downloads are valid (<http://phoenixcontact.com/download>)



HEAVYCON male insert, D64 series, 64-pos., crimp connection

Your advantages

- Can be used in rail vehicles, satisfy DIN EN 45545-2 with requirement sets R22, R23, and R24 in hazard levels HL1, HL2, and HL3.
- For fast coding with plastic profile (Order No. 1410916, type CP-HC-S)



Key Commercial Data

Packing unit	1 pc
GTIN	
GTIN	4046356142694

Technical data

General

Note	For HC-D64 housing, crimp contacts CK1,6-ED (crimp contacts not included in scope of supply)
Connection method	Crimp connection
Number of connections per position	1
Degree of pollution	3
Overvoltage category	III
Number of positions	64+PE
Insertion/withdrawal cycles	≥ 500
Size	B24
Conductor cross section	0.14 mm ² ... 2.5 mm ²
Connection cross section AWG	26 ... 14
Stripping length of the individual wire	8 mm (0.14 ... 1.5 mm ²)
	6 mm (2.5 mm ²)
Assembly instructions	To ensure correct use, installation in housing with IP54 protection or better is required

Contact insert - HC-D 64-I-CT-M - 1584431

Technical data

General

Connection	Connectors may be plugged in only when there is no load/voltage.
------------	--

Ambient conditions

Ambient temperature (operation)	-40 °C ... 125 °C (including heating up of contacts)
---------------------------------	--

Material data

Contact material	Copper alloy
Contact surface material	Ag (alternatively Au)
Contact carrier material	PC
Standards/regulations	PC: Fire protection in rail vehicles - requirement sets R22, R23, and R24 acc. to DIN EN 45545-2 (Risk level HL1 - HL3)

Electrical characteristics

Rated voltage (III/3)	250 V
Rated surge voltage	4 kV
Rated current	10 A

Standards and Regulations

Constructional and testing regulations	DIN VDE 0627/86
	DIN VDE 0110/02.79
	DIN VDE 0110-1/04.97
	IEC 60664-1, DIN IEC 60512
	IEC 60352
Flammability rating according to UL 94	V0

Environmental Product Compliance

China RoHS	Environmentally friendly use period: unlimited = EFUP-e
	No hazardous substances above threshold values

Drawings

Contact insert - HC-D 64-I-CT-M - 1584431

Schematic diagram

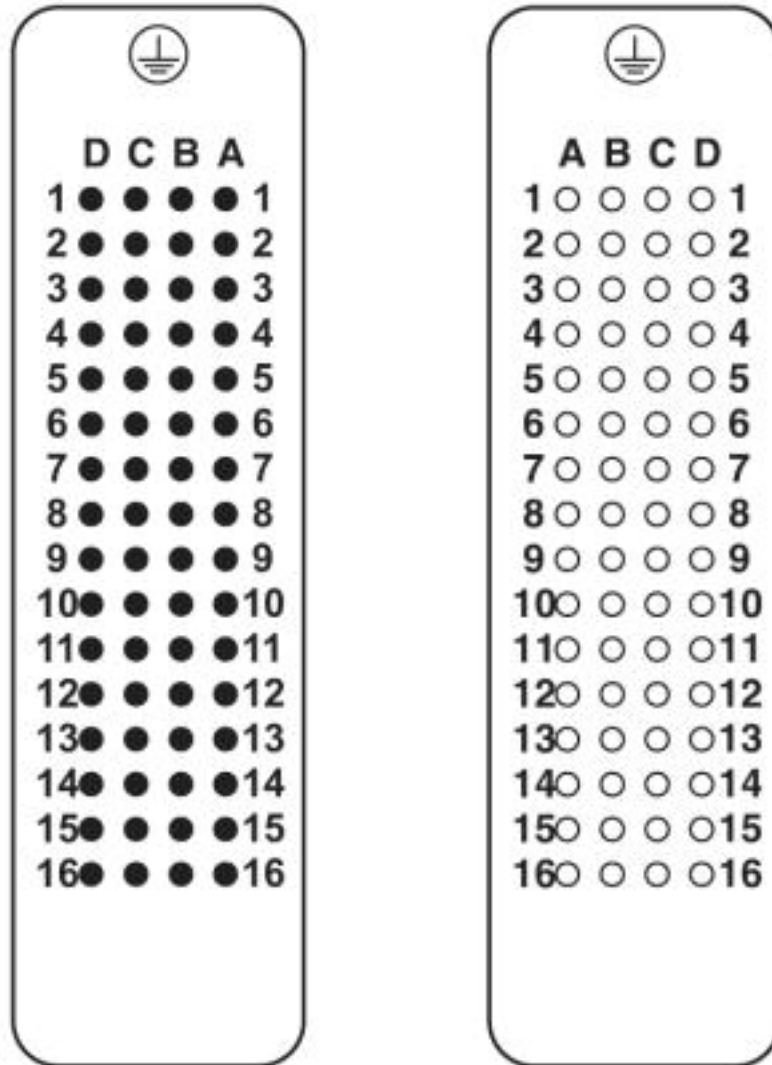

Connector pin assignment connection side: Left pin; right socket

Contact insert - HC-D 64-I-CT-M - 1584431

Diagram

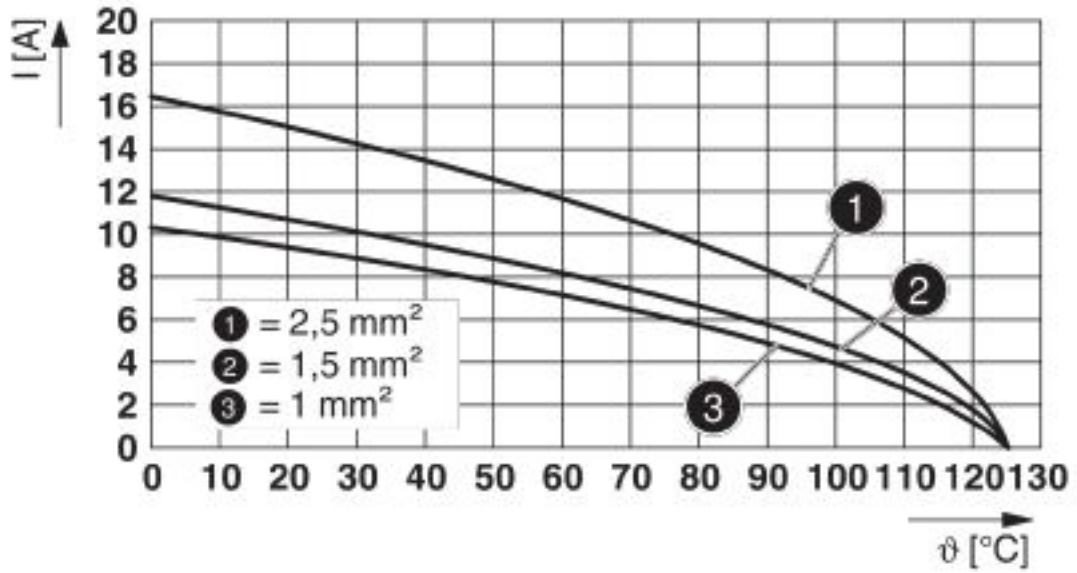

Derating diagram turned contacts

Dimensional drawing

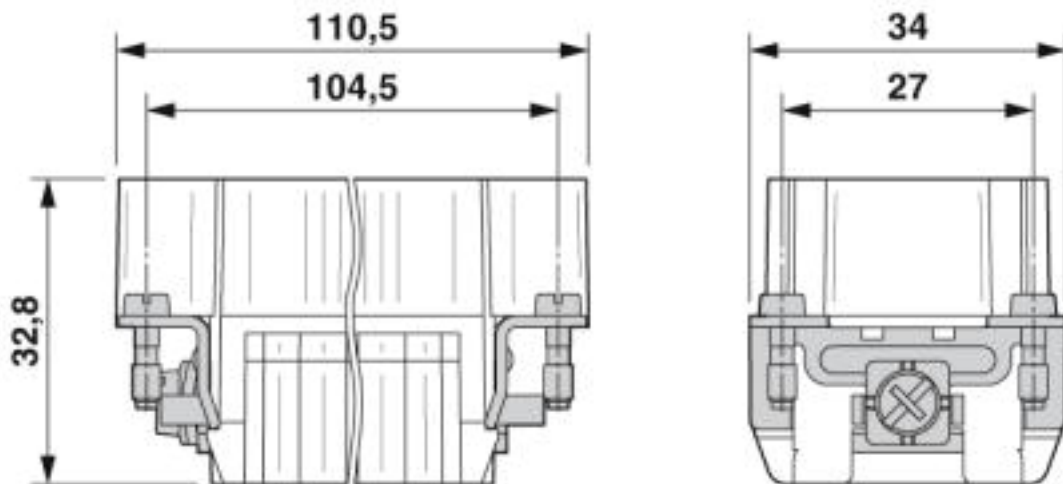

Male insert

Contact insert - HC-D 64-I-CT-M - 1584431

Dimensional drawing

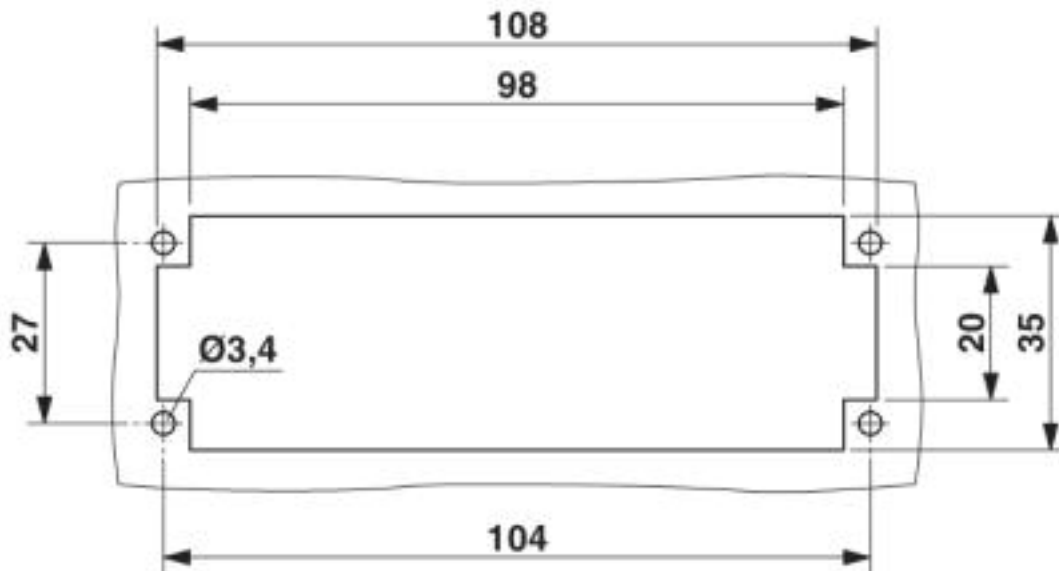

Mounting cutout when used without housing

Classifications

eCl@ss

eCl@ss 4.0	27140800
eCl@ss 4.1	27140800
eCl@ss 5.0	27143400
eCl@ss 5.1	27261200
eCl@ss 6.0	27261200
eCl@ss 7.0	27440205
eCl@ss 8.0	27440205
eCl@ss 9.0	27440205

ETIM

ETIM 2.0	EC000438
ETIM 3.0	EC000438
ETIM 4.0	EC000438
ETIM 5.0	EC000438
ETIM 6.0	EC000438
ETIM 7.0	EC000438

UNSPSC

UNSPSC 6.01	30211923
UNSPSC 7.0901	39121522
UNSPSC 11	39121522
UNSPSC 12.01	39121522

Contact insert - HC-D 64-I-CT-M - 1584431

Classifications

UNSPSC

UNSPSC 13.2	39121522
UNSPSC 18.0	39121522
UNSPSC 19.0	39121522
UNSPSC 20.0	39121522
UNSPSC 21.0	39121522

Approvals

Approvals

Approvals

CSA / UL Recognized / EAC / DNV GL / EAC

Ex Approvals

Approval details

CSA		http://www.csagroup.org/services-industries/product-listing/	13631
Nominal voltage UN		600 V	
Nominal current IN		7 A	
mm ² /AWG/kcmil		14	

UL Recognized		http://database.ul.com/cgi-bin/XYV/template/LISEXT/1FRAME/index.htm	FILE E 118976
Nominal voltage UN		600 V	
Nominal current IN		10 A	
mm ² /AWG/kcmil		14	

EAC			RU C- DE.AI30.B.01102
-----	---	--	--------------------------

DNV GL		https://approvalfinder.dnvgl.com/	TAE000037S
--------	---	---	------------

Contact insert - HC-D 64-I-CT-M - 1584431

Approvals

EAC



RU C-
DE.BL08.B.00511

Accessories

Accessories

Assembly tool

Assembly tool - UNIFOX MT-CK 1.6/2.5 - 1089092



Assembly tool, for CK 1.6... crimp contacts for small conductor cross sections

Coding element

Coding element - HC-CBU - 1676860



Coding socket for coding up to 16 connectors

Coding bolt - HC-CB - 1772722



Coding pin, prevents mismatching of up to six connectors with an identical number of positions

Coding element - HC-CST - 1676857



Coding peg for coding up to 16 connectors

Contact insert - HC-D 64-I-CT-M - 1584431

Accessories

Coding profile - CP-HC-S - 1410916



Coding profile, 4 elements per star, for insertion in a coding keyway, for contact inserts HC-BB... / HC-A10-I-UT... / HC-A16-I-UT...

Crimp contact

Crimp contact - CK1,6-ED-0,37ST AG - 1663336



Turned 1.6 crimp contact, individual male contact, core diameter 0.14 to 0.37 mm², silver-plated

Crimp contact - CK1,6-ED-0,50ST AG - 1663349



Turned 1.6 crimp contact, individual male contact, core diameter 0.5 mm², silver-plated

Crimp contact - CK1,6-ED-0,75ST AG - 1663352



Turned 1.6 crimp contact, individual male contact, core diameter 0.75 mm², silver-plated

Crimp contact - CK1,6-ED-1,00ST AG - 1663365



Turned 1.6 crimp contact, individual male contact, core diameter 0.75 to 1.00 mm², silver-plated

Contact insert - HC-D 64-I-CT-M - 1584431

Accessories

Crimp contact - CK1,6-ED-1,50ST AG - 1663378



Turned 1.6 crimp contact, individual male contact, core diameter 1.5 mm², silver-plated

Crimp contact - CK1,6-ED-2,50ST AG - 1663381



Turned 1.6 crimp contact, individual male contact, core diameter 2.5 mm², silver-plated

Crimp contact - CK1,6-ED-0,37ST AU - 1674901



Turned 1.6 crimp contact, individual male contact, core diameter 0.14 to 0.37 mm², gold-plated

Crimp contact - CK1,6-ED-0,50ST AU - 1672453



Turned 1.6 crimp contact, individual male contact, core diameter 0.5 mm², gold-plated

Crimp contact - CK1,6-ED-0,75ST AU - 1674914



Turned 1.6 crimp contact, individual male contact, core diameter 0.75 mm², gold-plated

Contact insert - HC-D 64-I-CT-M - 1584431

Accessories

Crimp contact - CK1,6-ED-1,00ST AU - 1674888



Turned 1.6 crimp contact, individual male contact, core diameter 0.75 to 1.00 mm², gold-plated

Crimp contact - CK1,6-ED-1,50ST AU - 1674875



Turned 1.6 crimp contact, individual male contact, core diameter 1.5 mm², gold-plated

Crimp contact - CK1,6-ED-2,50ST AU - 1674927



Turned 1.6 crimp contact, individual male contact, core diameter 2.5 mm², gold-plated

Crimping tool

Crimping pliers - CRIMPFOX-TC 4 - 1212113



Crimping pliers, for CK 1,6-ED..., CK 2,5-ED..., CK 4,0-ED... turned contacts, 4 marked die stations, unlockable pressure lock, lateral entry, incl. positioning tool

DIN rail mounting frame

DIN rail mounting frame - HC-SMR-B24 - 1687985



HEAVYCON DIN rail mounting frame, for contact inserts of type B24

Docking frame

Contact insert - HC-D 64-I-CT-M - 1584431

Accessories

Docking frames - HC-B 24-ANDOCK - 1586141



Docking frame for racks, for contact inserts of B24 type, with four M5 flat headed screws, rack balance x/y axis +/- 1.5 mm

Mounting material

Screw - HC-B-PES - 1604997



PE screw, for contact inserts HC-B / HC-BB / HC-DD / HC-D40 / HC-D64

PE multiplier - HC-B-3PE - 1644326



PE multiplier, for three PE connections, for HC-B (besides HC-B..E..ZZ) / HC-BB / HC-DD / HC-D40 / HC-D64 contact inserts

Strain relief clamp - HC-B-ZG - 1685327



Strain relief clamps contact inserts of series: B-, BB-, D 40, D 64, DD and HV, straight cable exit

Strain relief clamp - HC-B-ZS - 1685330



Strain relief clamps contact inserts of series: B-, BB-, D 40, D 64, DD and HV, lateral cable exit

Universal tools

Contact insert - HC-D 64-I-CT-M - 1584431

Accessories

Contact removal tool - UNIFOX RT-CK 1.6 - 1072069



Contact removal tool, for turned and rolled CK- 1.6-... contacts

Additional products

Contact insert - HC-D 64-I-CT-F - 1584444



HEAVYCON female insert, D64 series, 64-pos., crimp connection

Phoenix Contact 2020 © - all rights reserved
<http://www.phoenixcontact.com>

PHOENIX CONTACT GmbH & Co. KG
Flachsmarktstr. 8
32825 Blomberg
Germany
Tel. +49 5235 300
Fax +49 5235 3 41200
<http://www.phoenixcontact.com>