

200mA High Speed LDO Regulator, Output Capacitor-Less, Low Power Consumption

■ GENERAL DESCRIPTION

The XC6501 series is a high speed, low noise CMOS LDO regulator that can provide stable output voltages even without a load capacitor C_L . This is possible because phase compensation is carried out internally unlike other LDOs where it is done externally. The series consists of a reference voltage source, driver transistor, error amplifier, current limit circuit, and phase compensation circuit.

The CE function enables the circuit to be put into stand-by mode by inputting a low level signal to the CE pin thereby reducing current consumption from an already low $13 \mu\text{A}$ (in operation) to less than $0.1 \mu\text{A}$. In the stand-by mode, if a C_L capacitor is used, the electric charge stored at C_L can be discharged via the internal auto-discharge switch and as a result, the V_{OUT} pin quickly returns to the V_{SS} level.

The current limit fold-back circuit operates as a short circuit protection and a current limiter function for the output pin.

■ APPLICATIONS

- Smart phones / Mobile phones
- Portable games
- Modules (wireless, cameras, etc.)
- Bluetooth
- Digital-TV tuners

■ FEATURES

Maximum Output Current	: 200mA
Operating Voltage Range	: 1.4~6.0V
Output Voltage Range	: 1.2~5.0V
Output Voltage Accuracy	: $\pm 1\%$ or $\pm 0.02\text{V}$
Dropout Voltage	: $150\text{mV}@I_{\text{OUT}}=100\text{mA}, V_{\text{OUT}}=2.8\text{V}$
Low Power Supply	: $13 \mu\text{A} @V_{\text{OUT}}=2.8\text{V}$
Stand-by Current	: Less than $0.1 \mu\text{A}$
Ripple Rejection	: $50\text{dB}@f=1\text{kHz}, V_{\text{OUT}}=2.8\text{V}$
Protection Circuits	: Current limit (300mA, TYP.) Short circuit protection
Output capacitor is not required	: Internal phase compensation
C_L High Speed Auto Discharge	
Operating Ambient Temperature	: $-40^\circ\text{C} \sim +85^\circ\text{C}$
Packages	: SOT-25, SSOT-24, USP-4, USPN-4, USP-3, WLP-4-01
Environmentally Friendly	: EU RoHS Compliant, Pb Free

■ TYPICAL APPLICATION CIRCUIT

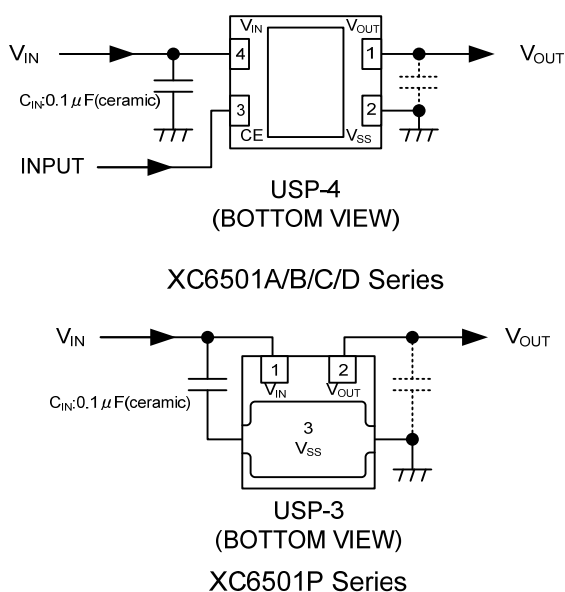

■ TYPICAL PERFORMANCE CHARACTERISTICS

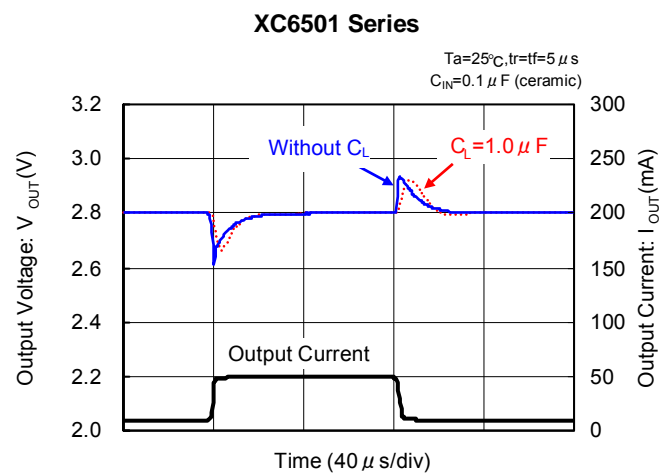

XC6501 Series

PIN CONFIGURATION

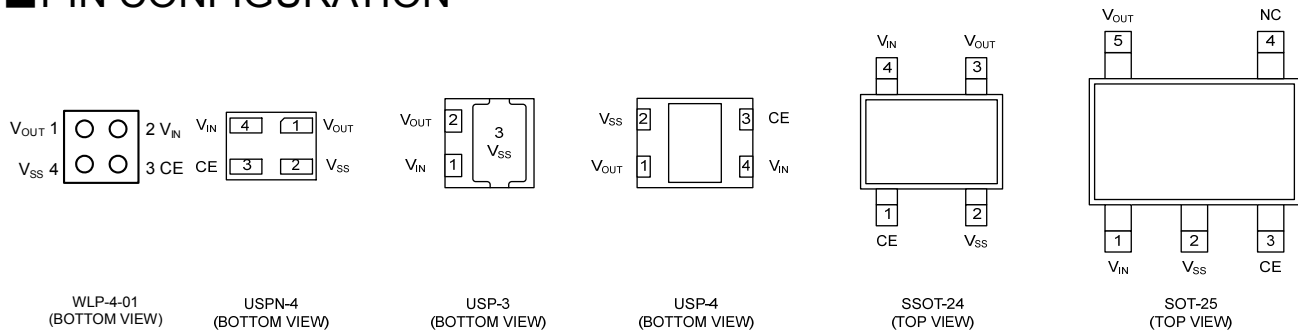

*The heat dissipation pad of the USP-4 package is reference to solder as the reference mount pattern and metal mask pattern for mounting strength. The mount pattern should be electrically opened or connected to the V_{SS} (No.2) pin.

PIN ASSIGNMENT

PIN NUMBER						PIN NAME	FUNCTIONS
WLP-4-01	USP-3	USP-4	SSOT-24	SOT-25	USPN-4		
2	1	4	4	1	4	V _{IN}	Power Supply Input
1	2	1	3	5	1	V _{OUT}	Output
4	3	2	2	2	2	V _{SS}	Ground
3	-	3	1	3	3	CE	ON/OFF Control
-	-	-	-	4	-	NC	No Connection

FUNCTION CHART

1)XC6501 series A/B type

PIN NAME	SIGNAL	STATUS
CE	L	OFF
	H	ON
	OPEN	Undefined

2)XC6501 series C/D type

PIN NAME	SIGNAL	STATUS
CE	L	OFF
	H	ON
	OPEN	OFF

■ PRODUCT CLASSIFICATION

● Ordering Information

XC6501①②③④⑤⑥-⑦^(*)

DESIGNATOR	ITEM	SYMBOL	DESCRIPTION
①	Regulator Type	A	CE High Active, Without CE Pull-down, Without C _L discharge
		B	CE High Active, Without CE Pull-down, With C _L discharge
		C	CE High Active, With CE Pull-down, Without C _L discharge
		D	CE High Active, With CE Pull-down, With C _L discharge
		P	3 pin, without CE pin (USP-3)
②③	Output Voltage	12~50	ex.)28V → ②=2, ③=8
④	Output Voltage Type [Accuracy]	1 ^(*)	0.1V increments ex.)1.80V → ②=1, ③=8, ④=1 [±0.02V @ 1.2V~1.9V, ±1% @ 2.0V~5.0V]
		A ^(*)	0.05V increments ex.)1.85V → ②=1, ③=8, ④=A [±0.02V @ 1.25V~1.95V, ±1% @ 2.05V~4.95V]
		2	0.1V increments ex.)1.80V → ②=1, ③=8, ④=2 [±0.03V @ 1.2V~1.4V, ±2% @ 1.5V~5.0V]
		B	0.05V increments ex.)1.85V → ②=1, ③=8, ④=B [±0.03V @ 1.25V~1.45V, ±2% @ 1.55V~4.95V]
⑤⑥-⑦ ^(*)	Packages (Order Unit)	HR	USP-3 ^(*) (3,000pcs/Reel)
		HR-G	USP-3 ^(*) (3,000pcs/Reel)
		GR	USP-4 (3,000pcs/Reel)
		GR-G	USP-4 (3,000pcs/Reel)
		NR	SSOT-24 (3,000pcs/Reel)
		NR-G	SSOT-24 (3,000pcs/Reel)
		MR	SOT-25 (3,000pcs/Reel)
		MR-G	SOT-25 (3,000pcs/Reel)
		7R-G	USPN-4 (5,000pcs/Reel)
0R-G	WLP-4-01 (5,000pcs/Reel)		

^(*) The "-G" suffix denotes Halogen and Antimony free as well as being fully EU RoHS compliant.

⁽²⁾ USP-3 is available only for XC6501P series.

⁽³⁾ They are not used in the WLP-4-01.

XC6501 Series

BLOCK DIAGRAMS

1) XC6501 Series A type

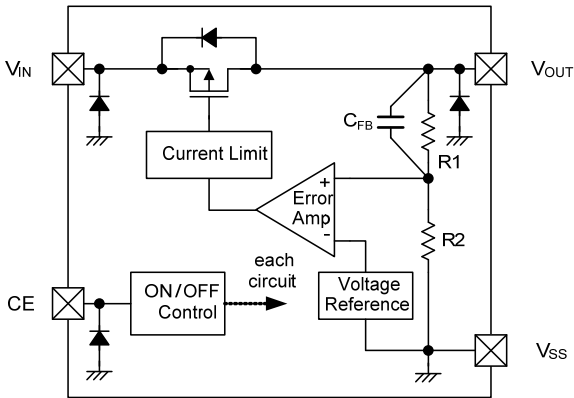

2) XC6501 Series B type

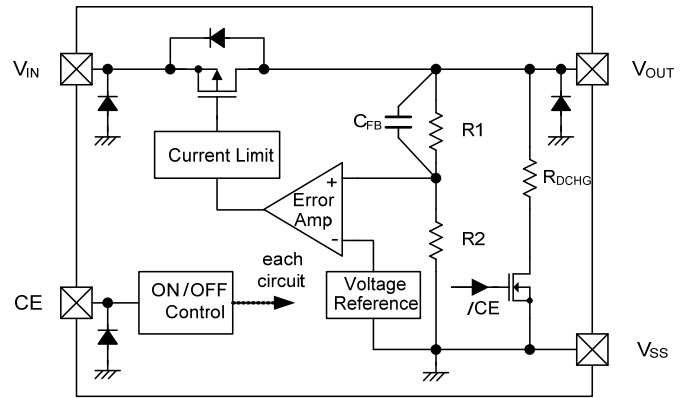

3) XC6501 Series C type

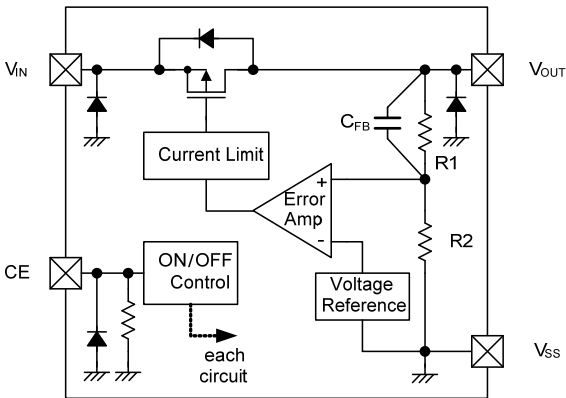

4) XC6501 Series D type

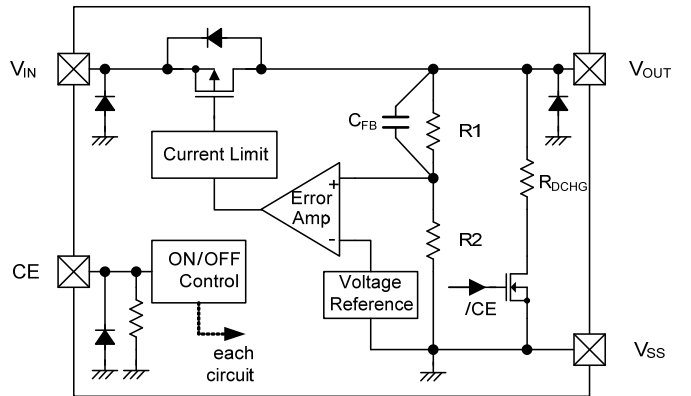

5) XC6501 Series P type

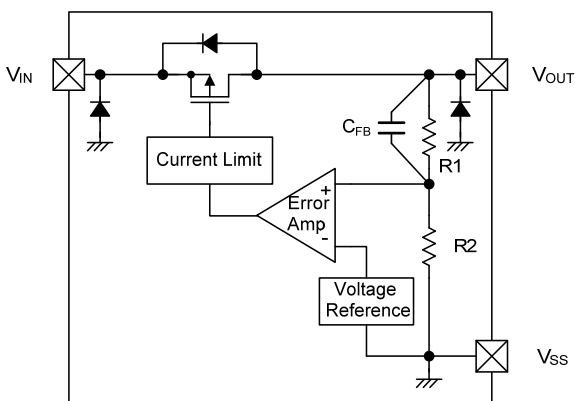

*Diodes inside the circuit are an ESD protection diode and a parasitic diode.

■ ABSOLUTE MAXIMUM RATINGS

PARAMETER		SYMBOL	RATINGS	UNITS
Input Voltage		V_{IN}	-0.3~+6.5	V
Output Current		I_{OUT}	400 ^(*1)	mA
Output Voltage		V_{OUT}	-0.3~ $V_{IN}+0.3$ or +6.5 ^(*2)	V
CE Input Voltage		V_{CE}	-0.3~+6.5	V
Power Dissipation	USPN-4	Pd	100	mW
			600 (PCB mounted) ^(*3)	
	USP-3		120	
			1000 (PCB mounted) ^(*3)	
	USP-4		120	
			1000 (PCB mounted) ^(*3)	
	SSOT-24		150	
			500 (PCB mounted) ^(*3)	
SOT-25	250			
	600 (PCB mounted) ^(*3)			
WLP-4-01	660 (PCB mounted) ^(*3)			
	Operating Ambient Temperature		T_{opr}	-40~+85
Storage Temperature		T_{stg}	-55~+125	°C

* All voltages are described based on the V_{SS} pin.

(*1) $I_{OUT} \leq Pd / (V_{IN} - V_{OUT})$

(*2) The maximum value should be $V_{IN}+0.3$ or +6.5 in the lowest.

(*3) The power dissipation figure shown is PCB mounted and is for reference only. Please refer to page 26~31 for details.

ELECTRICAL CHARACTERISTICS

●XC6501 Series A/B/C/D Type

Ta=25°C

PARAMETER	SYMBOL	CONDITIONS	MIN.	TYP.	MAX.	UNITS	CIRCUIT	
Output Voltage	V _{OUT(E)} ^(*)	V _{OUT(T)} ^(**) ≤ 1.95V V _{CE} =V _{IN} , I _{OUT} =10mA	-0.02 ^(***) -0.03 ^(***)	V _{OUT(T)}	+0.02 ^(***) +0.03 ^(***)	V	①	
		V _{OUT(T)} ≥ 2.0V V _{CE} =V _{IN} , I _{OUT} =10mA	×0.99 ^(***) ×0.98 ^(***)		×1.01 ^(***) ×1.02 ^(***)			
Maximum Output Current	I _{OUTMAX}	V _{CE} =V _{IN}	200	-	-	mA	①	
Load Regulation	ΔV _{OUT}	V _{CE} =V _{IN} , 0.1mA ≤ I _{OUT} ≤ 100mA	-	15	45	mV	①	
Dropout Voltage ^(*)	V _{dif}	V _{CE} =V _{IN} , I _{OUT} =100mA	-	E-1 ^(***)		mV	①	
Supply Current	I _{SS}	V _{IN} =V _{CE} =6.0V, I _{OUT} =0mA	E-2 ^(***)			μA	②	
Stand-by Current	I _{STBY}	V _{IN} =6.0V, V _{CE} =V _{SS}	-	0.01	0.1	μA	②	
Line Regulation	ΔV _{OUT} / (ΔV _{IN} ·V _{OUT})	V _{OUT(T)} +0.5V ≤ V _{IN} ≤ 6.0V, V _{CE} =V _{IN} , I _{OUT} =30mA	-	0.10	0.20	%/V	①	
Input Voltage	V _{IN}		1.4	-	6.0	V	①	
Output Voltage Temperature Characteristics	ΔV _{OUT} / (ΔT _{opr} ·V _{OUT})	V _{CE} =V _{IN} , I _{OUT} =30mA -40°C ≤ T _{opr} ≤ 85°C	-	±100	-	ppm/°C	①	
Power Supply Rejection Ratio	PSRR	V _{OUT(T)} ≤ 4.75V V _{IN} =[V _{OUT(T)} +1.0]V _{DC} +0.5V _{p-pAC} V _{CE} =V _{IN} , I _{OUT} =30mA, f=1kHz	-	50	-	dB	③	
		V _{OUT(T)} ≥ 4.80V V _{IN} =5.75V _{DC} +0.5V _{p-pAC} V _{CE} =V _{IN} , I _{OUT} =30mA, f=1kHz						
Current Limit	I _{LIM}	V _{CE} =V _{IN}	210	300	-	mA	①	
Short - Circuit Current	I _{SHORT}	V _{CE} =V _{IN} , V _{OUT} is short-circuited at the V _{SS} level	-	25	-	mA	①	
CE High Level Voltage	V _{CEH}		1.0	-	6.0	V	①	
CE Low Level Voltage	V _{CEL}		V _{SS}	-	0.25	V	①	
CE High Level Current	I _{CEH}	V _{CE} =V _{IN} =6.0V	XC6501A/B	-0.1	-	0.1	μA	①
			XC6501C/D	3.5	6.0	10		
CE Low Level Current	I _{CEL}	V _{CE} =V _{IN}	-0.1	-	0.1	μA	①	
Auto-Discharge Resistance ^(*)	R _{DCHG}	V _{IN} =6.0V, V _{OUT} =1.2V, V _{CE} =V _{SS}	-	250	300	Ω	①	
		V _{IN} =6.0V, V _{OUT} =5.0V, V _{CE} =V _{SS}	-	400	480	Ω		

Notes:

Unless otherwise stated regarding input voltage conditions, V_{IN}=V_{OUT(T)}^(**)+1.0V.

*1: V_{OUT(E)}: An actual output voltage when an amply stabilized(V_{OUT(T)}+1.0V) is supplied with constant I_{OUT}.

*2: V_{OUT(T)}: Nominal output voltage value

*3: MIN and MAX values of V_{OUT(E)} are shown in the voltage table "E-0".

*4: V_{dif}={V_{IN1} - V_{OUT1}}

V_{IN1}: The input voltage when V_{OUT1} appears as input voltage is gradually decreased.

V_{OUT1}: A voltage equal to 98% of the output voltage when an amply stabilized I_{OUT} (V_{OUT(T)}+1.0V) is input.

*5: Please refer to page E-1.

*6: Please refer to page E-2.

*7: This function is built in the XC6501B/D series only.

The XC6501A/C series discharges by only R1+ R2 resistors as shown in the block diagrams.

■ ELECTRICAL CHARACTERISTICS (Continued)

● XC6501 Series P Type

Ta=25°C

PARAMETER	SYMBOL	CONDITIONS	MIN.	TYP.	MAX.	UNITS	CIRCUIT
Output Voltage	V _{OUT(E)} ^(*1)	V _{OUT(T)} ^(*2) ≤ 1.95V I _{OUT} = 10mA	-0.02 ^(*3)	V _{OUT(T)}	+0.02 ^(*3)	V	①
		V _{OUT(T)} ≥ 2.0V I _{OUT} = 10mA	×0.99 ^(*3)		×1.01 ^(*3)		
Maximum Output Current	I _{OUTMAX}		200	-	-	mA	①
Output Voltage	ΔV _{OUT}	0.1mA ≤ I _{OUT} ≤ 100mA	-	15	45	mV	①
Dropout Voltage ^(*4)	V _{dif}	I _{OUT} = 100mA	-	E-1 ^(*5)		mV	①
Supply Current	I _{SS}	V _{IN} = 6.0V, I _{OUT} = 0mA	E-2 ^(*6)			μA	②
Line Regulation	ΔV _{OUT} / (ΔV _{IN} · V _{OUT})	V _{OUT(T)} + 0.5V ≤ V _{IN} ≤ 6.0V, I _{OUT} = 30mA	-	0.10	0.20	%/V	①
Input Voltage	V _{IN}		1.4	-	6.0	V	①
Output Voltage Temperature Characteristics	ΔV _{OUT} / (ΔT _{opr} · V _{OUT})	I _{OUT} = 30mA -40°C ≤ T _{opr} ≤ 85°C	-	±100	-	ppm	①
Power Supply Rejection Ratio	PSRR	V _{OUT(T)} ≤ 4.75V V _{IN} = {V _{OUT(T)} + 1.0} V _{DC} + 0.5V _{p-pAC} I _{OUT} = 30mA, f = 1kHz	-	50	-	dB	③
		V _{OUT(T)} ≥ 4.80V V _{IN} = 5.75V _{DC} + 0.5V _{p-pAC} I _{OUT} = 30mA, f = 1kHz					
Current Limit	I _{LIM}		210	300	-	mA	①
Short Circuit Current	I _{SHORT}	V _{OUT} is short-circuited at the V _{SS} level	-	25	-	mA	①

Notes:

Unless otherwise stated regarding input voltage conditions, V_{IN} = V_{OUT(T)}^(*2) + 1.0V.

*1: V_{OUT(E)}: An actual output voltage when an amply stabilized (V_{OUT(T)} + 1.0V) is supplied with constant I_{OUT}.

*2: V_{OUT(T)}: Nominal output voltage value

*3: MIN and MAX values of V_{OUT(E)} are shown in the voltage table "E-0".

*4: V_{dif} = {V_{IN1} - V_{OUT1}}

V_{IN1}: The input voltage when V_{OUT1} appears as input voltage is gradually decreased.

V_{OUT1}: A voltage equal to 98% of the output voltage when an amply stabilized I_{OUT} (V_{OUT(T)} + 1.0V) is input.

*5: Please refer to page E-1.

*6: Please refer to page E-2.

■ ELECTRICAL CHARACTERISTICS (Continued)

● Voltage Chart

NOMINAL VOLTAGE (V)	E-0				E-1		E-2		
	OUTPUT VOLTAGE (Standard) (V)		OUTPUT VOLTAGE (WLP-4-01) (V)		DROPOUT VOLTAGE (mV)		SUPPLY CURRENT (μA)		
	$V_{OUT(E)}$		$V_{OUT(E)}$		V_{dif}		I_{SS}		
$V_{OUT(T)}$	MIN.	MAX.	MIN.	MAX.	TYP.	MAX.	MIN.	TYP.	MAX.
1.20	1.1800	1.2200	1.1700	1.2300	440	690	5	11	17
1.25	1.2300	1.2700	1.2200	1.2800					
1.30	1.2800	1.3200	1.2700	1.3300					
1.35	1.3300	1.3700	1.3200	1.3800					
1.40	1.3800	1.4200	1.3700	1.4300	300	610			
1.45	1.4300	1.4700	1.4200	1.4800					
1.50	1.4800	1.5200	1.4700	1.5300					
1.55	1.5300	1.5700	1.5190	1.5810	260	530			
1.60	1.5800	1.6200	1.5680	1.6320					
1.65	1.6300	1.6700	1.6170	1.6830					
1.70	1.6800	1.7200	1.6660	1.7340					
1.75	1.7300	1.7700	1.7150	1.7850	230	470			
1.80	1.7800	1.8200	1.7640	1.8360					
1.85	1.8300	1.8700	1.8130	1.8870					
1.90	1.8800	1.9200	1.8620	1.9380					
1.95	1.9300	1.9700	1.9110	1.9890	200	430			
2.00	1.9800	2.0200	1.9600	2.0400					
2.05	2.0295	2.0705	2.0090	2.0910					
2.10	2.0790	2.1210	2.0580	2.1420					
2.15	2.1285	2.1715	2.1070	2.1930	190	410			
2.20	2.1780	2.2220	2.1560	2.2440					
2.25	2.2275	2.2725	2.2050	2.2950					
2.30	2.2770	2.3230	2.2540	2.3460					
2.35	2.3265	2.3735	2.3030	2.3970	210	380			
2.40	2.3760	2.4240	2.3520	2.4480					
2.45	2.4255	2.4745	2.4010	2.4990					
2.50	2.4750	2.5250	2.4500	2.5500					
2.55	2.5245	2.5755	2.4990	2.6010	150	360			
2.60	2.5740	2.6260	2.5480	2.6520					
2.65	2.6235	2.6765	2.5970	2.7030					
2.70	2.6730	2.7270	2.6460	2.7540					
2.75	2.7225	2.7775	2.6950	2.8050	7	14			
2.80	2.7720	2.8280	2.7440	2.8560					
2.85	2.8215	2.8785	2.7930	2.9070					
2.90	2.8710	2.9290	2.8420	2.9580					
2.95	2.9205	2.9795	2.8910	3.0090	20				
3.00	2.9700	3.0300	2.9400	3.0600					
3.05	3.0195	3.0805	2.9890	3.1110					

■ ELECTRICAL CHARACTERISTICS (Continued)

● Voltage Table (continued)

NOMINAL VOLTAGE (V)	E-0				E-1		E-2		
	OUTPUT VOLTAGE (Standard)		OUTPUT VOLTAGE (WLP-4-01)		DROPOUT VOLTAGE		SUPPLY CURRENT		
	(V)		(V)		(mV)		(μA)		
V _{OUT(T)}	V _{OUT(E)}		V _{OUT(E)}		V _{dif}		I _{SS}		
	MIN.	MAX.	MIN.	MAX.	TYP.	MAX.	MIN.	TYP.	MAX.
3.10	3.0690	3.1310	3.0380	3.1620	150	360	7	14	21
3.15	3.1190	3.1820	3.0870	3.2130					
3.20	3.1680	3.2320	3.1360	3.2640					
3.25	3.2175	3.2825	3.1850	3.3150					
3.30	3.2670	3.3330	3.2340	3.3660					
3.35	3.3165	3.3835	3.2830	3.4170					
3.40	3.3660	3.4340	3.3320	3.4680					
3.45	3.4155	3.4845	3.3810	3.5190					
3.50	3.4650	3.5350	3.4300	3.5700					
3.55	3.5145	3.5855	3.4790	3.6210					
3.60	3.5640	3.6360	3.5280	3.6720	130	340	15	22	
3.65	3.6135	3.6865	3.5770	3.7230					
3.70	3.6630	3.7370	3.6260	3.7740					
3.75	3.7125	3.7875	3.6750	3.8250					
3.80	3.7620	3.8380	3.7240	3.8760					
3.85	3.8115	3.8885	3.7730	3.9270					
3.90	3.8610	3.9390	3.8220	3.9780					
3.95	3.9105	3.9895	3.8710	4.0290					
4.00	3.9600	4.0400	3.9200	4.0800					
4.05	4.0095	4.0905	3.9690	4.1310					
4.10	4.0590	4.1410	4.0180	4.1820					
4.15	4.1085	4.1915	4.0670	4.2330					
4.20	4.1580	4.2420	4.1160	4.2840	120	330	8	23	
4.25	4.2075	4.2925	4.1650	4.3350					
4.30	4.2570	4.3430	4.2140	4.3860					
4.35	4.3065	4.3935	4.2630	4.4370					
4.40	4.3560	4.4440	4.3120	4.4880					
4.45	4.4055	4.4945	4.3610	4.5390					
4.50	4.4550	4.5450	4.4100	4.5900					
4.55	4.5045	4.5955	4.4590	4.6410					
4.60	4.5540	4.6460	4.5080	4.6920					
4.65	4.6035	4.6965	4.5570	4.7430					
4.70	4.6530	4.7470	4.6060	4.7940					
4.75	4.7025	4.7975	4.6550	4.8450					
4.80	4.7520	4.8480	4.7040	4.8960					
4.85	4.8015	4.8985	4.7530	4.9470					
4.90	4.8510	4.9490	4.8020	4.9980					
4.95	4.9005	4.9995	4.8510	5.0490					
5.00	4.9500	5.0500	4.9000	5.1000					

OPERATIONAL EXPLANATION

The voltage divided by resistors R1 & R2 is compared with the internal reference voltage by the error amplifier. The P-channel MOSFET which is connected to the V_{OUT} pin is then driven by the subsequent output signal. The output voltage at the V_{OUT} pin is controlled & stabilized by a system of negative feedback. The current limit circuit and short protect circuit operate in relation to the level of output current. Further, the IC's internal circuitry can be shutdown via the CE pin's signal.

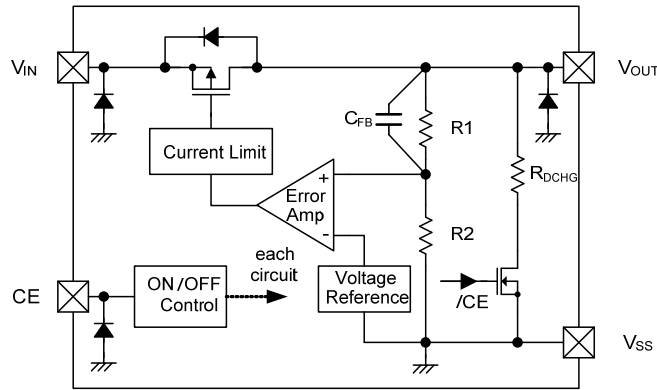

XC6501 Series B Type

<C_L High Speed Auto-Discharge Function>

The XC6501B/D series can discharge the electric charge in the output capacitor C_L, when a low signal to the CE pin, which enables a whole IC circuit turn off, is inputted via the N-channel transistor located between the V_{OUT} pin and the V_{SS} pin as shown in the BLOCK DIAGRAM. The C_L auto-discharge resistance value is set at 400Ω (V_{OUT}=5.0V @ V_{IN}=6.0V at typical). The discharge time of the output capacitor C_L is set by the C_L auto-discharge resistance R and the output capacitor C_L. By setting time constant of a C_L auto-discharge resistance value R_{DCHG} and an output capacitor value C_L as τ (τ=C x R_{DCHG}), the output voltage after discharge via the N-channel transistor is calculated by the following formulas.

$$V = V_{OUT(E)} \times e^{-t/\tau}$$

or an expanded formula is

$$t = \tau \ln(V_{OUT(E)}/V)$$

- V : Output voltage after discharge
- V_{OUT(E)} : Output voltage
- t : Discharge time
- τ : R_{DCHG} × C_L
- R_{DCHG} : C_L auto-discharge resistance
- C_L : Output capacitor

<Current Limiter, Short-Circuit Protection>

The XC6501 series' fold-back circuit operates as an output current limiter and a short protection of the output pin. When the load current reaches the current limit level, the fixed current limiter circuit operates and output voltage drops. When the output voltage is shorted to the V_{SS}, its current flow reached and minimized to about 25mA.

<CE Pin>

The IC's internal circuitry can be shutdown via the signal from the CE pin with the XC6501 series. In shutdown mode output at the V_{OUT} pin will be pulled down to the V_{SS} level via R1 & R2. However, as for the XC6501B/D series, the C_L auto-discharge resistor is connected in parallel to R1 and R2 while the power supply is applied to the V_{IN} pin. Therefore, time until the V_{OUT} pin reaches the V_{SS} level becomes short. The output voltage becomes unstable, when the CE pin is open. If this IC is used with the correct output voltage for the CE pin, the logic is fixed and the IC will operate normally. However, supply current may increase as a result of through current in the IC's internal circuitry when medium voltage is input.

■NOTES ON USE

1. Please use this IC within the stated absolute maximum ratings. The IC is liable to malfunction should the ratings be exceeded.
2. This IC achieves stable operation without an output capacitor C_L by internal phase compensation. However, wiring impedance is high, operations may become unstable due to noise and/or phase lag depending on output current. Please wire the input capacitor C_{IN} and the output capacitor C_L as close to the IC as possible.
3. Torex places an importance on improving our products and their reliability. We request that users incorporate fail-safe designs and post-aging protection treatment when using Torex products in their systems.

TEST CIRCUITS

● Circuit ①

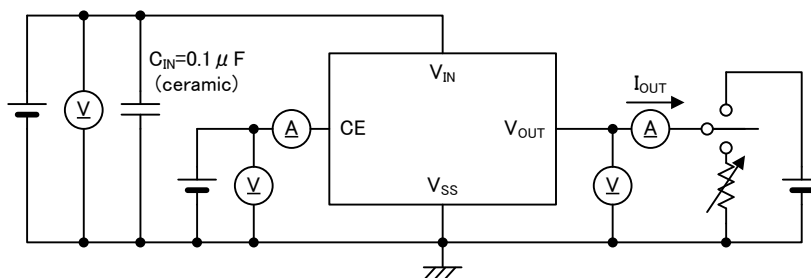

● Circuit ②

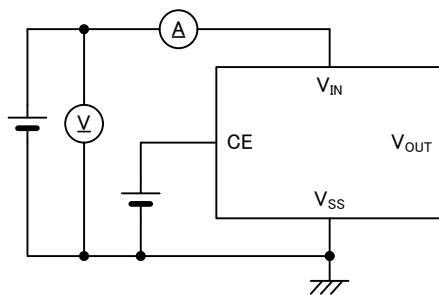

● Circuit ③

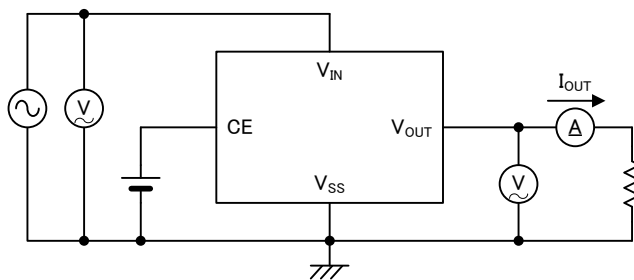

The CE pin does not exist in the XC6501 series P type, please disregard CE description in above test circuit.

■ TYPICAL PERFORMANCE CHARACTERISTICS

*CE Voltage condition: Unless otherwise stated, $V_{CE} = V_{IN}$

(1) Output Voltage vs. Output Current

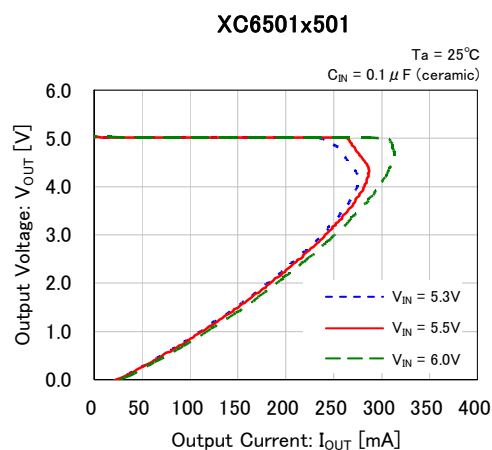
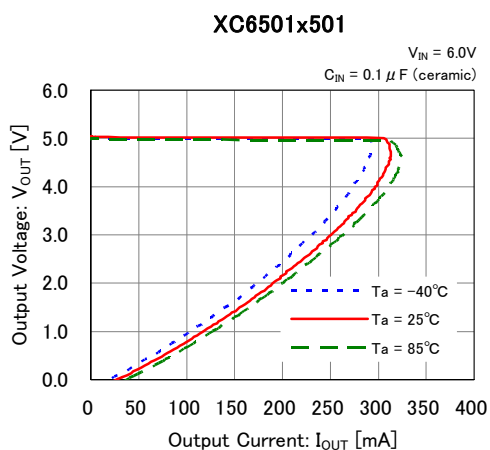
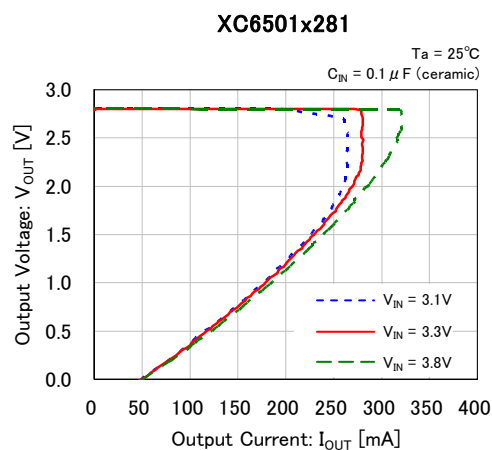
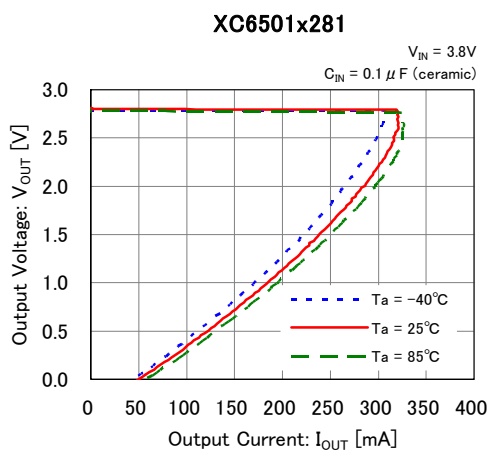
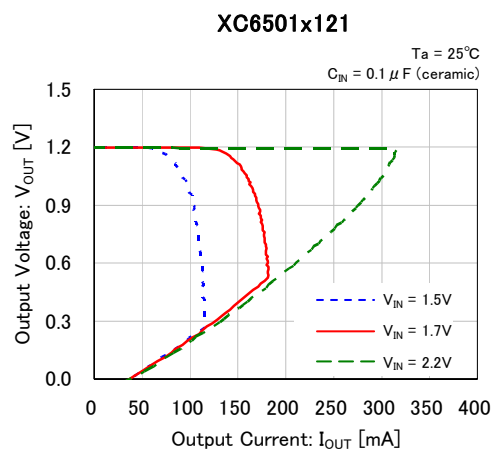
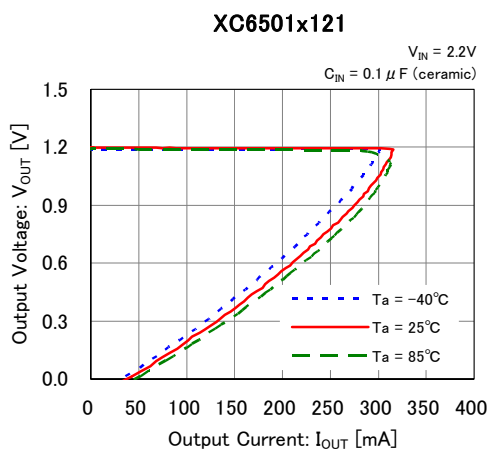

TYPICAL PERFORMANCE CHARACTERISTICS (Continued)

(2) Output Voltage vs. Input Voltage

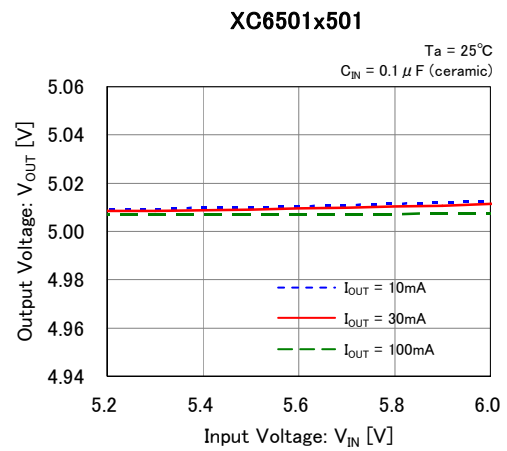
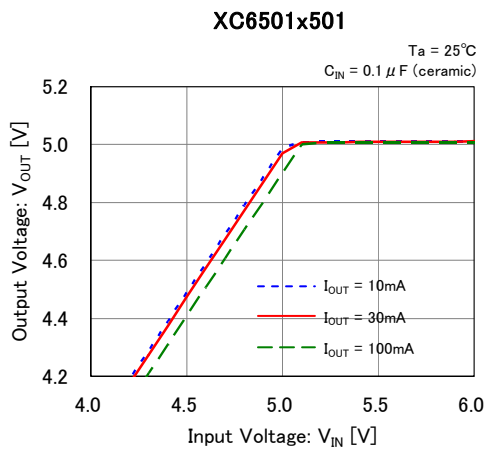
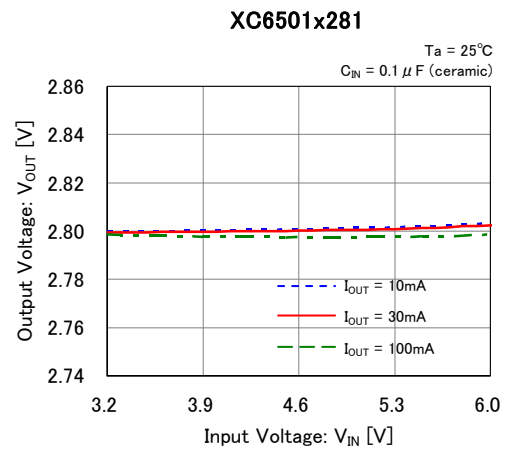
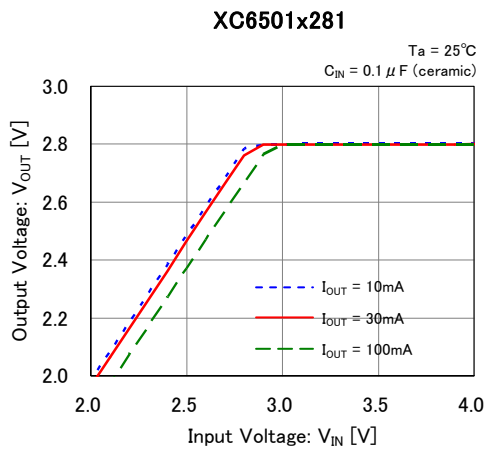
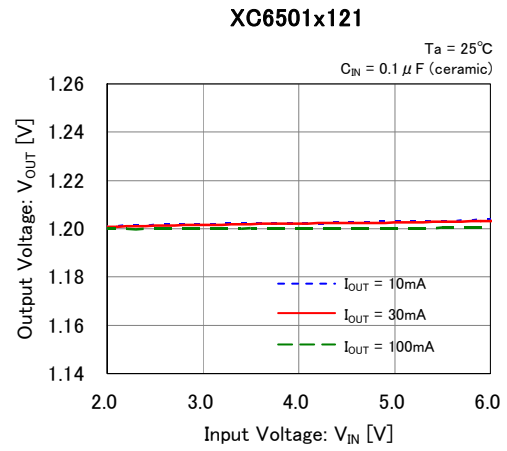
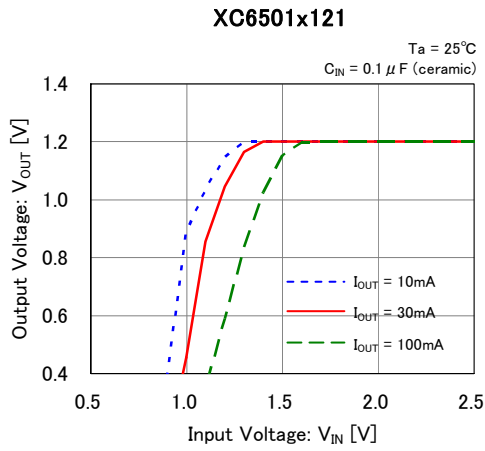

■ TYPICAL PERFORMANCE CHARACTERISTICS (Continued)

(3) Dropout Voltage vs. Output Current

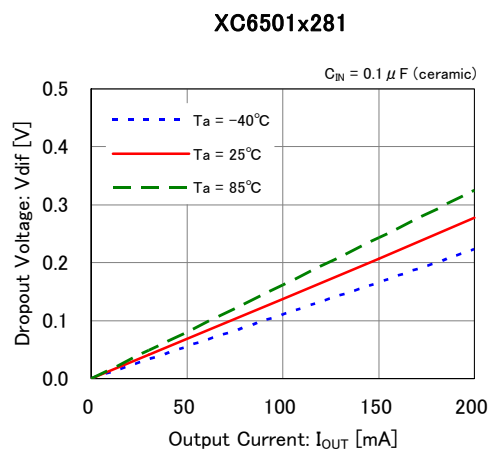
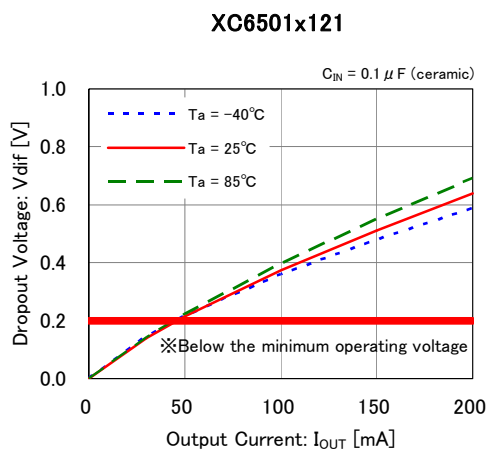

(4) Supply Current vs. Input Voltage

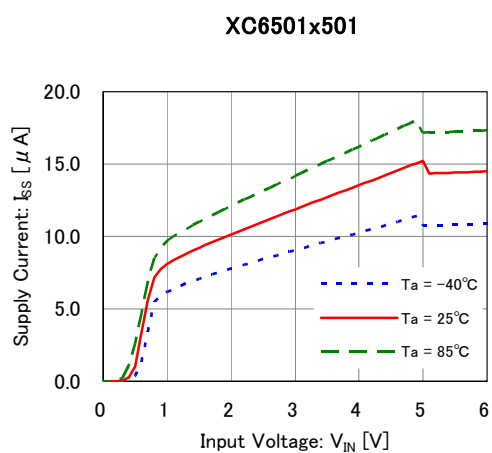
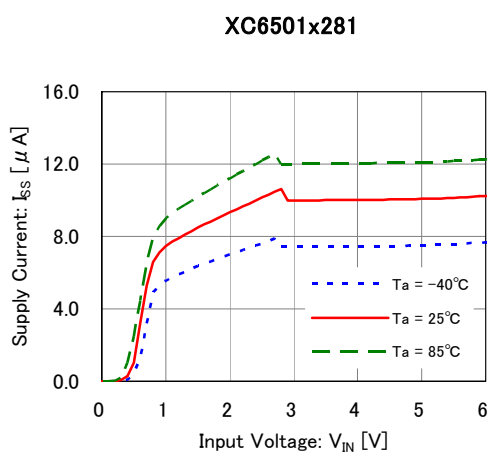
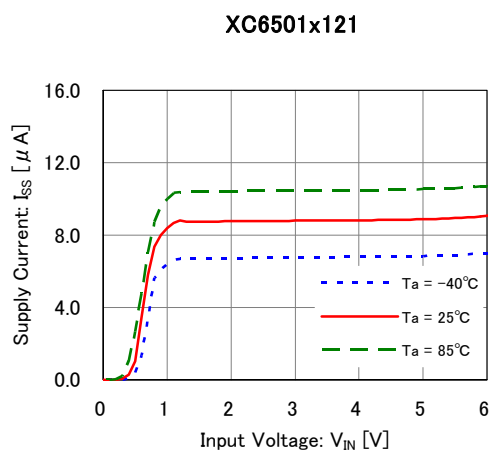
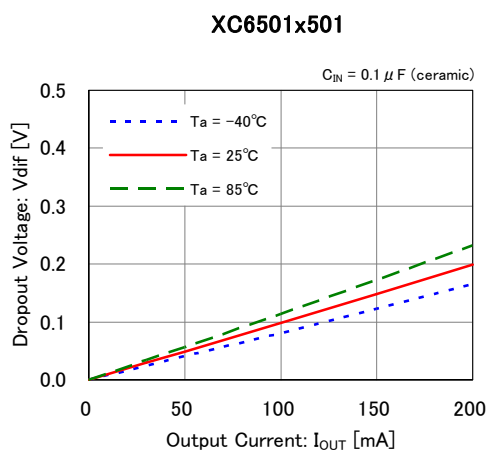

TYPICAL PERFORMANCE CHARACTERISTICS (Continued)

(5) Output Voltage vs. Ambient Temperature

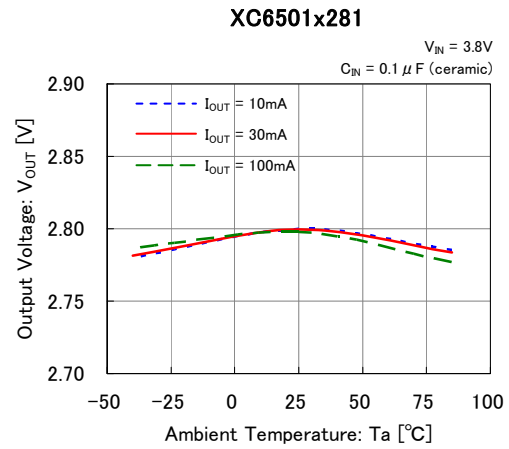
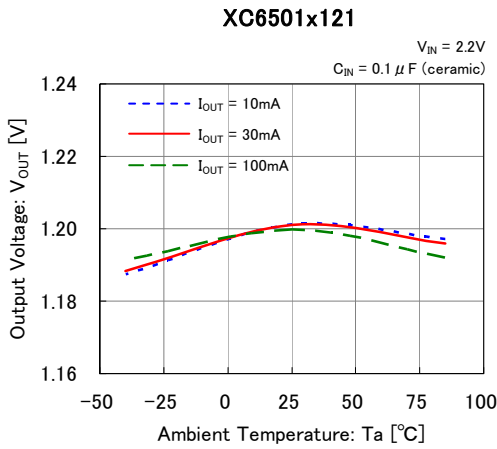

(6) Supply Current vs. Ambient Temperature

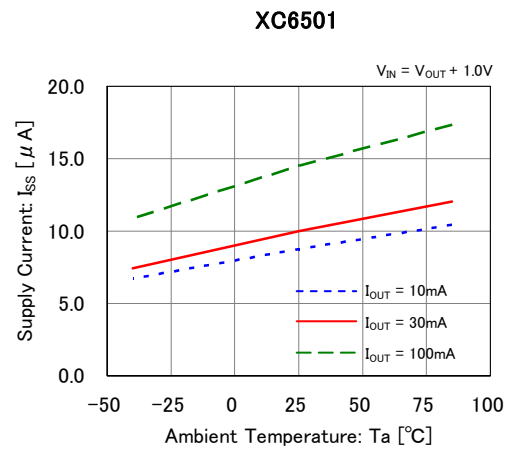
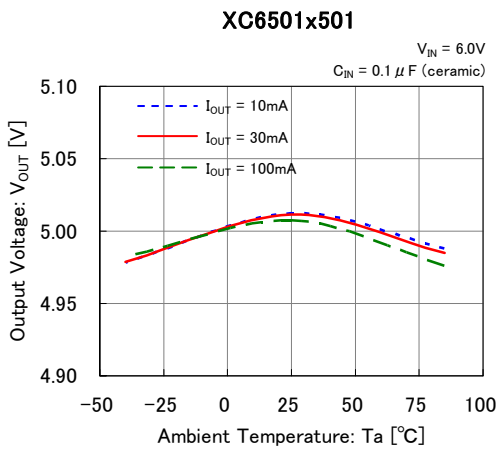

(7) CE Threshold Voltage vs. Ambient Temperature

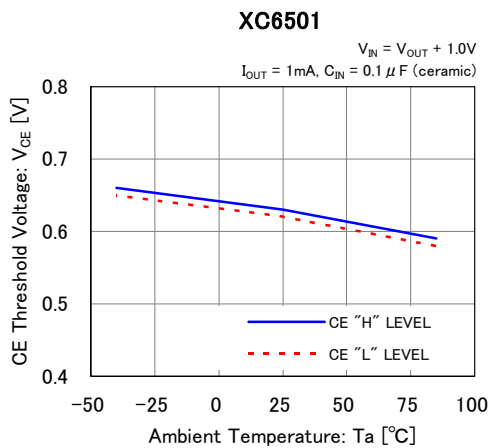

TYPICAL PERFORMANCE CHARACTERISTICS (Continued)

(8) Rising Response Time

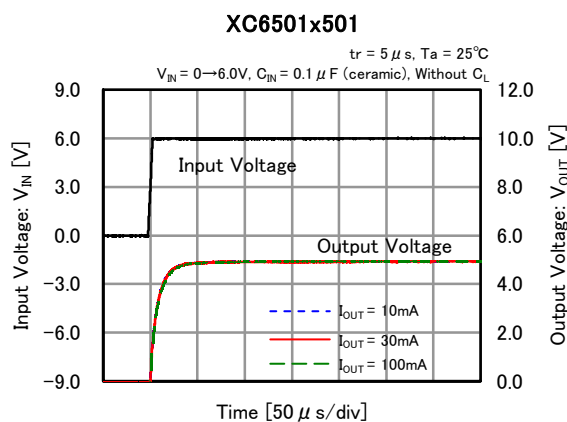
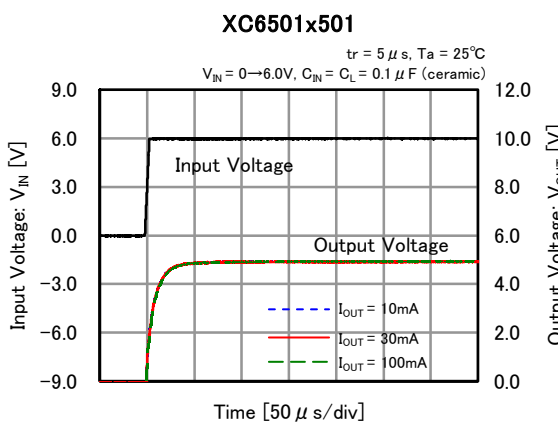
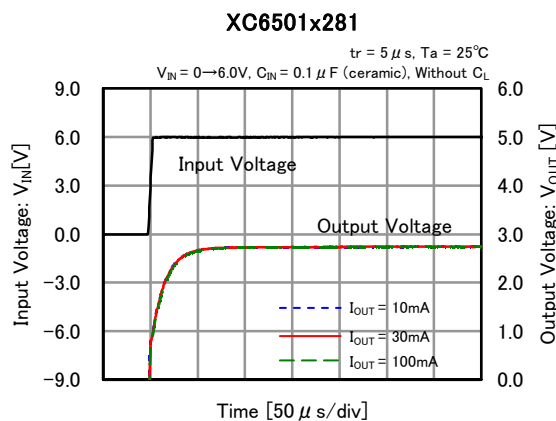
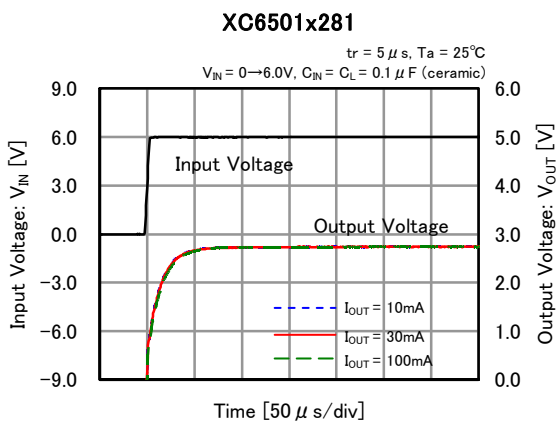
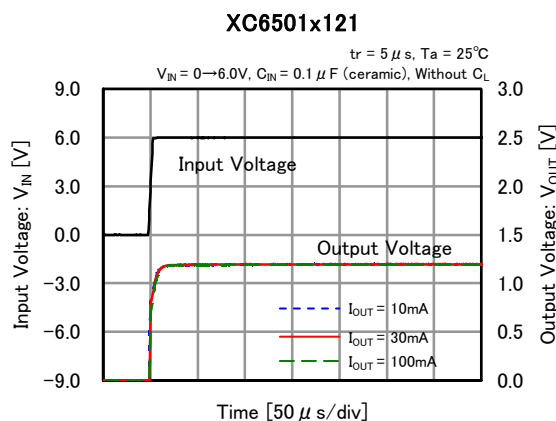
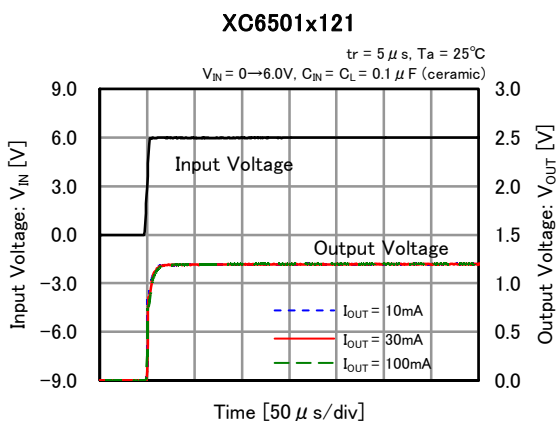

TYPICAL PERFORMANCE CHARACTERISTICS (Continued)

(9) Input Transient Response

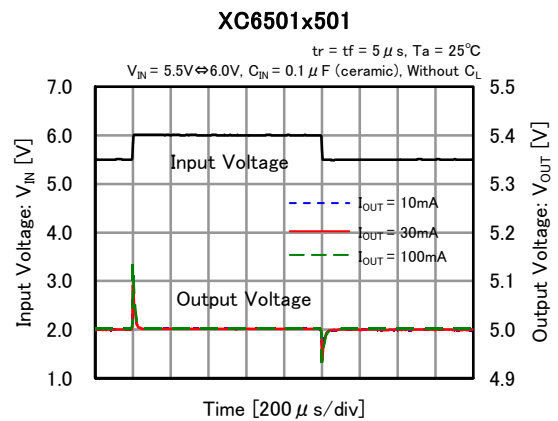
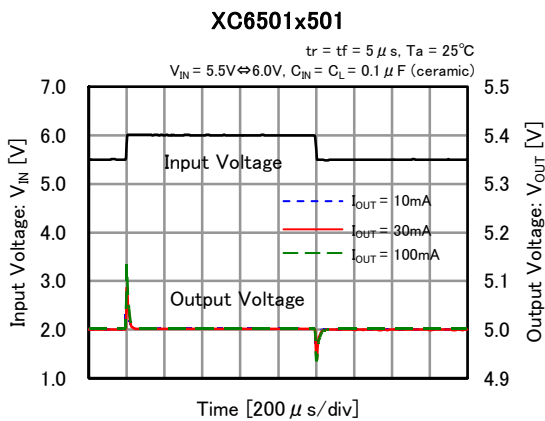
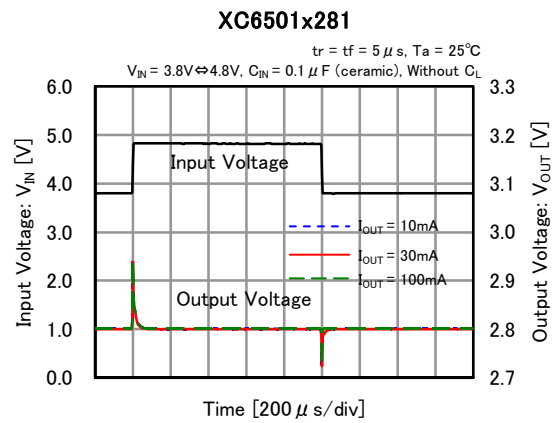
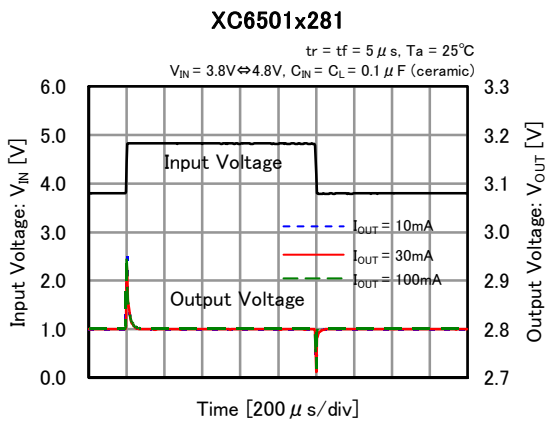
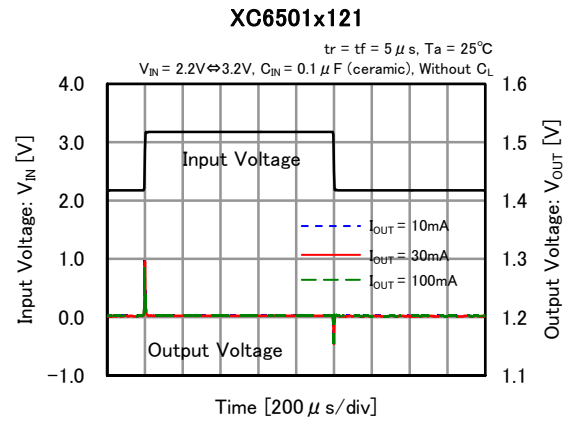
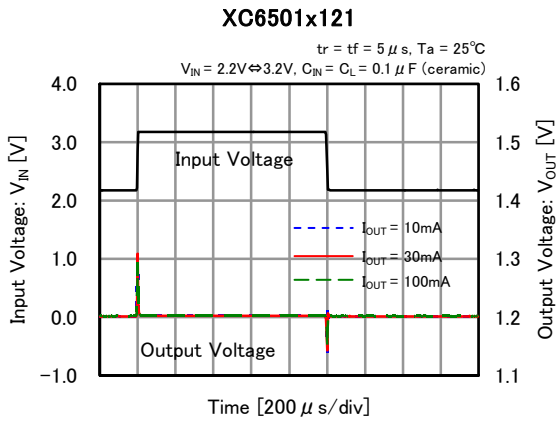

TYPICAL PERFORMANCE CHARACTERISTICS (Continued)

(10) Load Transient Response

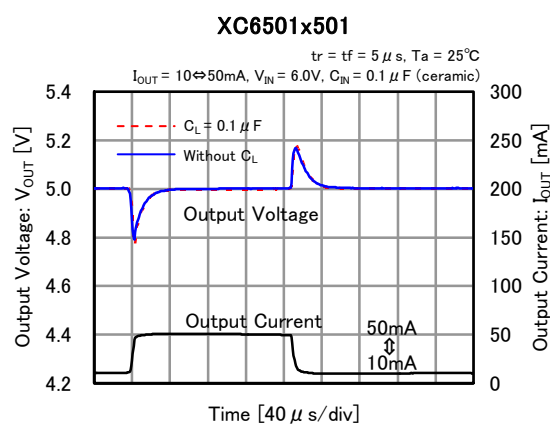
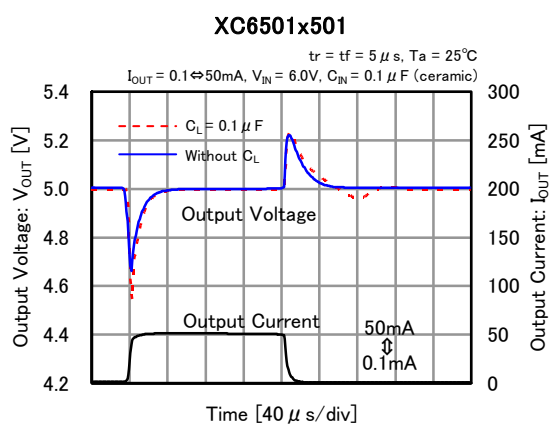
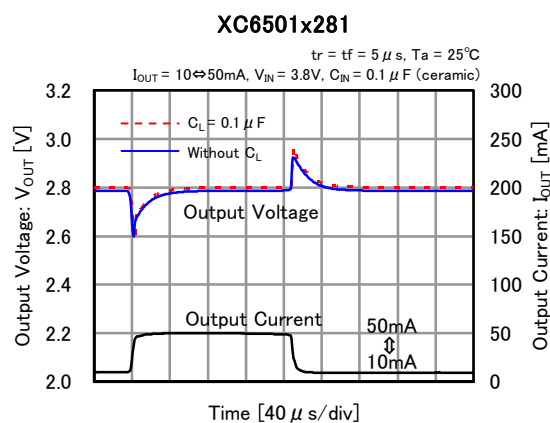
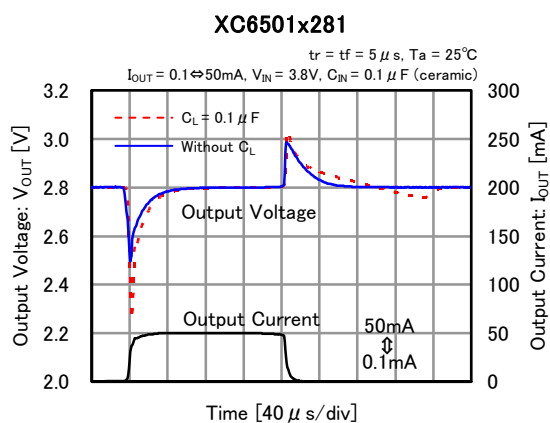
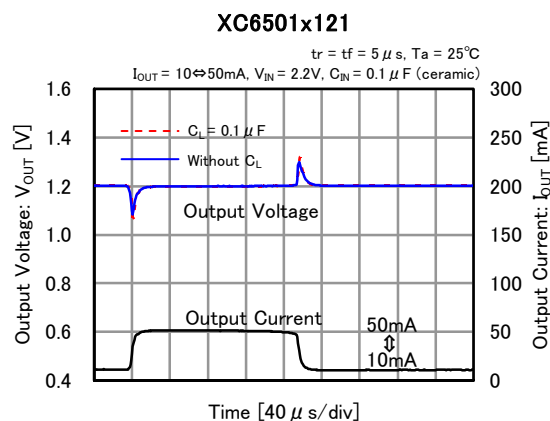
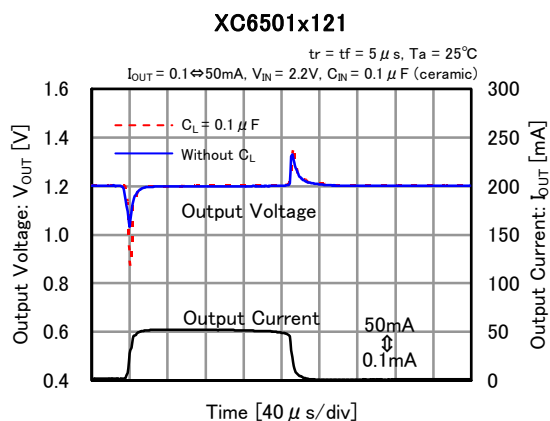

TYPICAL PERFORMANCE CHARACTERISTICS (Continued)

(11) CE Rising Respose Time

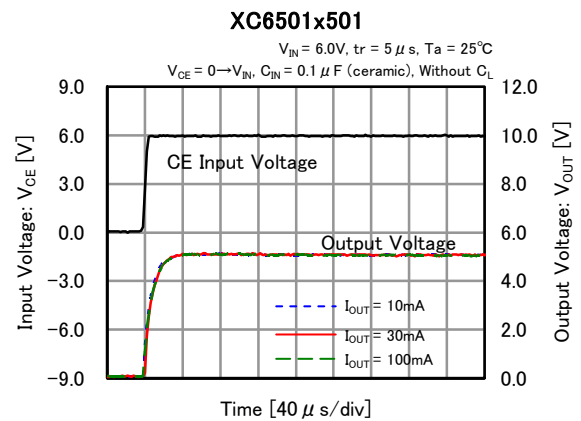
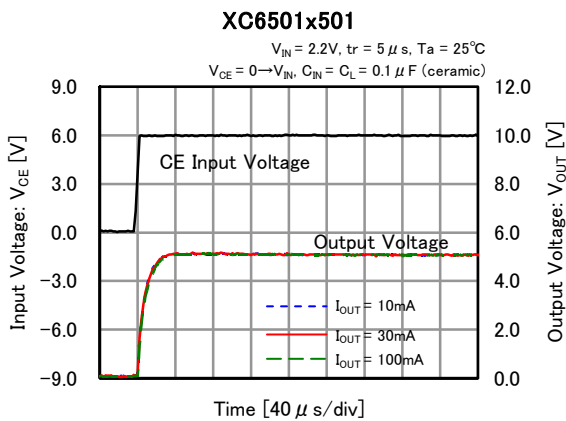
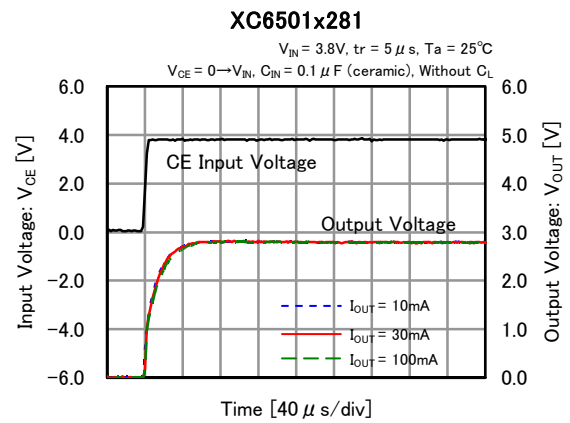
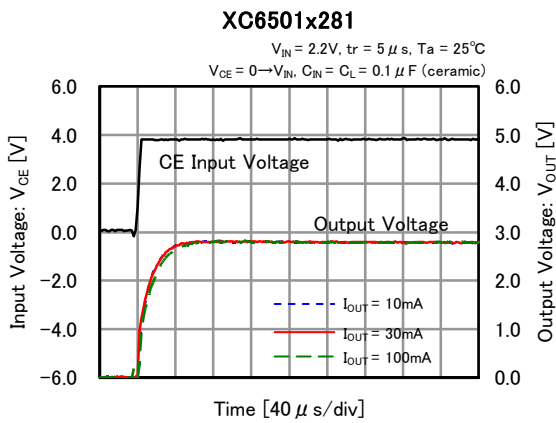
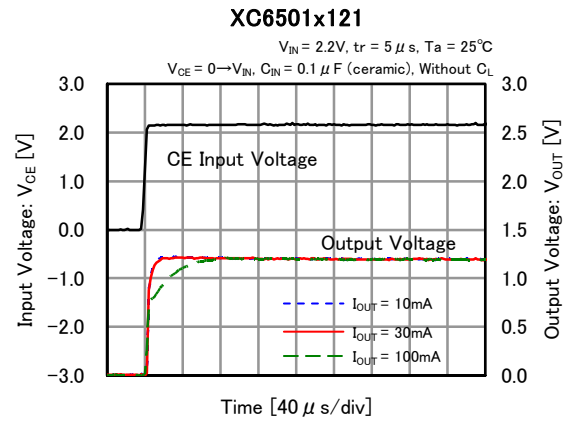
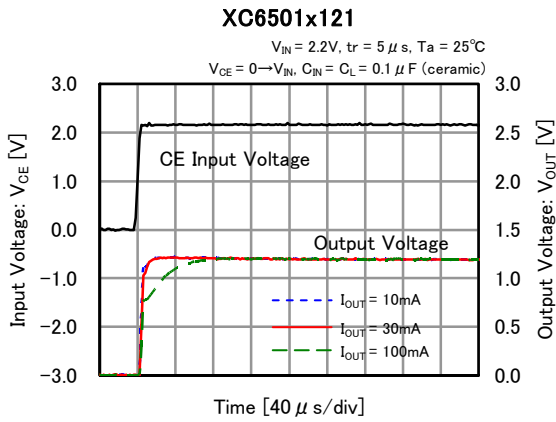

TYPICAL PERFORMANCE CHARACTERISTICS (Continued)

(12) Ripple Rejection Rate

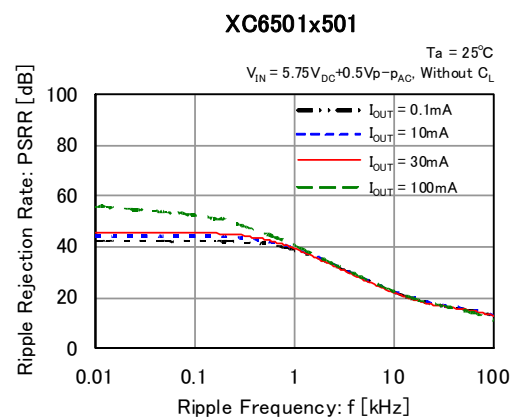
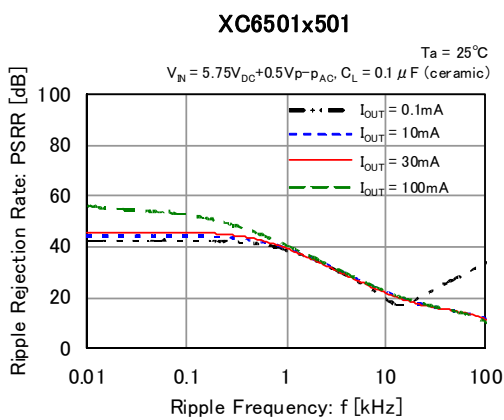
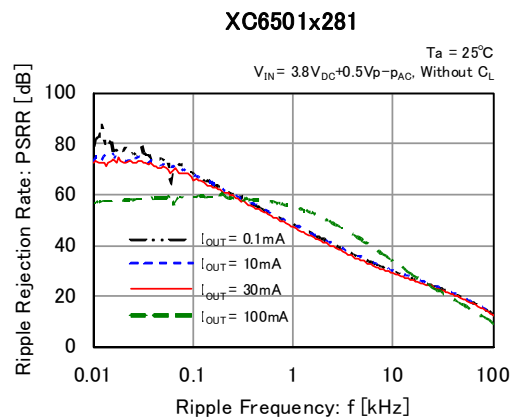
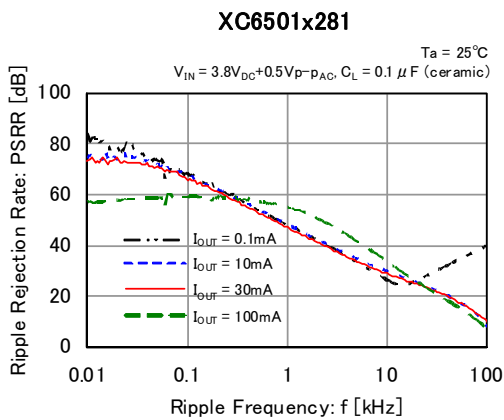
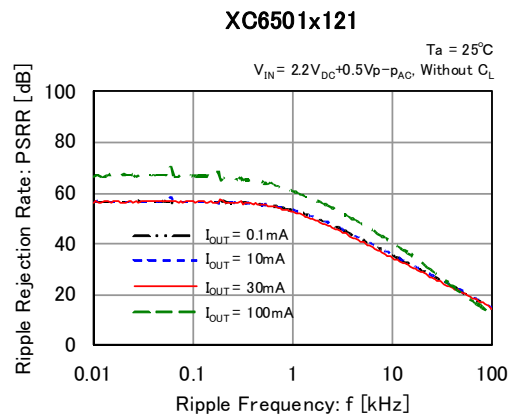
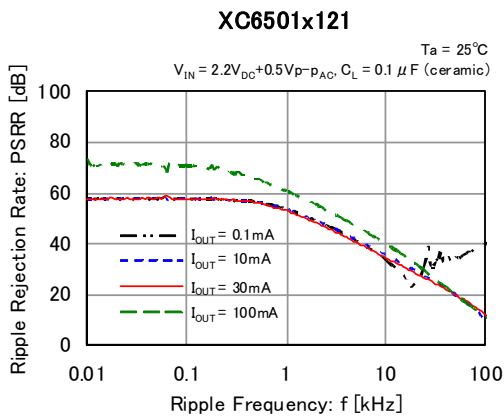

TYPICAL PERFORMANCE CHARACTERISTICS (Continued)

(13) Output Noise Density

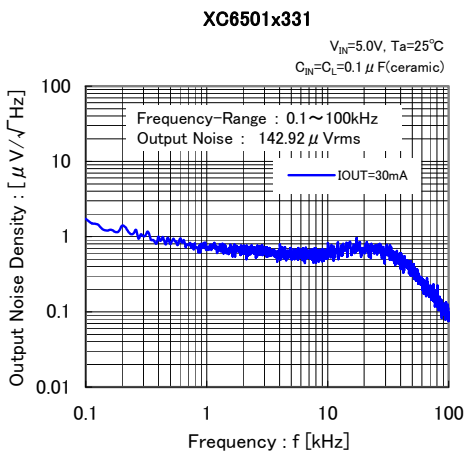
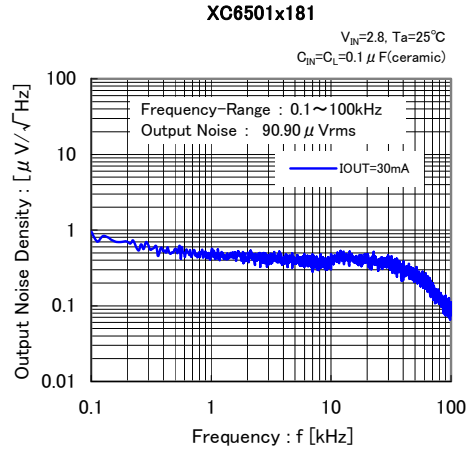
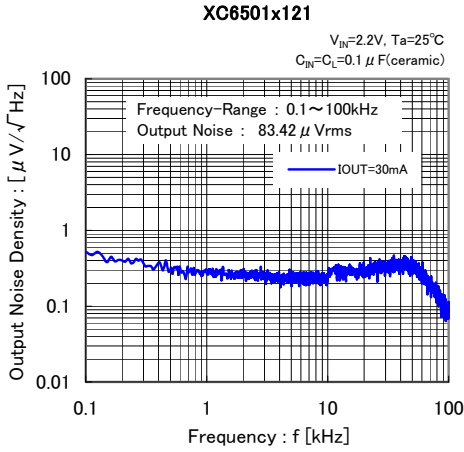

PACKAGING INFORMATION

● USP-3

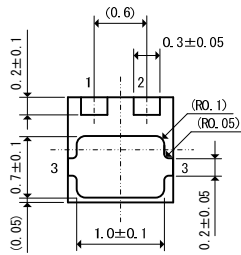
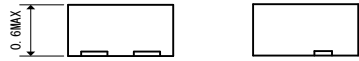
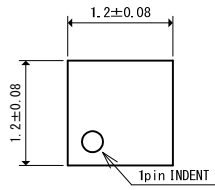

● USP-4

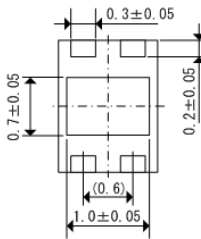
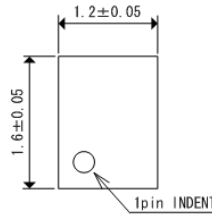

● SSOT-24

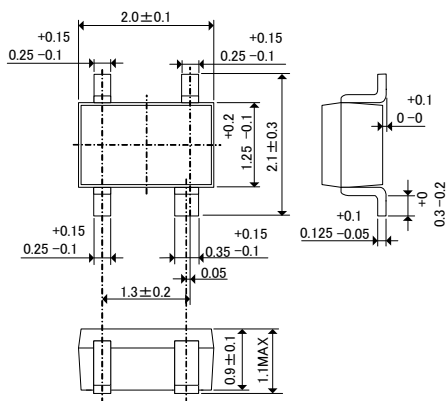

● SOT-25

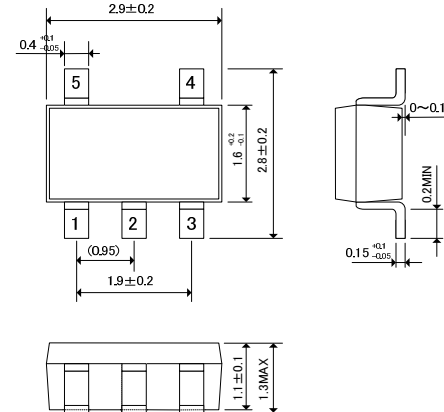

● USPN-4

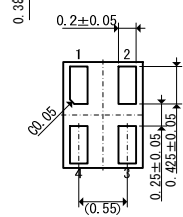
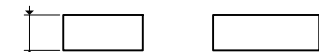
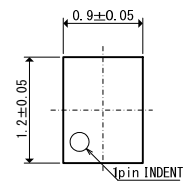

● WLP-4-01

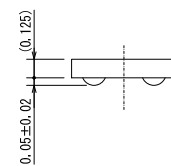
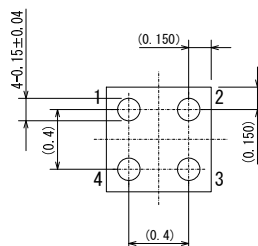
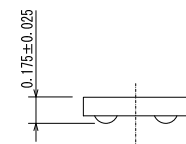
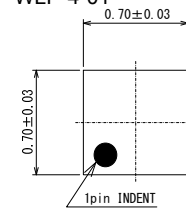

PACKAGING INFORMATION (Continued)

● USP-3 Reference Pattern Layout

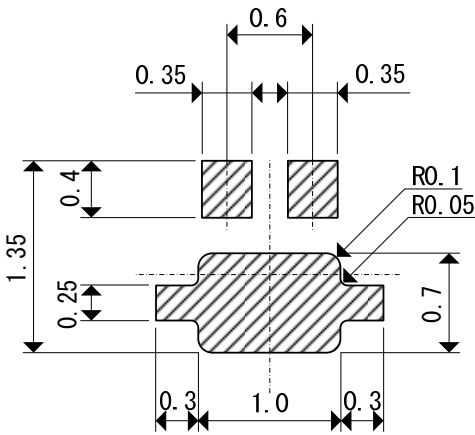

● USP-3 Reference Metal Mask Design

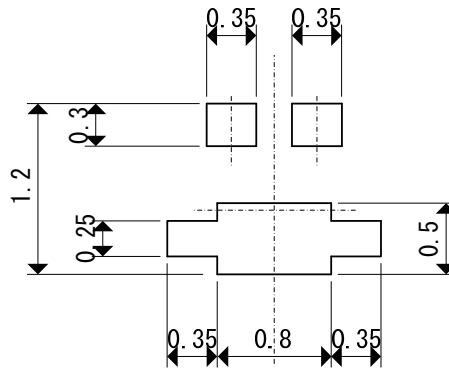

● USP-4 Reference Pattern Layout

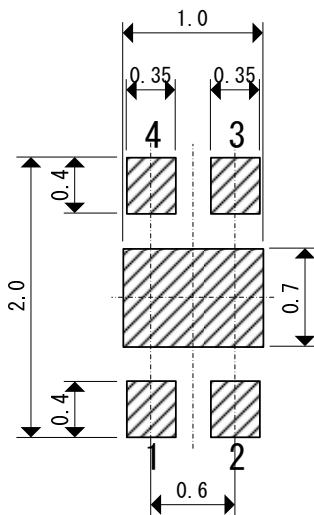

● USP-4 Reference Metal Mask Design

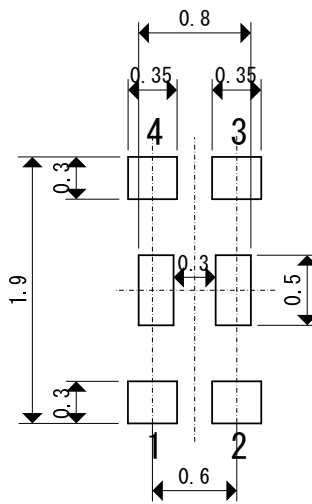

● USPN-4 Reference Pattern Layout

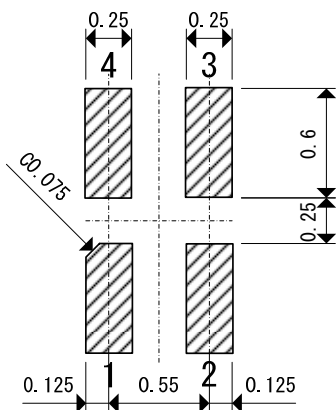

● USPN-4 Reference Metal Mask Design

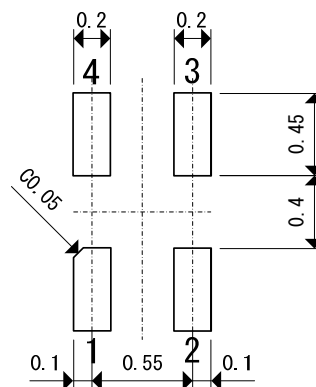

■ PACKAGING INFORMATION (Continued)

WLP-4-01 Reference
Pattern Layout

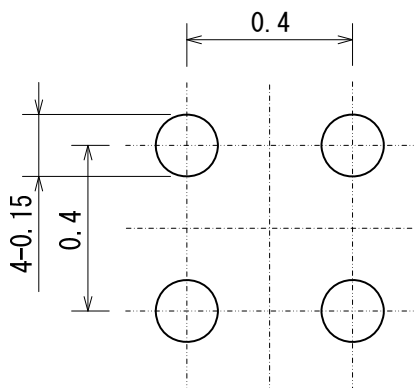

WLP-4-01 Reference
Pattern Layout detail

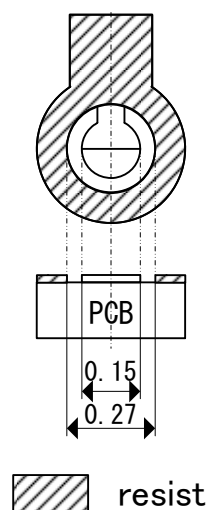

 resist

WLP-4-01 Reference
Metal Mask Design

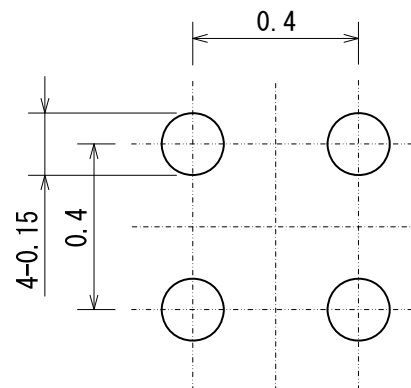

XC6501 Series

● USPN-4 Power Dissipation

Power dissipation data for the USPN-4 is shown in this page.
 The value of power dissipation varies with the mount board conditions.
 Please use this data as the reference data taken in the following condition.

1. Measurement Condition

- Condition: Mount on a board
- Ambient: Natural convection
- Soldering: Lead (Pb) free
- Board: Dimensions 40 x 40 mm (1600 mm² in one side)
 Copper (Cu) traces occupy 50% of the front and 50% of the back.
 The copper area is divided into four block,
 one block is 12.5% of total.
 The USPN-4 package has for terminals.
 Each terminal connects one copper block in the front
 and one in the back.
- Material: Glass Epoxy (FR-4)
- Thickness: 1.6 mm
- Through-hole: 4 x 0.8 Diameter

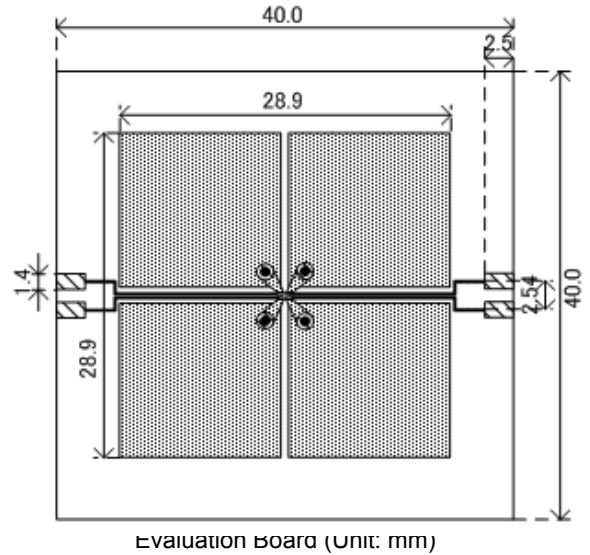

2. Power Dissipation vs. Ambient Temperature

Board Mount ($T_j \text{ max} = 125^\circ\text{C}$)

Ambient Temperature (°C)	Power Dissipation Pd (mW)	Thermal Resistance (°C/W)
25	600	166.67
105	120	

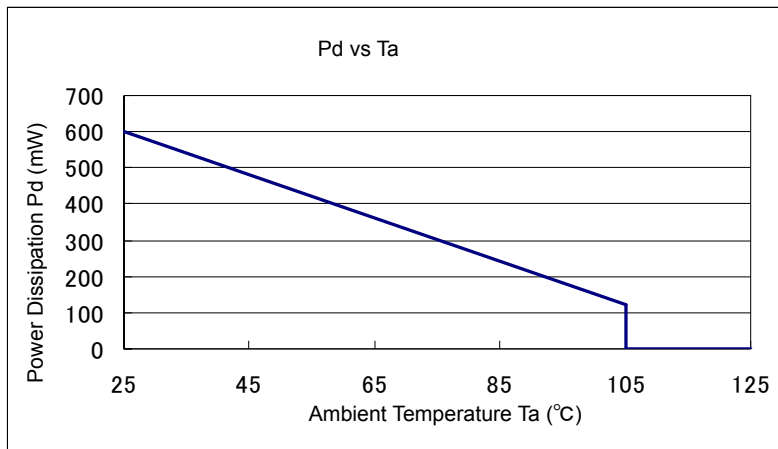

● USP-4 Power Dissipation

Power dissipation data for the USP-4 is shown in this page.
The value of power dissipation varies with the mount board conditions.
Please use this data as the reference data taken in the following condition.

1. Measurement Condition

- Condition: Mount on a board
- Ambient: Natural convection
- Soldering: Lead (Pb) free
- Board: Dimensions 40 x 40 mm (1600 mm² in one side)
Copper (Cu) traces occupy 50% of the board area
In top and back faces
Package heat-sink is tied to the copper traces
- Material: Glass Epoxy (FR-4)
- Thickness: 1.6 mm
- Through-hole: 4 x 0.8 Diameter

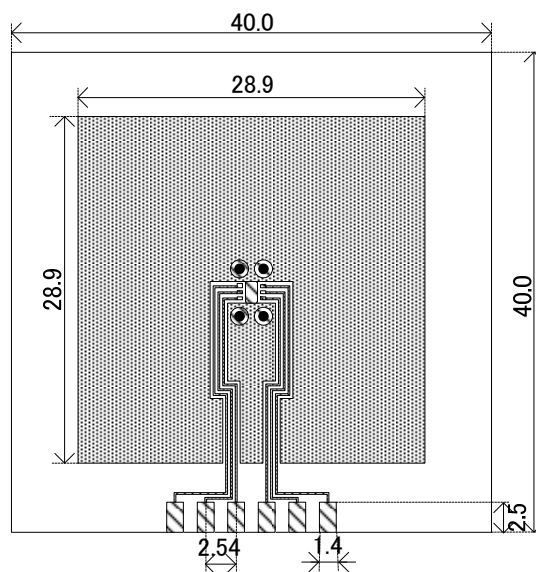

Evaluation Board (Unit: mm)

2. Power Dissipation vs. Ambient Temperature

Board Mount (T_j max = 125°C)

Ambient Temperature (°C)	Power Dissipation Pd (mW)	Thermal Resistance (°C/W)
25	1000	100.00
85	400	

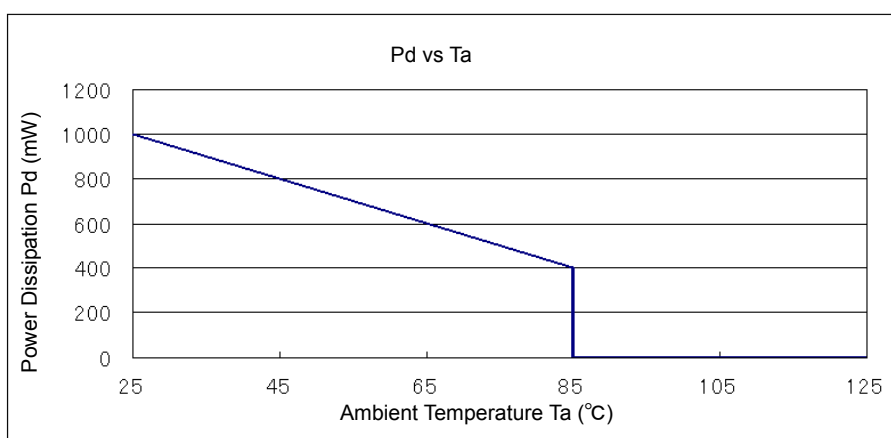

XC6501 Series

● SSOT-24 Power Dissipation

Power dissipation data for the SSOT-24 is shown in this page.
 The value of power dissipation varies with the mount board conditions.
 Please use this data as the reference data taken in the following condition.

1. Measurement Condition

- Condition: Mount on a board
- Ambient: Natural convection
- Soldering: Lead (Pb) free
- Board: Dimensions 40 x 40 mm (1600 mm² in one side)
 Copper (Cu) traces occupy 50% of the board area
 In top and back faces
 Package heat-sink is tied to the copper traces
- Material: Glass Epoxy (FR-4)
- Thickness: 1.6 mm
- Through-hole: 4 x 0.8 Diameter

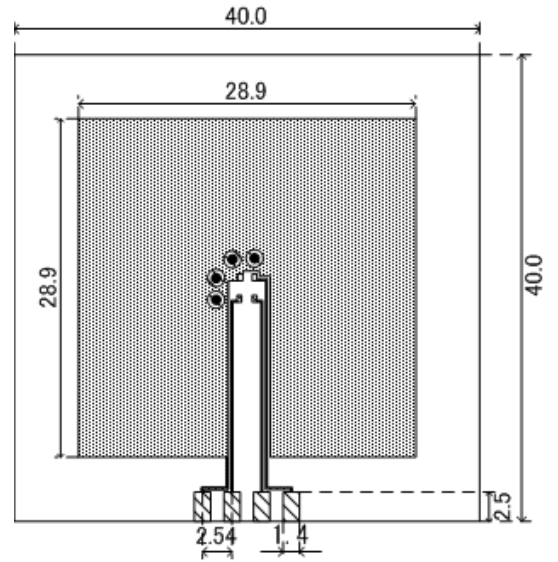

Evaluation Board (Unit: mm)

2. Power Dissipation vs. Ambient Temperature

Board Mount ($T_j \text{ max} = 125^\circ\text{C}$)

Ambient Temperature ($^\circ\text{C}$)	Power Dissipation P_d (mW)	Thermal Resistance ($^\circ\text{C}/\text{W}$)
25	500	200.00
85	200	

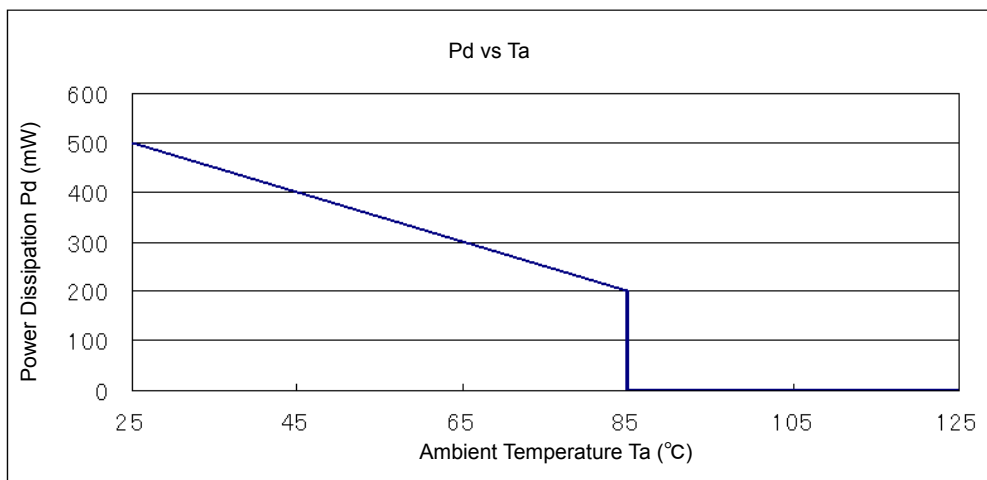

● SOT-25 Power Dissipation

Power dissipation data for the SOT-25 is shown in this page.
The value of power dissipation varies with the mount board conditions.
Please use this data as the reference data taken in the following condition.

1. Measurement Condition

- Condition: Mount on a board
- Ambient: Natural convection
- Soldering: Lead (Pb) free
- Board: Dimensions 40 x 40 mm (1600 mm² in one side)
Copper (Cu) traces occupy 50% of the board area
In top and back faces
Package heat-sink is tied to the copper traces
(Board of SOT-26 is used.)
- Material: Glass Epoxy (FR-4)
- Thickness: 1.6 mm
- Through-hole: 4 x 0.8 Diameter

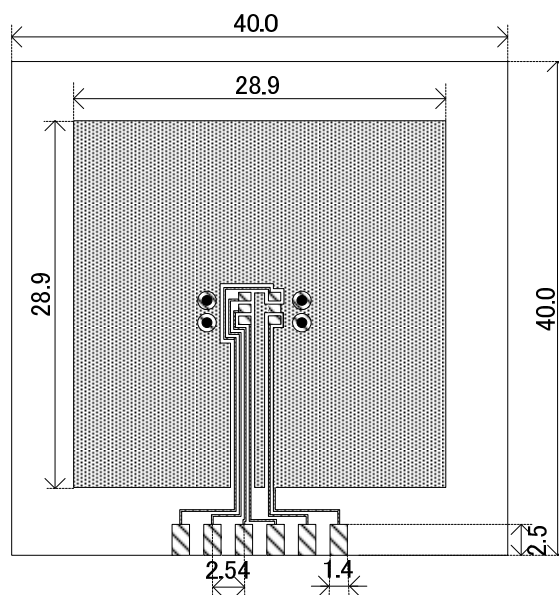

Evaluation Board (Unit: mm)

2. Power Dissipation vs. Ambient Temperature

Board Mount ($T_j \text{ max} = 125^\circ\text{C}$)

Ambient Temperature (°C)	Power Dissipation Pd (mW)	Thermal Resistance (°C/W)
25	600	166.67
85	240	

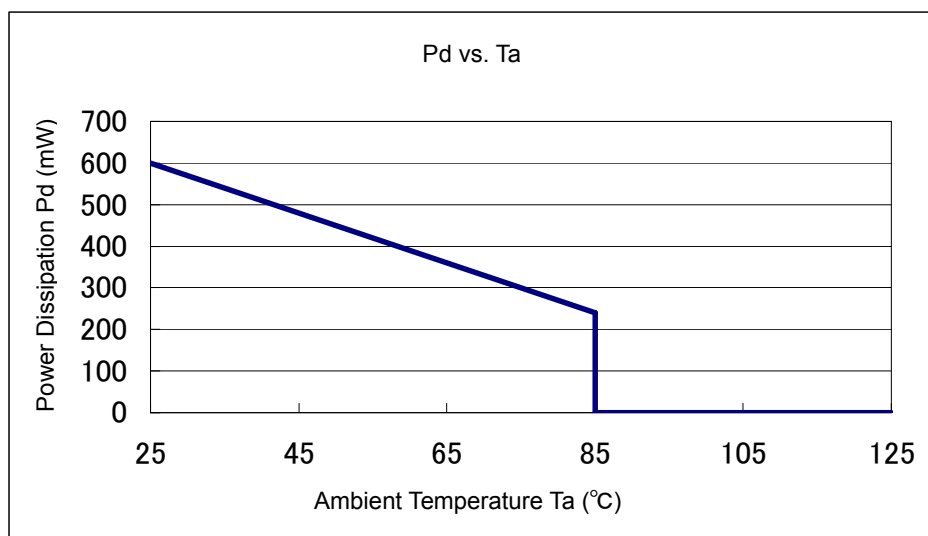

XC6501 Series

● USP-3 Power Dissipation

Power dissipation data for the USP-3 is shown in this page.

The value of power dissipation varies with the mount board conditions.

Please use this data as the reference data taken in the following condition.

1. Measurement Condition

Condition: Mount on a board

Ambient: Natural convection

Soldering: Lead (Pb) free

Board: Dimensions 40 x 40 mm
(1600 mm² in one side)
Copper (Cu) traces occupy 50% of the board area

In top and back faces

Package heat-sink is tied to the copper traces

Material: Glass Epoxy (FR-4)

Thickness: 1.6 mm

Through-hole: 4 x 0.8 Diameter

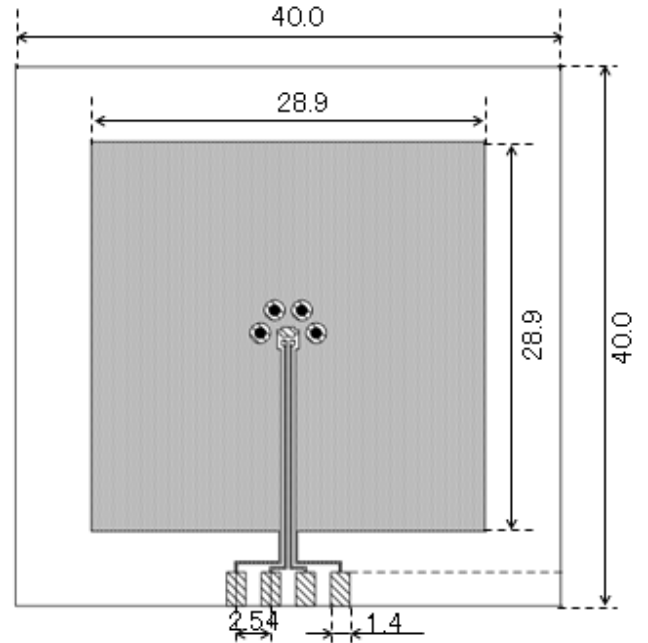

Evaluation Board (Unit: mm)

2. Power Dissipation vs. Ambient Temperature

Board Mount (T_j max = 125°C)

Ambient Temperature (°C)	Power Dissipation Pd (mW)	Thermal Resistance (°C/W)
25	1000	100.00
85	400	

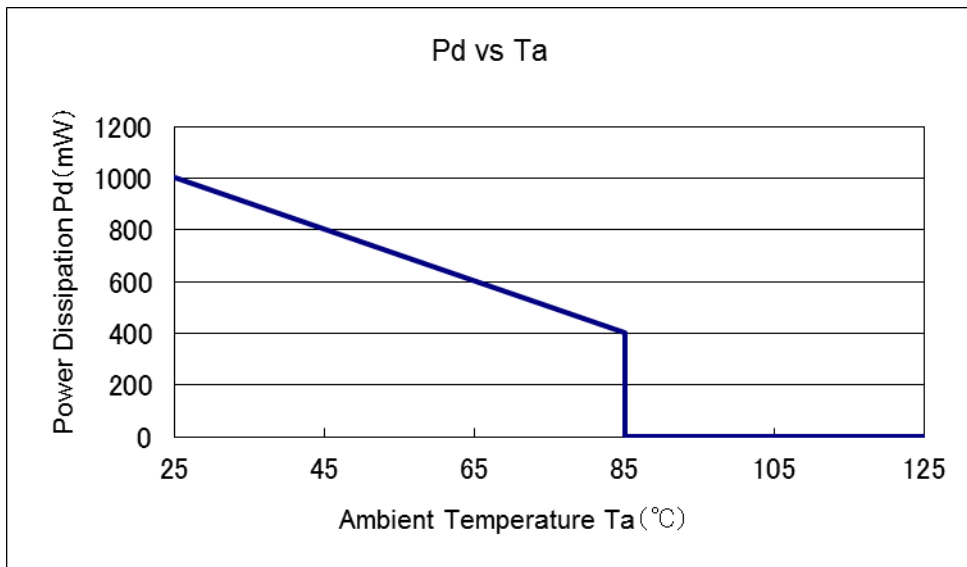

● WLP-4-01 Power Dissipation

Power dissipation data for the WLP-4-01 is shown in this page.

The value of power dissipation varies with the mount board conditions.

Please use this data as the reference data taken in the following condition.

2. Measurement Condition

- Condition : Mount on a board
- Ambient : Natural convection
- Soldering : Lead (Pb) free
- Board Dimensions : 40 x 40 mm (1600mm²)
- Board Structure : 1st Meter layer about 50%
- 2nd Inner Metal layer about 50%
- 3rd Inner Metal layer about 50%
- 4th Metal layer about 50%
- 4 separations is each layer connected to each pin
- Material : Glass Epoxy (FR-4)
- Thickness : 1.6 mm
- Through-hole : 4 x 0.8 Diameter

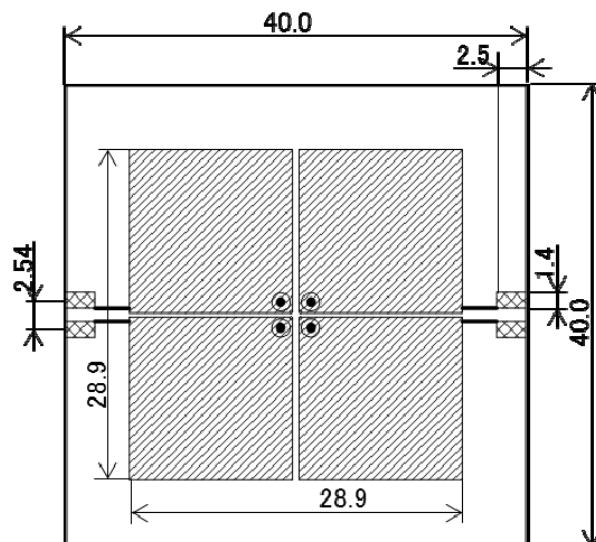

2. Power Dissipation vs. Ambient Temperature

Board Mount (T_j max = 125°C)

Ambient Temperature (°C)	Power Dissipation Pd (mW)	Thermal Resistance (°C/W)
25	660	151.52
85	264	

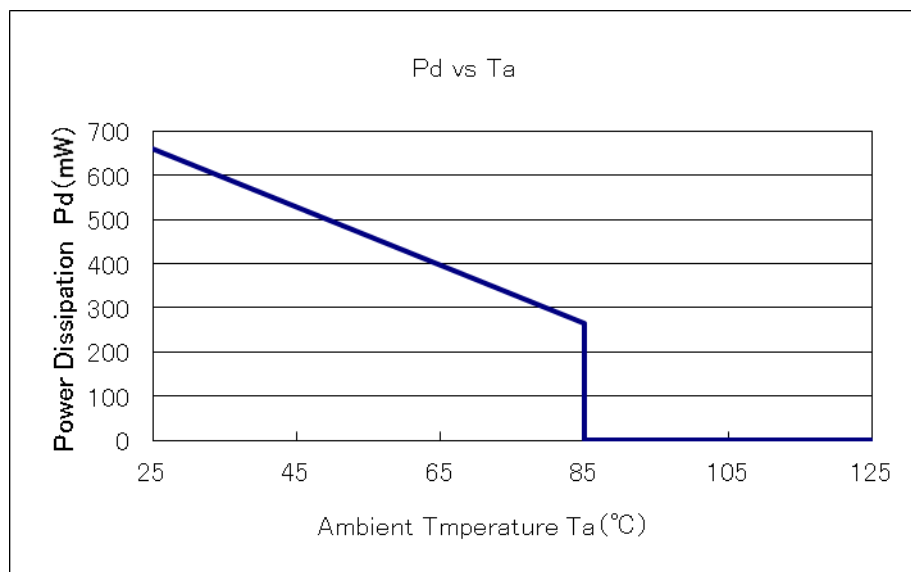

XC6501 Series

MARKING RULE

SOT-25

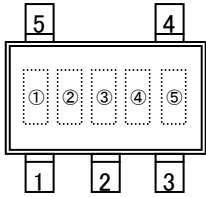

USP-4

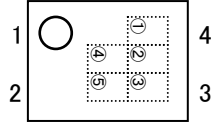

USP-3

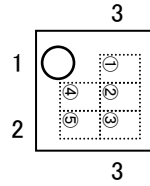

USPN-4

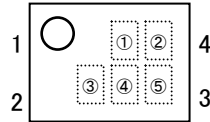

SOT-25/USP-4/USP-3/USPN-4

① represents product series

MARK	PRODUCT SERIES
A	XC6501*****

② represents type of regulator

MARK				PRODUCT SERIES
OUTPUT VOLTAGE 0.1V INCREMENTS		OUTPUT VOLTAGE 0.05V INCREMENTS		
VOLTAGE= 1.2~3.0V	VOLTAGE= 3.1~5.0V	VOLTAGE= 1.25~3.05V	VOLTAGE= 3.15~4.95V	
U	A	E	M	XC6501A*****
V	B	F	N	XC6501B*****
X	C	H	R	XC6501C*****
Y	D	K	S	XC6501D*****
Z	P	L	T	XC6501P*****

③ represents type of output voltage range

MARK	OUTPUT VOLTAGE (V)				MARK	OUTPUT VOLTAGE (V)			
0	-	3.10	-	3.15	F	1.60	4.60	1.65	4.65
1	-	3.20	-	3.25	H	1.70	4.70	1.75	4.75
2	-	3.30	-	3.35	K	1.80	4.80	1.85	4.85
3	-	3.40	-	3.45	L	1.90	4.90	1.95	4.95
4	-	3.50	-	3.55	M	2.00	5.00	2.05	-
5	-	3.60	-	3.65	N	2.10	-	2.15	-
6	-	3.70	-	3.75	P	2.20	-	2.25	-
7	-	3.80	-	3.85	R	2.30	-	2.35	-
8	-	3.90	-	3.95	S	2.40	-	2.45	-
9	-	4.00	-	4.05	T	2.50	-	2.55	-
A	-	4.10	-	4.15	U	2.60	-	2.65	-
B	1.20	4.20	1.25	4.25	V	2.70	-	2.75	-
C	1.30	4.30	1.35	4.35	X	2.80	-	2.85	-
D	1.40	4.40	1.45	4.45	Y	2.90	-	2.95	-
E	1.50	4.50	1.55	4.55	Z	3.00	-	3.05	-

④,⑤ represents production lot number

01 to 09, 0A to 0Z, 11 to 9Z, A1 to A9, AA to Z9, ZA to ZZ repeated.

G, I, J, O, Q, W excepted.

*No character inversion used.

■ MARKING RULE (Continued)

SSOT-24

WLP-4-01

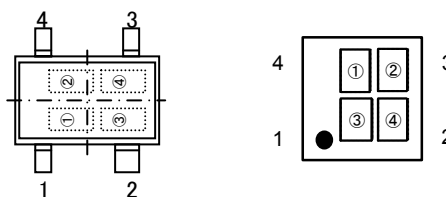

■ SSOT-24/WLP-4-01

① represents type of regulator

MARK				PRODUCT SERIES
VOLTAGE= 1.2~2.15V	VOLTAGE= 2.2~3.15V	VOLTAGE= 3.2~4.15V	VOLTAGE= 4.2~5.0V	
5	6	7	8	XC6501A*****
D	E	F	H	XC6501B*****
R	S	T	0	XC6501C*****
V	X	Y	Z	XC6501D*****

② represents type of output voltage range

MARK	OUTPUT VOLTAGE (V)				MARK	OUTPUT VOLTAGE (V)			
A	1.20	2.20	3.20	4.20	N	1.70	2.70	3.70	4.70
B	1.25	2.25	3.25	4.25	P	1.75	2.75	3.75	4.75
C	1.30	2.30	3.30	4.30	R	1.80	2.80	3.80	4.80
D	1.35	2.35	3.35	4.35	S	1.85	2.85	3.85	4.85
E	1.40	2.40	3.40	4.40	T	1.90	2.90	3.90	4.90
F	1.45	2.45	3.45	4.45	U	1.95	2.95	3.95	4.95
H	1.50	2.50	3.50	4.50	V	2.00	3.00	4.00	5.00
K	1.55	2.55	3.55	4.55	X	2.05	3.05	4.05	-
L	1.60	2.60	3.60	4.60	Y	2.10	3.10	4.10	-
M	1.65	2.65	3.65	4.65	Z	2.15	3.15	4.15	-

③,④ represents production lot number

01 to 09, 0A to 0Z, 11 to 9Z, A1 to A9, AA to Z9, ZA to ZZ repeated.

G, I, J, O, Q, W excepted.

*No character inversion used.

1. The product and product specifications contained herein are subject to change without notice to improve performance characteristics. Consult us, or our representatives before use, to confirm that the information in this datasheet is up to date.
2. The information in this datasheet is intended to illustrate the operation and characteristics of our products. We neither make warranties or representations with respect to the accuracy or completeness of the information contained in this datasheet nor grant any license to any intellectual property rights of ours or any third party concerning with the information in this datasheet.
3. Applicable export control laws and regulations should be complied and the procedures required by such laws and regulations should also be followed, when the product or any information contained in this datasheet is exported.
4. The product is neither intended nor warranted for use in equipment of systems which require extremely high levels of quality and/or reliability and/or a malfunction or failure which may cause loss of human life, bodily injury, serious property damage including but not limited to devices or equipment used in 1) nuclear facilities, 2) aerospace industry, 3) medical facilities, 4) automobile industry and other transportation industry and 5) safety devices and safety equipment to control combustions and explosions. Do not use the product for the above use unless agreed by us in writing in advance.
5. Although we make continuous efforts to improve the quality and reliability of our products; nevertheless Semiconductors are likely to fail with a certain probability. So in order to prevent personal injury and/or property damage resulting from such failure, customers are required to incorporate adequate safety measures in their designs, such as system fail safes, redundancy and fire prevention features.
6. Our products are not designed to be Radiation-resistant.
7. Please use the product listed in this datasheet within the specified ranges.
8. We assume no responsibility for damage or loss due to abnormal use.
9. All rights reserved. No part of this datasheet may be copied or reproduced unless agreed by Torex Semiconductor Ltd in writing in advance.

TOREX SEMICONDUCTOR LTD.

Mouser Electronics

Authorized Distributor

Click to View Pricing, Inventory, Delivery & Lifecycle Information:

Torex Semiconductor:

[XC6501A181MR-G](#) [XC6501A3017R-G](#) [XC6501D18AGR-G](#) [XC6501B281MR-G](#) [XC6501A251NR-G](#)
[XC6501B331GR-G](#) [XC6501B301MR-G](#) [XC6501B271MR-G](#) [XC6501D151NR-G](#) [XC6501D301MR-G](#)
[XC6501B191NR-G](#) [XC6501A291NR-G](#) [XC6501D2817R-G](#) [XC6501D181MR-G](#) [XC6501D261GR-G](#) [XC6501A31A7R-G](#)
[XC6501B121MR-G](#) [XC6501A191NR-G](#) [XC6501B181MR-G](#) [XC6501B121NR-G](#) [XC6501D121GR-G](#)
[XC6501A181NR-G](#) [XC6501B301GR-G](#) [XC6501D281NR-G](#) [XC6501P251HR-G](#) [XC6501P311HR-G](#) [XC6501A331NR-G](#)
[XC6501B251GR-G](#) [XC6501D3417R-G](#) [XC6501A201MR-G](#) [XC6501A321NR-G](#) [XC6501B181GR-G](#)
[XC6501B251NR-G](#) [XC6501B2817R-G](#) [XC6501D301GR-G](#) [XC6501D331NR-G](#) [XC6501A261NR-G](#) [XC6501D28A7R-G](#)
[XC6501P121HR-G](#) [XC6501A121MR-G](#) [XC6501A281NR-G](#) [XC6501A181GR-G](#) [XC6501B281NR-G](#)
[XC6501A211MR-G](#) [XC6501A31AMR-G](#) [XC6501A361MR-G](#) [XC6501D1517R-G](#) [XC6501B3317R-G](#) [XC6501D1217R-G](#)
[XC6501P321HR-G](#) [XC6501D301NR-G](#) [XC6501A301GR-G](#) [XC6501A301MR-G](#) [XC6501A331MR-G](#)
[XC6501B1217R-G](#) [XC6501D321GR-G](#) [XC6501D331MR-G](#) [XC6501A221MR-G](#) [XC6501A2817R-G](#) [XC6501D281GR-G](#)
[XC6501D3217R-G](#) [XC6501B371MR-G](#) [XC6501B5017R-G](#) [XC6501D181GR-G](#) [XC6501D291NR-G](#)
[XC6501D3317R-G](#) [XC6501B151GR-G](#) [XC6501C361MR-G](#) [XC6501A3317R-G](#) [XC6501B151NR-G](#) [XC6501D121MR-G](#)
[XC6501A331GR-G](#) [XC6501B251MR-G](#) [XC6501D1817R-G](#) [XC6501D3017R-G](#) [XC6501D2617R-G](#)
[XC6501P291HR-G](#) [XC6501A301NR-G](#) [XC6501D331GR-G](#) [XC6501B151MR-G](#) [XC6501B401MR-G](#) [XC6501D121NR-G](#)
[XC6501A151MR-G](#) [XC6501A281MR-G](#) [XC6501B331MR-G](#) [XC6501A231MR-G](#)