

Single Phase Glass Passivated Silicon Bridge Rectifier

$V_{RRM} = 50\text{ V} - 400\text{ V}$

$I_O = 4\text{ A}$

Features

- Ideal for printed circuit board
- Reliable low cost construction
- Plastic material has Underwriters Laboratory Flammability Classification 94V-0
- Surge overload rating to 120 Amperes peak
- Types from 50 V to 400 V V_{RRM}
- Not ESD Sensitive

Mechanical Data

Case: Molded plastic

Weight: 0.15 ounce, 4.0 grams

Mounting torque: 5 inch-lb max

KBJ Package

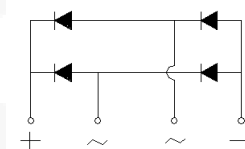

Maximum ratings at $T_j = 25\text{ }^\circ\text{C}$, unless otherwise specified

Parameter	Symbol	Conditions	KBJ4005G	KBJ401G	KBJ402G	KBJ404G	Unit
Repetitive peak reverse voltage	V_{RRM}		50	100	200	400	V
RMS reverse voltage	V_{RMS}		35	70	140	280	V
DC blocking voltage	V_{DC}		50	100	200	400	V
Operating temperature	T_j		-55 to 150	-55 to 150	-55 to 150	-55 to 150	$^\circ\text{C}$
Storage temperature	T_{stg}		-55 to 150	-55 to 150	-55 to 150	-55 to 150	$^\circ\text{C}$

Electrical characteristics at $T_j = 25\text{ }^\circ\text{C}$, unless otherwise specified

Single phase, half sine wave, 60 Hz, resistive or inductive load

For capacitive load derate current by 20%

Parameter	Symbol	Conditions	KBJ4005G	KBJ401G	KBJ402G	KBJ404G	Unit
Maximum average forward rectified current	I_O	$T_c = 108\text{ }^\circ\text{C}$	4	4	4	4	A
		$T_a = 25\text{ }^\circ\text{C}$	2.3	2.3	2.3	2.3	
Peak forward surge current	I_{FSM}	8.3 ms single sine-wave	120	120	120	120	A
Maximum instantaneous forward voltage per leg	V_F	$I_F = 4\text{ A}$	1.1	1.1	1.1	1.1	V
Maximum reverse current at rated DC blocking voltage per leg	I_R	$T_a = 25\text{ }^\circ\text{C}$	5	5	5	5	μA
		$T_a = 125\text{ }^\circ\text{C}$	500	500	500	500	

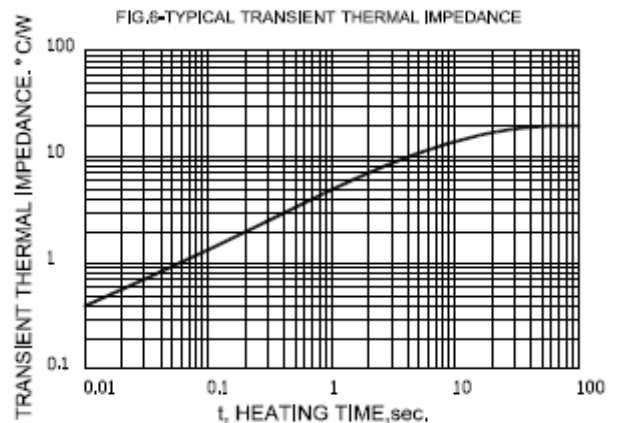
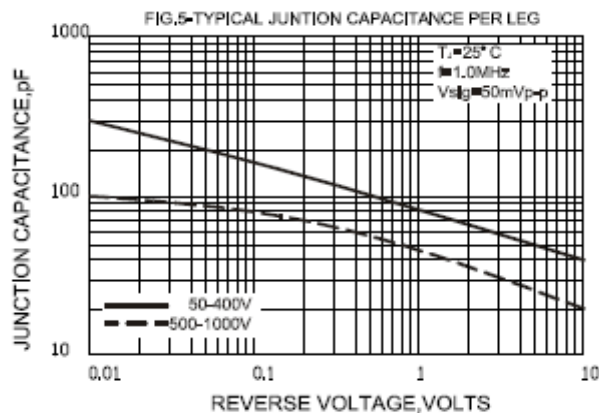
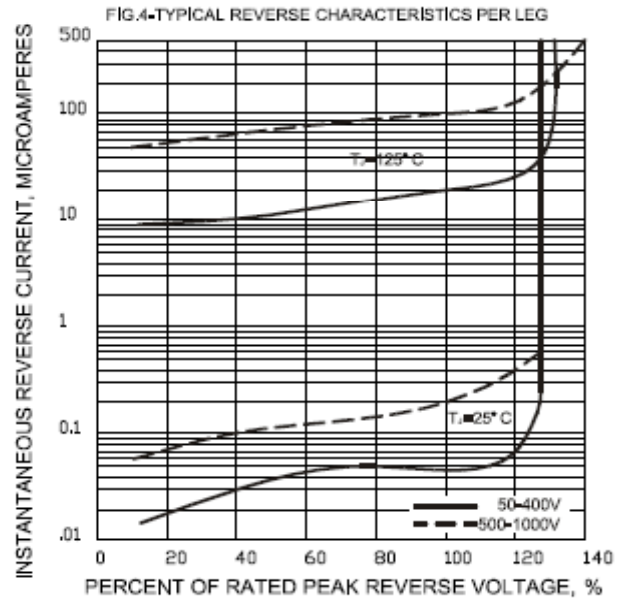
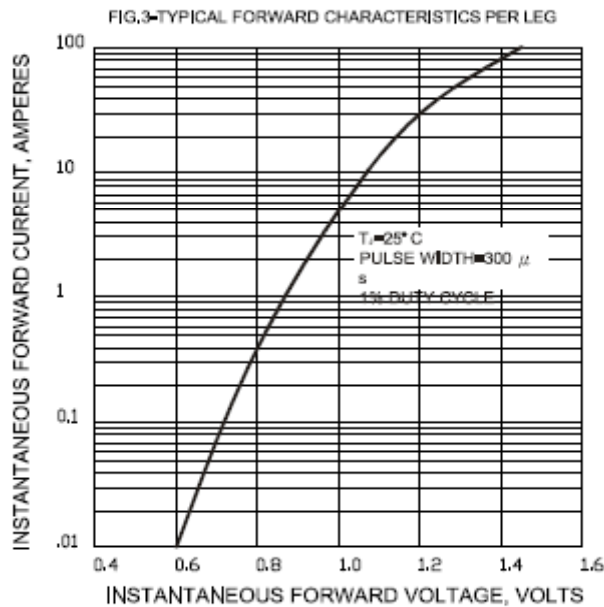
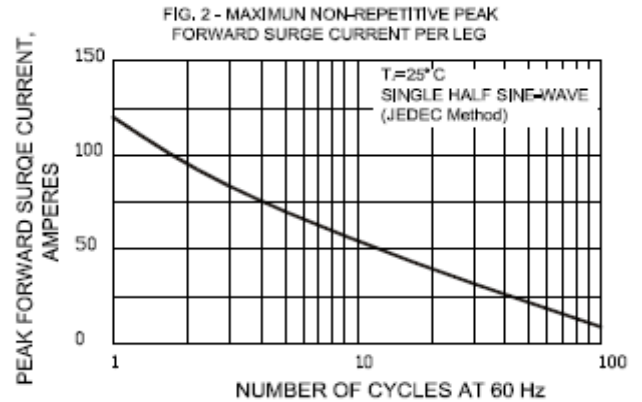
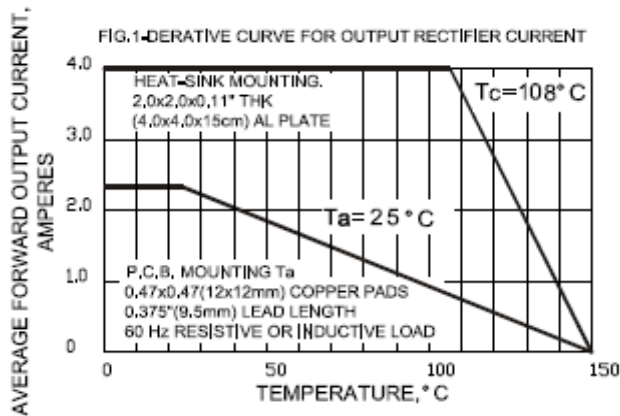

Package dimensions and terminal configuration

Product is marked with part number and terminal configuration.

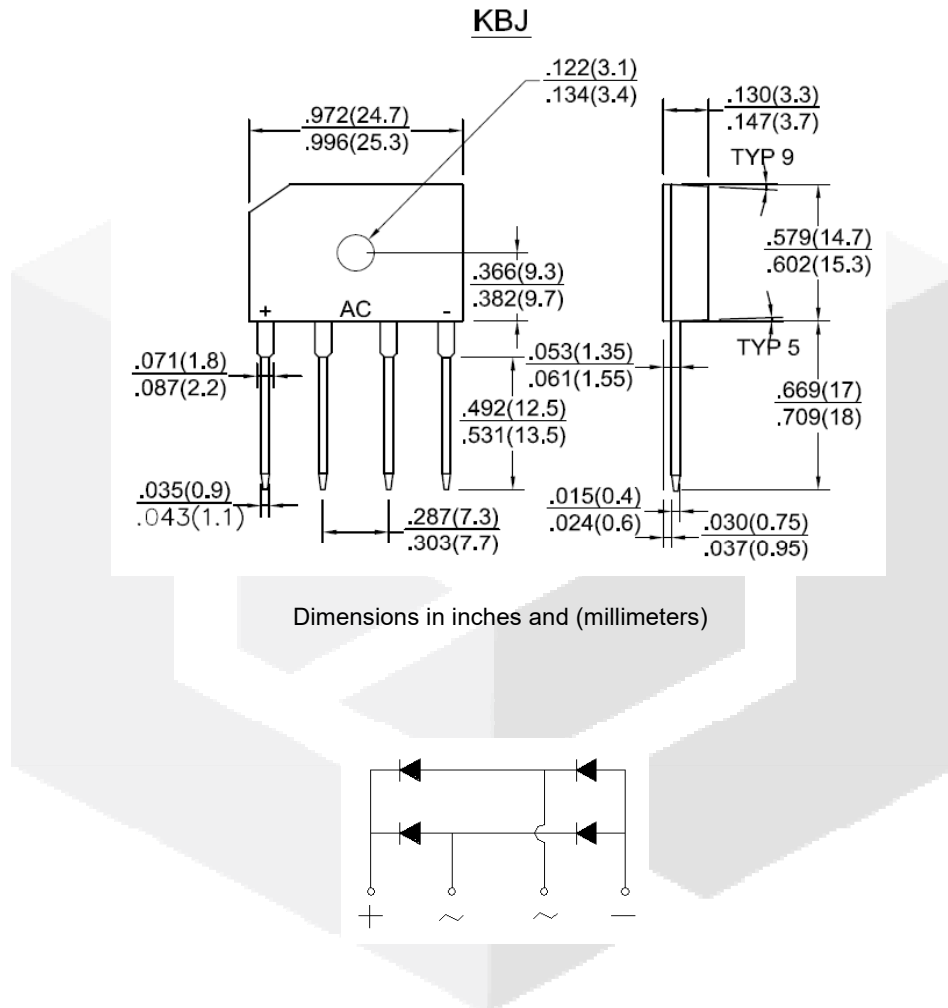

Mouser Electronics

Authorized Distributor

Click to View Pricing, Inventory, Delivery & Lifecycle Information:

[GeneSiC Semiconductor:](#)

[KBJ4005G](#) [KBJ401G](#) [KBJ402G](#) [KBJ404G](#)