

## Normally – OFF Silicon Carbide Junction Transistor

$V_{DS}$	=	1700 V
$R_{DS(ON)}$	=	230 m $\Omega$
$I_D @ T_c=125^\circ\text{C}$	=	8 A
$h_{FE} T_c=25^\circ\text{C}$	=	60

### Features

- 175 °C Maximum Operating Temperature
- Gate Oxide Free SiC Switch
- Exceptional Safe Operating Area
- Excellent Gain Linearity
- Temperature Independent Switching Performance
- Low Output Capacitance
- Positive Temperature Coefficient of  $R_{DS,ON}$
- Suitable for Connecting an Anti-parallel Diode

### Package

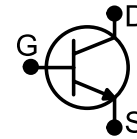
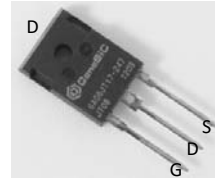
**TO-247AB**

### Advantages

- Compatible with Si MOSFET/IGBT Gate Drive ICs
- > 20  $\mu\text{s}$  Short-Circuit Withstand Capability
- Lowest-in-class Conduction Losses
- High Circuit Efficiency
- Minimal Input Signal Distortion
- High Amplifier Bandwidth

### Applications

- Down Hole Oil Drilling, Geothermal Instrumentation
- Hybrid Electric Vehicles (HEV)
- Solar Inverters
- Switched-Mode Power Supply (SMPS)
- Power Factor Correction (PFC)
- Induction Heating
- Uninterruptible Power Supply (UPS)
- Motor Drives

### Absolute Maximum Ratings

Parameter	Symbol	Conditions	Value	Unit	Notes
Drain – Source Voltage	$V_{DS}$	$V_{GS} = 0\text{ V}$	1700	V	Fig. 6
Continuous Drain Current	$I_D$	$T_C = 125^\circ\text{C}$	8	A	Fig. 19
Continuous Gate Current	$I_{GM}$		1.5	A	
Turn-Off Safe Operating Area	RBSOA	$T_{VJ} = 175^\circ\text{C}$ , $I_G = 1\text{ A}$ , Clamped Inductive Load	$I_{D,max} = 8$ @ $V_{DS} \leq V_{DSmax}$	A	Fig. 16
Short Circuit Safe Operating Area	SCSOA	$T_{VJ} = 175^\circ\text{C}$ , $I_G = 1\text{ A}$ , $V_{DS} = 1200\text{ V}$ , Non Repetitive	20	$\mu\text{s}$	
Reverse Gate – Source Voltage	$V_{SG}$		30	V	
Reverse Drain – Source Voltage	$V_{SD}$		50	V	
Power Dissipation	$P_{tot}$	$T_C = 125^\circ\text{C}$	48	W	Fig. 14
Storage Temperature	$T_{stg}$		-55 to 175	$^\circ\text{C}$	

### Electrical Characteristics

Parameter	Symbol	Conditions	Value			Unit	Notes
			Min.	Typical	Max.		
<b>On State Characteristics</b>							
Drain – Source On Resistance	$R_{DS(ON)}$	$I_D = 8\text{ A}$ , $T_J = 25^\circ\text{C}$	230			m $\Omega$	Fig. 5
		$I_D = 8\text{ A}$ , $T_J = 125^\circ\text{C}$	410				
		$I_D = 8\text{ A}$ , $T_J = 175^\circ\text{C}$	560				
Gate Forward Voltage	$V_{GS(FWD)}$	$I_G = 500\text{ mA}$ , $T_J = 25^\circ\text{C}$	3.0			V	Fig. 4
		$I_G = 500\text{ mA}$ , $T_J = 175^\circ\text{C}$	2.8				
DC Current Gain	$h_{FE}$	$V_{DS} = 5\text{ V}$ , $I_D = 8\text{ A}$ , $T_J = 25^\circ\text{C}$	60			–	Fig. 5
		$V_{DS} = 5\text{ V}$ , $I_D = 8\text{ A}$ , $T_J = 175^\circ\text{C}$	40				
<b>Off State Characteristics</b>							
Drain Leakage Current	$I_{DSS}$	$V_R = 1700\text{ V}$ , $V_{GS} = 0\text{ V}$ , $T_J = 25^\circ\text{C}$	0.2			$\mu\text{A}$	Fig. 6
		$V_R = 1700\text{ V}$ , $V_{GS} = 0\text{ V}$ , $T_J = 125^\circ\text{C}$	0.5				
		$V_R = 1700\text{ V}$ , $V_{GS} = 0\text{ V}$ , $T_J = 175^\circ\text{C}$	2.0				
Gate Leakage Current	$I_{SG}$	$V_{SG} = 20\text{ V}$ , $T_J = 25^\circ\text{C}$	20			nA	

**Electrical Characteristics**

Parameter	Symbol	Conditions	Value			Unit	Notes
			Min.	Typical	Max.		
<b>Capacitance Characteristics</b>							
Input Capacitance	$C_{iss}$	$V_{GS} = 0\text{ V}, V_D = 800\text{ V}, f = 1\text{ MHz}$		850		pF	Fig. 7
Reverse Transfer/Output Capacitance	$C_{rss}/C_{oss}$	$V_D = 800\text{ V}, f = 1\text{ MHz}$		20		pF	Fig. 7
Output Capacitance Stored Energy	$E_{OSS}$	$V_{GS} = 0\text{ V}, V_D = 1000\text{ V}, f = 1\text{ MHz}$		8.6		μJ	Fig. 8
<b>Switching Characteristics<sup>1</sup></b>							
Internal Gate Resistance, Zero Bias	$R_{G(INT-ZERO)}$	$f = 1\text{ MHz}, V_{AC} = 25\text{ mV}, T_J = 175\text{ °C}$		6.0		Ω	
Internal Gate Resistance, On	$R_{G(INT-ON)}$	$V_{GS} > 2.5\text{ V}$		0.9		Ω	
Turn On Delay Time	$t_{d(on)}$	$T_J = 25\text{ °C}, V_{DS} = 1100\text{ V}, I_D = 8\text{ A},$ $R_{G(EXT)} = 20\text{ Ω}, C_G = 9\text{ nF},$ $V_G = 20/-5\text{ V}, \text{Load} = 138\text{ Ω}$		12		ns	
Fall Time, $V_{DS}$	$t_f$	Refer to Fig. 20 for $I_G$ Waveform		23		ns	Fig. 9, 11
Turn Off Delay Time	$t_{d(off)}$			20		ns	
Rise Time, $V_{DS}$	$t_r$			14		ns	Fig. 10, 12
Turn On Delay Time	$t_{d(on)}$	$T_J = 175\text{ °C}, V_{DS} = 1100\text{ V}, I_D = 8\text{ A},$ $R_{G(EXT)} = 20\text{ Ω}, C_G = 9\text{ nF},$ $V_G = 20/-5\text{ V}, \text{Load} = 138\text{ Ω}$		12		ns	
Fall Time, $V_{DS}$	$t_f$	Refer to Fig. 20 for $I_G$ Waveform		22		ns	Fig. 9
Turn Off Delay Time	$t_{d(off)}$			31		ns	
Rise Time, $V_{DS}$	$t_r$			11		ns	Fig. 10
Turn-On Energy Per Pulse	$E_{on}$	$T_J = 25\text{ °C}, V_{DS} = 1100\text{ V}, I_D = 8\text{ A},$ $R_{G(EXT)} = 20\text{ Ω}, C_G = 9\text{ nF},$ $V_G = 20/-5\text{ V}, \text{Load} = 1.05\text{ mH}$		267		μJ	Fig. 9, 11
Turn-Off Energy Per Pulse	$E_{off}$			23		μJ	Fig. 10, 12
Total Switching Energy	$E_{tot}$			290		μJ	
Turn-On Energy Per Pulse	$E_{on}$	$T_J = 175\text{ °C}, V_{DS} = 1100\text{ V}, I_D = 8\text{ A},$ $R_{G(EXT)} = 20\text{ Ω}, C_G = 9\text{ nF},$ $V_G = 20/-5\text{ V}, \text{Load} = 1.05\text{ mH}$		253		μJ	Fig. 9
Turn-Off Energy Per Pulse	$E_{off}$			12		μJ	Fig. 10
Total Switching Energy	$E_{tot}$			265		μJ	

<sup>1</sup> – All times are relative to the Drain-Source Voltage  $V_{DS}$ 
**Thermal Characteristics**

Thermal resistance, junction - case	$R_{thJC}$		1.03		°C/W	Fig. 17
-------------------------------------	------------	--	------	--	------	---------

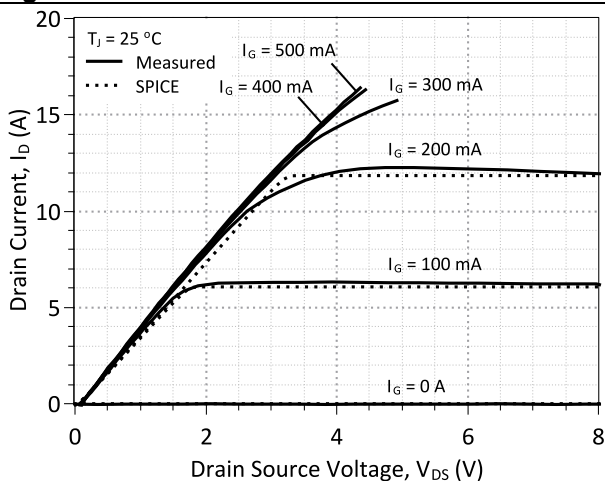
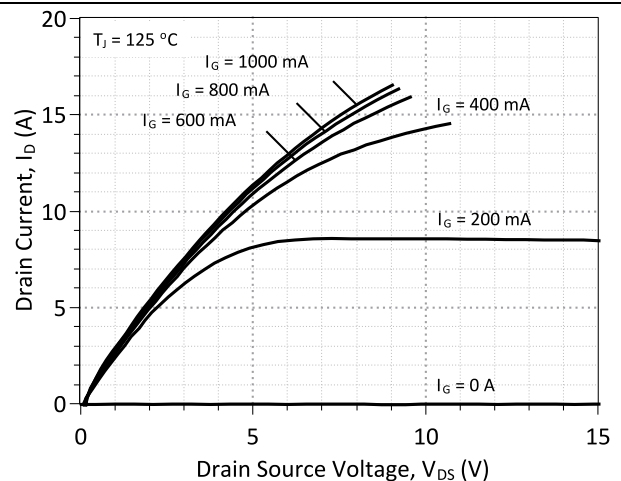
**Figures**

**Figure 1: Typical Output Characteristics at 25 °C**

**Figure 2: Typical Output Characteristics at 125 °C**

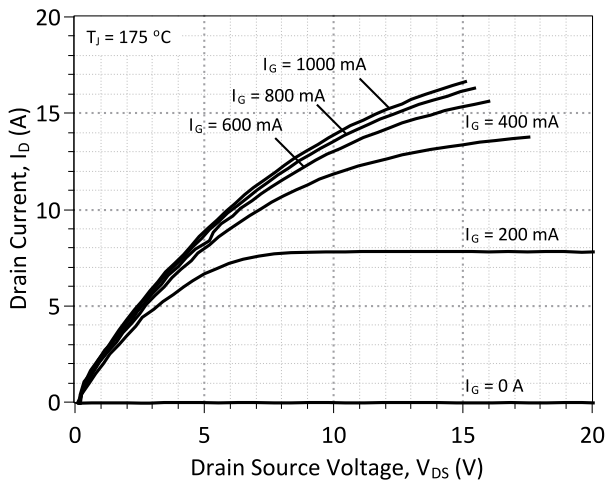

Figure 3: Typical Output Characteristics at 175 °C

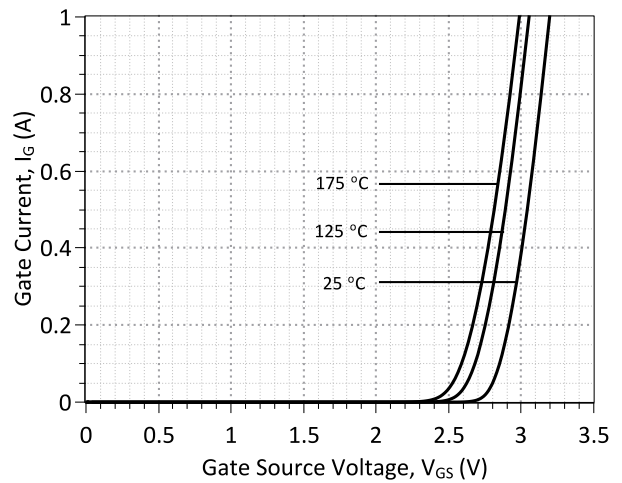

Figure 4: Typical Gate Source I-V Characteristics vs. Temperature

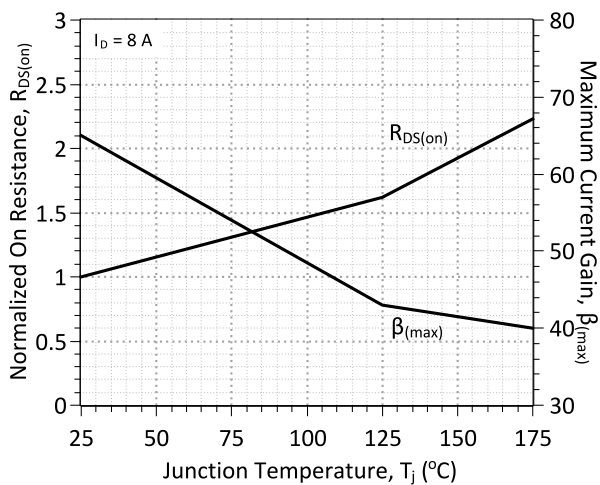

Figure 5: Normalized On-Resistance and Current Gain vs. Temperature

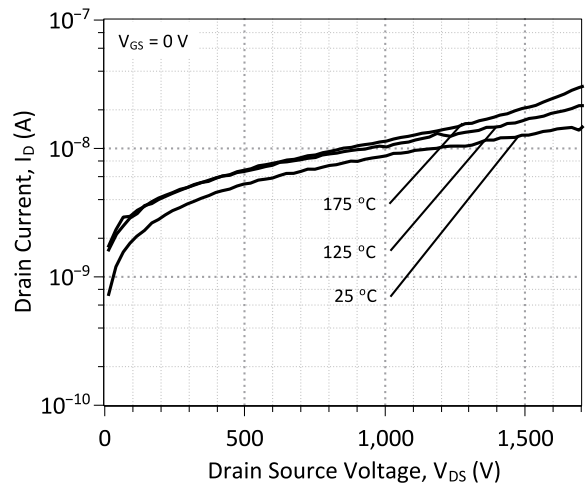

Figure 6: Typical Blocking Characteristics

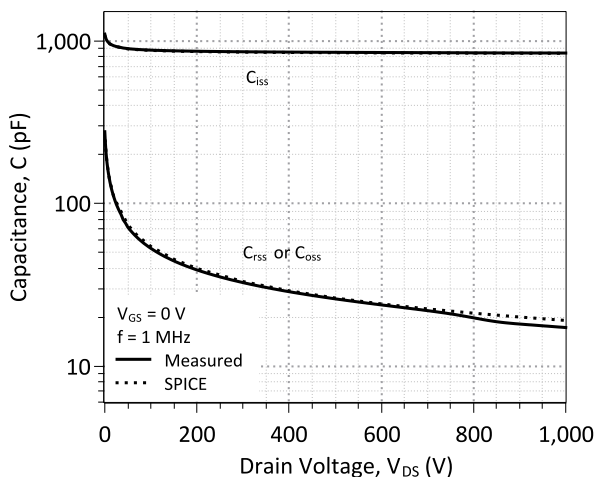

Figure 7: Input, Output, and Reverse Transfer Capacitance

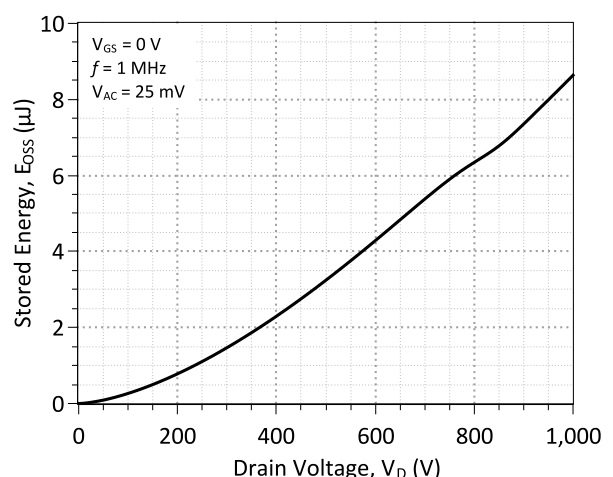
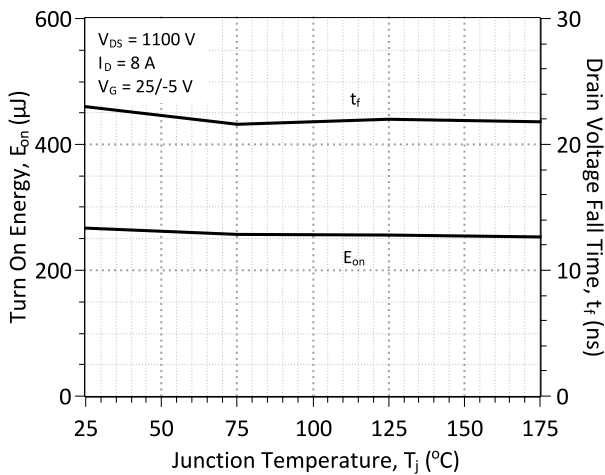
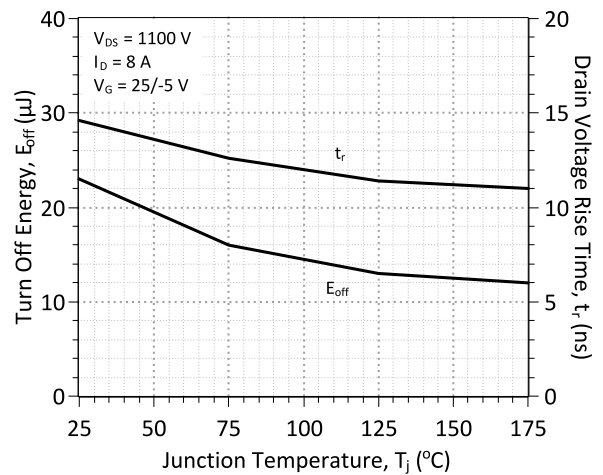

Figure 8: Output Capacitance Stored Energy



**Figure 9: Typical Turn On Energy Losses and Switching Times vs. Temperature**



**Figure 10: Typical Turn Off Energy Losses and Switching Times vs. Temperature**

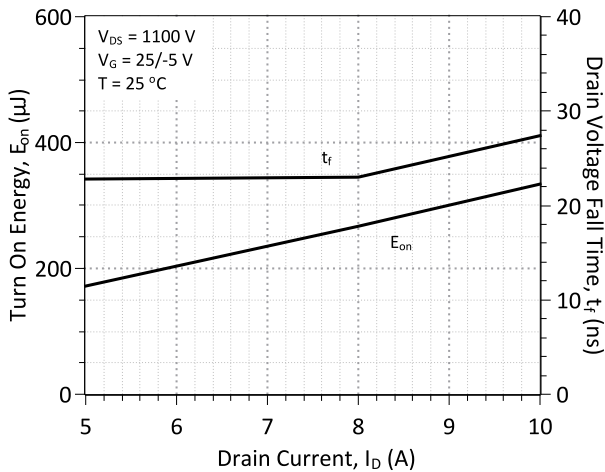

**Figure 11: Typical Turn On Energy Losses and Switching Times vs. Drain Current**

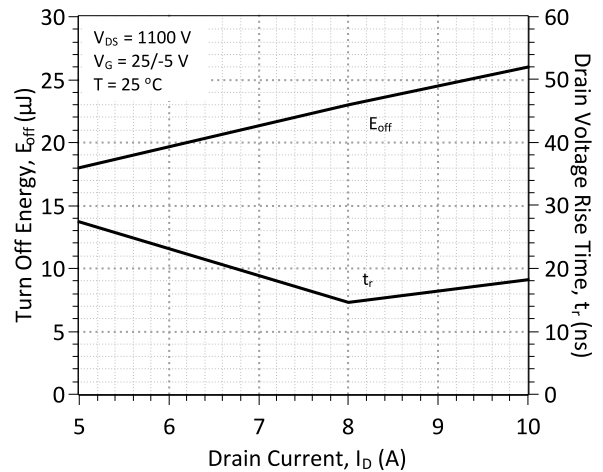

**Figure 12: Typical Turn Off Energy Losses and Switching Times vs. Drain Current**

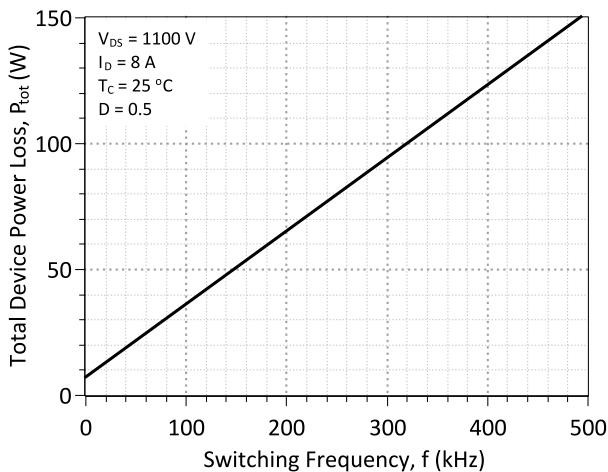

**Figure 13: Typical Hard Switched Device Power Loss vs. Switching Frequency<sup>2</sup>**

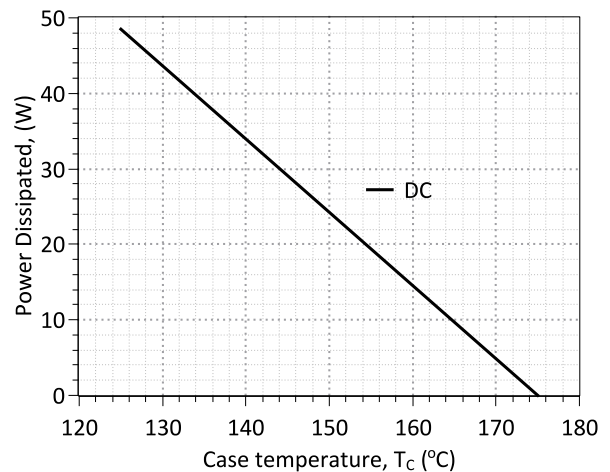

**Figure 14: Power Derating Curve**

<sup>2</sup> – Representative values based on device conduction and switching loss. Actual losses will depend on gate drive conditions, device load, and circuit topology.

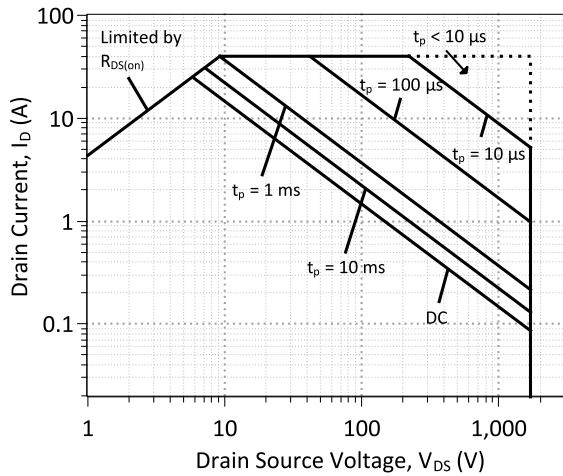

Figure 15: Forward Bias Safe Operating Area at  $T_c = 25\text{ }^\circ\text{C}$

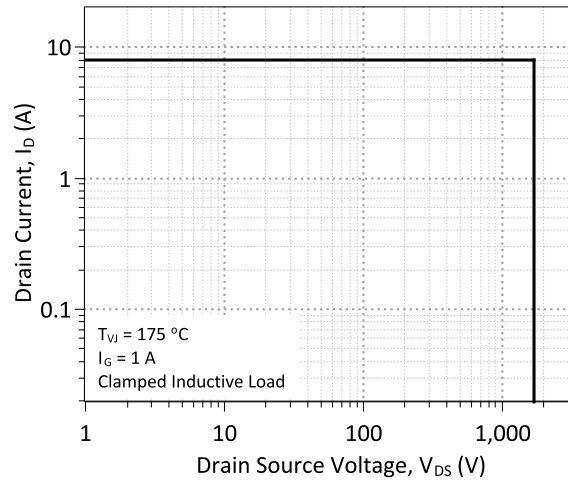

Figure 16: Turn-Off Safe Operating Area

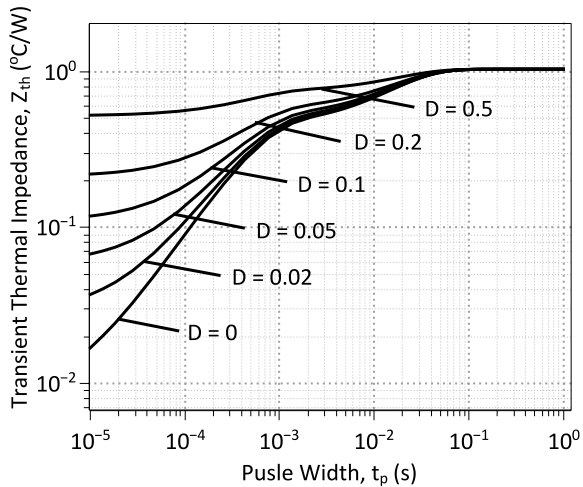

Figure 17: Transient Thermal Impedance

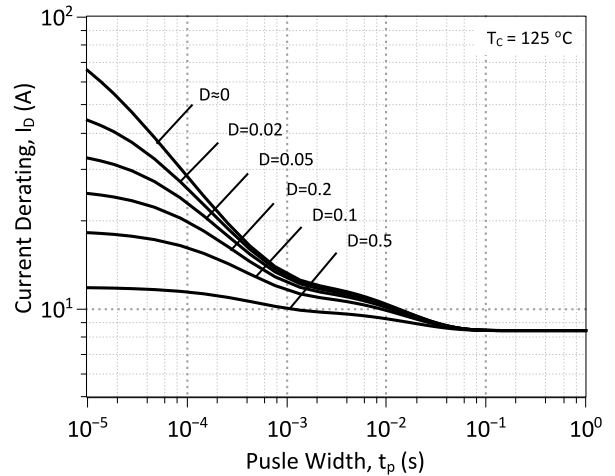

Figure 18: Drain Current Derating vs. Pulse Width

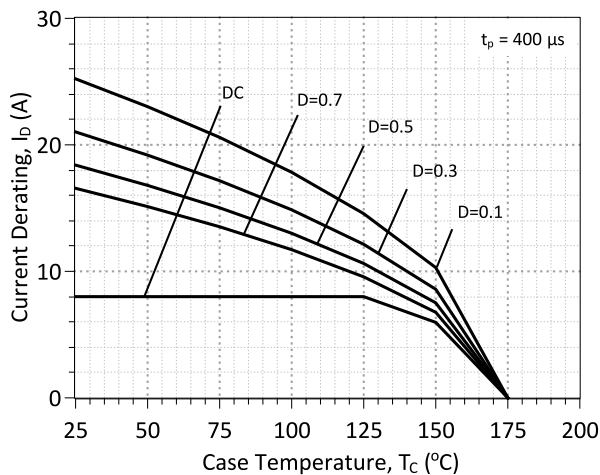

Figure 19: Drain Current Derating vs. Temperature

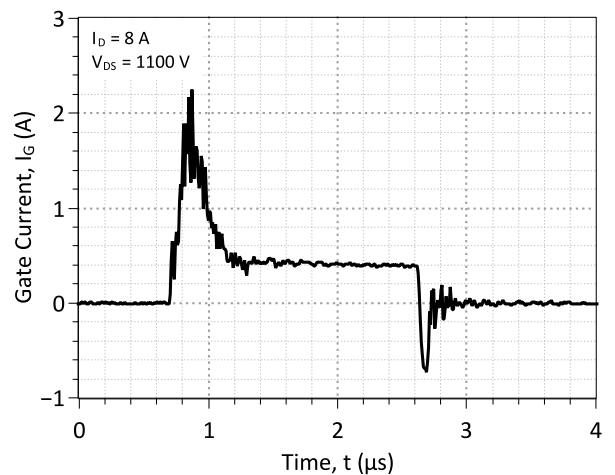
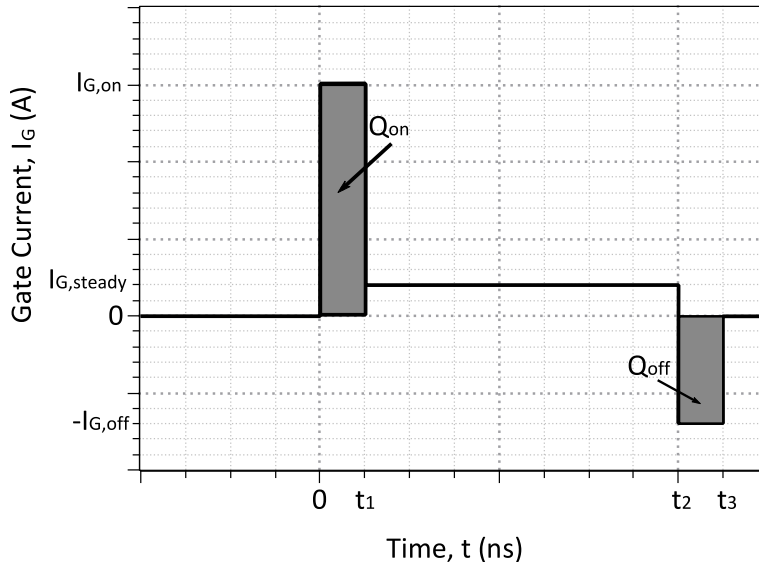

Figure 20: Typical Gate Current Waveform

## Driving the GA08JT17-247

### A. Gate Drive Theory of Operation

The SJT is a current controlled transistor which requires a positive gate current for turn-on as well as to remain in on-state. An ideal gate current waveform for ultra-fast switching of the SJT, while maintaining low gate drive losses, is shown in Figure 21.



**Figure 21: Idealized Gate Current Waveform**

#### Gate Currents, $I_{G,pk}/-I_{G,pk}$ and Voltages during Turn-On and Turn-Off

An SJT is rapidly switched from its blocking state to on-state, when the necessary gate charge,  $Q_G$ , for turn-on is supplied by a burst of high gate current,  $I_{G,on}$ , until the gate-source capacitance,  $C_{GS}$ , and gate-drain capacitance,  $C_{GD}$ , are fully charged.

$$I_{G,on} * t_1 \geq Q_{gs} + Q_{gd}$$

The  $I_{G,on}$  pulse should ideally terminate, when the drain voltage falls to its on-state value, in order to avoid unnecessary drive losses during the steady on-state. In practice, the rise time of the  $I_{G,on}$  pulse is affected by the parasitic inductances,  $L_{par}$  in the TO-247 package and drive circuit. A voltage developed across the parasitic inductance in the source path,  $L_s$ , can de-bias the gate-source junction, when high drain currents begin to flow through the device. The applied gate voltage should be maintained high enough, above the  $V_{GS,ON}$  level to counter these effects.

A high negative peak current,  $-I_{G,off}$  is recommended at the start of the turn-off transition, in order to rapidly sweep out the injected carriers from the gate, and achieve rapid turn-off. While satisfactory turn off can be achieved with  $V_{GS} = 0$  V, a negative gate voltage  $V_{GS}$  may be used in order to speed up the turn-off transition.

#### Steady On-State

After the device is turned on,  $I_G$  may be advantageously lowered to  $I_{G,steady}$  for reducing unnecessary gate drive losses. The  $I_{G,steady}$  is determined by noting the DC current gain,  $h_{FE}$ , of the device.

The desired  $I_{G,steady}$  is determined by the peak device junction temperature  $T_J$  during operation, drain current  $I_D$ , DC current gain  $h_{FE}$ , and a 50 % safety margin to ensure operating the device in the saturation region with low on-state voltage drop by the equation:

$$I_{G,steady} \approx \frac{I_D}{h_{FE}(T, I_D)} * 1.5$$

**B. Gate Drive Implementation Examples**
**Using the IXYS IX2204 Gate Driver**

The IXYS IX2204 is a dual output gate drive integrated circuit which can be used to drive an SJT by supplying the required gate drive current  $I_G$  in a low-power gate drive solution. This configuration features an external gate capacitor,  $C_G$ , which creates the brief current peak  $I_{G,on}$  during device turn-on and  $I_{G,off}$  during turn-off for fast switching and an external gate resistor  $R_{G(EXT)}$  to set the continuous gate current  $I_{G,steady}$  required for the device to remain on. This configuration is shown in Figure 22 with further details provided below.

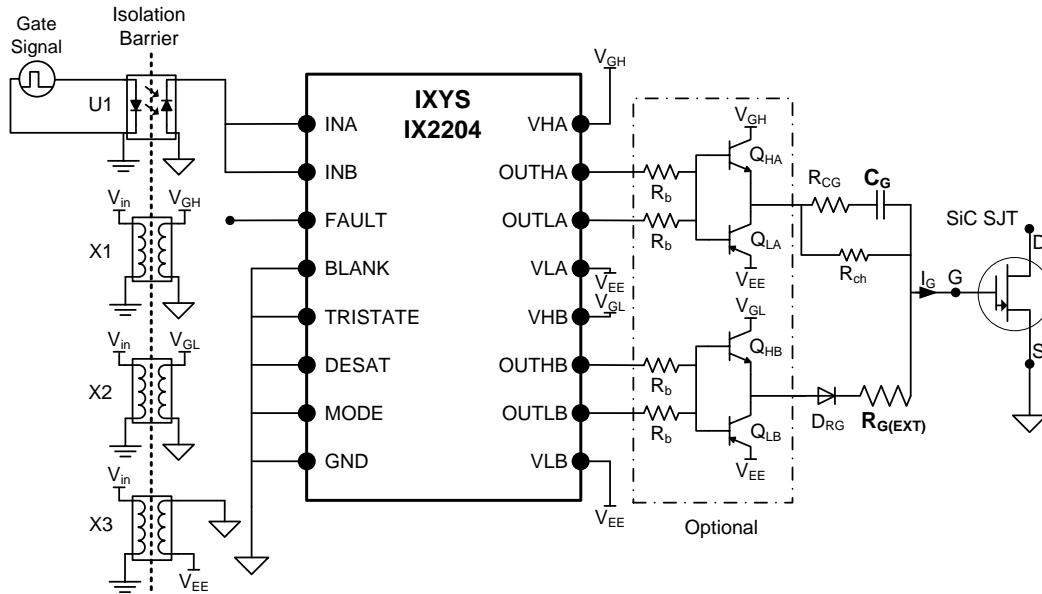

Figure 22: Gate drive configuration using an IXYS IX2204 gate drive IC.

Table 1: Recommended Component List for implementing the IX2204 based Gate Drive for the GA08JT17-247

Reference	Component	Description	Suggested Part
$R_{G(EXT)}$	Gate Resistance, External	2.0 $\Omega$ , 2 W	CRM2512-JW-2R2ELF
$C_G$	Gate Capacitance	10 nF	C1812C103J1GACTU
$R_{CG}$	Damping Resistor	1.0 $\Omega$ , 0.5 W	ERJ-1TYJ1R0U
$D_{RG}$	Silicon Schottky Diode	40 V, 2 A	SS24T3G
$R_b$	BJT Base Resistor	1.0 $\Omega$ , 0.5 W	ERJ-1TYJ1R0U
$Q_{HA}, Q_{HB}$	Current Boost NPN	40 V, 8 A, Silicon NPN BJT	MJD44H11
$Q_{LA}, Q_{LB}$	Current Boost PNP	40 V, 8 A, Silicon PNP BJT	MJD45H11
U1	Signal Isolator	Opto-Isolator –or– Transformer Isolator	ACPL-4800 / ADUM3210
X1	DC/DC Converter, $V_{GH}$ Supply	$V_{OUT} = +20$ V, $V_{IN} = +12$ V, 2 W, $V_{ISO} = 5.2$ kV	MGJ2D122005SC
X2	DC/DC Converter, $V_{GL}$ Supply	$V_{OUT} = +5$ V, $V_{IN} = +12$ V, 3 W, $V_{ISO} = 3.0$ kV	MEV3S1205SC
X3	DC/DC Converter, $V_{EE}$ Supply	$V_{OUT} = -5$ V, $V_{IN} = +12$ V, 2 W, $V_{ISO} = 5.2$ kV	MGJ2D122005SC

**Voltage Supply Selection**

The IX2204 gate drive design requires three supply voltages  $V_{GH}$ ,  $V_{GL}$ , and  $V_{EE}$  (listed in Table 2) optionally supplied through DC/DC converters. During device turn-on,  $V_{GH}$  charges the external capacitor  $C_G$  thereby delivering the narrow width, high current pulse  $I_{G,on}$  to the SGT gate and charges the SGT's internal terminal capacitances  $C_{GD}$  and  $C_{GS}$ . For a given level of parasitic inductance in the gate circuit and SGT package, the rise time of  $I_{G,on}$  is controlled by the choice of  $V_{GH}$  and  $C_G$ . During the steady on-state,  $V_{GL}$  in combination with the internal and external gate resistances provides a continuous gate current for the GA08JT17-247 to remain on. The  $V_{EE}$  supply sets the gate negative during turn-off and steady off-state for faster switching and to avoid spurious turn-on which may be caused by external circuit noise. The power rating of the voltage supplies should be adequate to meet the gate drive power requirements as determined by

$$P_{min,VGH} = \frac{1}{2} C_G V_{GH}^2 f_{sw}$$

$$P_{min,VEE} = \frac{1}{2} C_G V_{EE}^2 f_{sw}$$

$$P_{min,VGL} = V_{GL} I_{G,steady} D$$

**Table 2: IX2204 Gate Drive Example Component List**

Symbol	Parameter	Values	
		Range	Typical
V <sub>GH</sub>	Supply Voltage, Driver Output A	15 – 20	+ 20.0
V <sub>GL</sub>	Supply Voltage, Driver Output B	5.0 – 7.0	+ 5.0
V <sub>EE</sub>	Negative Supply Voltage	-10 – GND	- 5.0

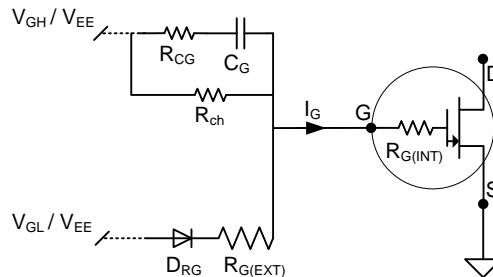
**Gate Capacitor C<sub>G</sub> Selection**

**Figure 23: Primary gate drive circuit passive components with series gate resistance Schottky rectifier.**

An external gate capacitor C<sub>G</sub> connected directly to the device gate pin delivers the positive current peak I<sub>G,on</sub> during device turn-on and the negative current peak I<sub>G,off</sub> during turn-off. A low value resistor R<sub>CG</sub> is connected in series with C<sub>G</sub> to damp potential high-frequency oscillation. A high value resistor R<sub>ch</sub> in parallel with C<sub>G</sub> sets the SJT gate to a defined potential (-V<sub>EE</sub>) during steady off-state.

At device turn-on, C<sub>G</sub> is pulled to V<sub>GH</sub> which produces a transient peak of gate voltage and current. This current peak rapidly charges the internal SJT C<sub>GS</sub> and C<sub>GD</sub> capacitances. A Schottky diode, D<sub>RG</sub>, in series with R<sub>G(EXT)</sub> blocks any C<sub>G</sub> induced current from draining out through R<sub>G(EXT)</sub> and ensures that all of the charge within C<sub>G</sub> flows only into the device gate, allowing for an ultra-fast device turn-on. During steady on-state, a potential of V<sub>GH</sub> - V<sub>GS</sub> = V<sub>GH</sub> - 3 V is across C<sub>G</sub>. When the device is turned off, C<sub>G</sub> is pulled to negative V<sub>EE</sub> and V<sub>GS</sub> is pulled to a transient peak of V<sub>GS,turn-off</sub> = V<sub>EE</sub> - (V<sub>GH</sub> - 3 V), this induces the negative current peak I<sub>G,off</sub> out of the gate which discharges the SJT internal capacitances.

**External Gate Resistor R<sub>G(EXT)</sub> Selection**

An external gate resistor R<sub>G(EXT)</sub> connected directly to the SJT gate pin acts to deliver a continuous current I<sub>G,steady</sub> during steady on-state. The gate current is determined by:

$$I_{G,steady} = \frac{V_{GL} - V_{GS(FWD)} - V_{Sch}}{R_{G(EXT)} + R_{G(INT-ON)}}$$

The on-state gate-source voltage V<sub>GS(FWD)</sub> can be approximated to 3 V and the Schottky on-state voltage V<sub>Sch</sub> can be approximated to 0.3 V which simplifies the equation to:

$$I_{G,steady} = \frac{V_{GL} - 3.3V}{R_{G(EXT)} + R_{G(INT-ON)}}$$

The desired I<sub>G,steady</sub> is determined by the peak device junction temperature T<sub>J</sub> during operation, drain current I<sub>D</sub>, DC current gain β, and a 50 % safety margin to avoid operating the device in saturation. I<sub>G,steady</sub> may also be approximated from the temperature dependent on-state curves of the device in Figures **Error! Reference source not found.** – **Error! Reference source not found.**, provided that a 50 % increase is given.

**Table 3: Passive Output Component List**

Symbol	Parameter	Values		Units
		Range	Typical	
C <sub>G</sub>	Gate Capacitor, External	5 – 20	10	nF
R <sub>CG</sub>	Damping Resistor of Gate Capacitor	0.5 – 2.0	1.0	Ω
R <sub>ch</sub>	Charging Resistor	500 – 10k	1k	Ω
R <sub>G(EXT)</sub>	Gate Resistor, External	0.4 – 5	2	Ω
R <sub>G(INT-ON)</sub>	Gate Resistance, Internal, On-State	0.5 – 1.5	0.9	Ω
D <sub>RG</sub>	Schottky Diode of Gate Resistor	--	--	



### Optional Gate Current Boost Network

An optional output totem-pole network may be attached to the IX2204 output pins as shown in Figure 22 using either silicon BJTs (shown) or MOSFETs. This configuration allows the IX2204 to directly drive the BJT bases or MOSFET gates and not supply the full peak and steady state gate current entering the SJT gate. The primary gate current delivery device is transferred to the discrete components which have higher power dissipation ratings than the IX2204.

### Voltage Supply Isolation

The DC/DC supply voltage converters are suggested to provide isolation at a minimum of twice the working  $V_{DS}$  on the SJT transistor during off-state to provide adequate protection to circuitry external to the gate drive circuit. Suggested DC/DC converters have an isolation of 3.0 kV or greater. Alternatively, DC/DC converter galvanic isolation may be bypassed and direct connection of variable voltage supplies may be done, this may be convenient during testing and prototyping but carries risk and is not suggested for extended usage.

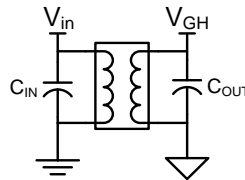

**Figure 24: Typical DC/DC converter configuration**

### Signal Isolation

The gate supply signal is suggested to be isolated to twice the working  $V_{DS}$  on the SJT during off-state to provide adequate protection to circuitry external to the gate drive circuit. This may be done using opto or galvanic isolation techniques.

### Additional Features

The IX2204 has additional functionality available which is unused in the given configuration. Desaturation detection and fault status monitoring may be implemented by un-grounding the DESAT, BLANK, and TRISTATE pins and configuring them as recommended in the IX2204 datasheet, available from IXYS. Active miller clamping is also available on other gate drive ICs which may also be desired in some SJT switching applications but is not required, refer to specific gate drive IC datasheets for more information.

## C. Alternative Gate Drive ICs

dividual product manufacturers.

Table 4 features a partial list of alternative gate drive ICs which may be used for driving the GA08JT17-247; specific product information should be obtained from the individual product manufacturers.

**Table 4: Additional Commercial Gate Drivers Compatible with GA08JT17-247**

Manufacturer	Part Number	Features				
		Optical Signal Isolation	Desaturation Detection	Active Miller Gate Clamping <sup>3</sup>	High Side Capability	Number of Outputs
Avago Tech.	HCPL-316J	✓	✓	–	✓	1
Avago Tech.	HCPL-322J	✓	✓	✓	✓	1
IXYS	IXD_604	–	–	–	✓	2
IXYS	IXD_614	–	–	–	✓	1
Micrel	MIC4452YN	–	–	–	✓	1
Microsemi	LX4510	–	–	–	✓	1
Texas Instruments	UCC27322	–	–	–	✓	1

<sup>3</sup> – Active Miller Gate Clamping recommended for  $V_{EE} = GND$  switching applications as SJT and/or output BJT secondary gate discharge path.

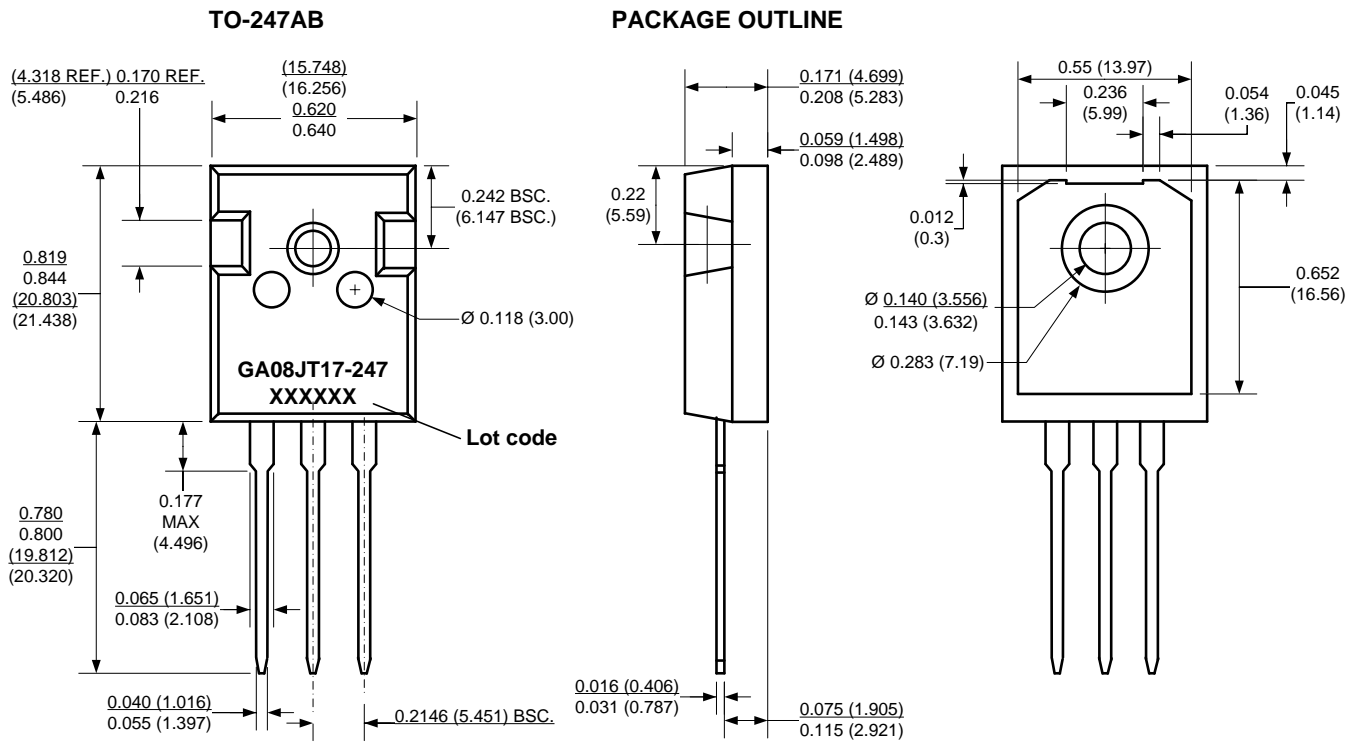
**Package Dimensions:**

**NOTE**

1. CONTROLLED DIMENSION IS INCH. DIMENSION IN BRACKET IS MILLIMETER.
2. DIMENSIONS DO NOT INCLUDE END FLASH, MOLD FLASH, MATERIAL PROTRUSIONS

Revision History			
Date	Revision	Comments	Supersedes
2014/08/26	8	Updated Electrical Characteristics	
2014/06/23	7	Updated Electrical Characteristics	
2014/02/06	6	Updated Electrical Characteristics	
2013/12/18	5	Updated Gate Drive Section	

Published by  
 GeneSiC Semiconductor, Inc.  
 43670 Trade Center Place Suite 155  
 Dulles, VA 20166

GeneSiC Semiconductor, Inc. reserves right to make changes to the product specifications and data in this document without notice.

GeneSiC disclaims all and any warranty and liability arising out of use or application of any product. No license, express or implied to any intellectual property rights is granted by this document.

Unless otherwise expressly indicated, GeneSiC products are not designed, tested or authorized for use in life-saving, medical, aircraft navigation, communication, air traffic control and weapons systems, nor in applications where their failure may result in death, personal injury and/or property damage.

## SPICE Model Parameters

This is a secure document. Please copy this code from the SPICE model PDF file on our website ([http://www.genesicsemi.com/images/products\\_sic/sjt/GA08JT17-247\\_SPICE.pdf](http://www.genesicsemi.com/images/products_sic/sjt/GA08JT17-247_SPICE.pdf)) into LTSPICE (version 4) software for simulation of the GA08JT17-247.

```
*      MODEL OF GeneSiC Semiconductor Inc.
*
*      $Revision:   1.3                $
*      $Date:      26-AUG-2014        $
*
*      GeneSiC Semiconductor Inc.
*      43670 Trade Center Place Ste. 155
*      Dulles, VA 20166
*
*      COPYRIGHT (C) 2014 GeneSiC Semiconductor Inc.
*      ALL RIGHTS RESERVED
*
* These models are provided "AS IS, WHERE IS, AND WITH NO WARRANTY
* OF ANY KIND EITHER EXPRESSED OR IMPLIED, INCLUDING BUT NOT LIMITED
* TO ANY IMPLIED WARRANTIES OF MERCHANTABILITY AND FITNESS FOR A
* PARTICULAR PURPOSE."
* Models accurate up to 2 times rated drain current.
*
.model GA08JT17 NPN
+ IS      3.73E-47
+ ISE     5.50E-27
+ EG      3.2
+ BF      63
+ BR      0.55
+ IKF     200
+ NF      1
+ NE      2.021
+ RB      6.0
+ RBM     0.9
+ IRB     1e-4
+ RE      0.103394007
+ RC      0.151605993
+ CJC     2.77E-10
+ VJC     3.023103628
+ MJC     0.460762158
+ CJE     8.23E-10
+ VJE     2.945448229
+ MJE     0.498044294
+ XTI     3
+ XTB     -0.7
+ TRC1    7.50E-3
+ VCEO    1700
+ ICRATING 8
+ MFG     GeneSiC_Semiconductor
*End of GA08JT17 SPICE Model
```

# Mouser Electronics

Authorized Distributor

Click to View Pricing, Inventory, Delivery & Lifecycle Information:

[GeneSiC Semiconductor:](#)

[GA08JT17-247](#)