



## High Speed Infrared Emitting Diodes, 850 nm, Surface Emitter Technology

VSMY2850RG



VSMY2850G



### DESCRIPTION

As part of the [SurfLight™](#) portfolio, the VSMY2850 series are infrared, 850 nm emitting diodes based on GaAlAs surface emitter chip technology with extreme high radiant intensities, high optical power and high speed, molded in clear, untinted plastic packages (with lens) for surface mounting (SMD).

### APPLICATIONS

- IrDA compatible data transmission
- Miniature light barrier
- Photointerrupters
- Optical switch
- Emitter source for proximity sensors
- IR touch panels
- IR illumination

### FEATURES

- Package type: surface mount
- Package form: GW, RGW
- Dimensions (L x W x H in mm): 2.3 x 2.3 x 2.8
- Peak wavelength:  $\lambda_p = 850$  nm
- High reliability
- High radiant power
- Very high radiant intensity
- Angle of half intensity:  $\phi = \pm 10^\circ$
- Suitable for high pulse current operation
- Terminal configurations: gullwing or reverse gullwing
- Package matches with detector VEMD2500X01 series
- Floor life: 4 weeks, MSL 2a, acc. J-STD-020
- Material categorization: For definitions of compliance please see [www.vishay.com/doc?99912](http://www.vishay.com/doc?99912)



PRODUCT SUMMARY				
COMPONENT	$I_e$ (mW/sr)	$\phi$ (deg)	$\lambda_p$ (nm)	$t_r$ (ns)
VSMY2850RG	100	$\pm 10$	850	10
VSMY2850G	100	$\pm 10$	850	10

#### Note

- Test conditions see table "Basic Characteristics"

ORDERING INFORMATION			
ORDERING CODE	PACKAGING	REMARKS	PACKAGE FORM
VSMY2850RG	Tape and reel	MOQ: 6000 pcs, 6000 pcs/reel	Reverse gullwing
VSMY2850G	Tape and reel	MOQ: 6000 pcs, 6000 pcs/reel	Gullwing

#### Note

- MOQ: minimum order quantity



<b>ABSOLUTE MAXIMUM RATINGS</b> ( $T_{amb} = 25\text{ }^{\circ}\text{C}$ , unless otherwise specified)				
PARAMETER	TEST CONDITION	SYMBOL	VALUE	UNIT
Reverse voltage		$V_R$	5	V
Forward current		$I_F$	100	mA
Peak forward current	$t_p/T = 0.5, t_p = 100\text{ }\mu\text{s}$	$I_{FM}$	200	mA
Surge forward current	$t_p = 100\text{ }\mu\text{s}$	$I_{FSM}$	1	A
Power dissipation		$P_V$	190	mW
Junction temperature		$T_j$	100	$^{\circ}\text{C}$
Operating temperature range		$T_{amb}$	- 40 to + 85	$^{\circ}\text{C}$
Storage temperature range		$T_{stg}$	- 40 to + 100	$^{\circ}\text{C}$
Soldering temperature	acc. figure 10, J-STD-020	$T_{sd}$	260	$^{\circ}\text{C}$
Thermal resistance junction/ambient	J-STD-051, soldered on PCB	$R_{thJA}$	250	K/W

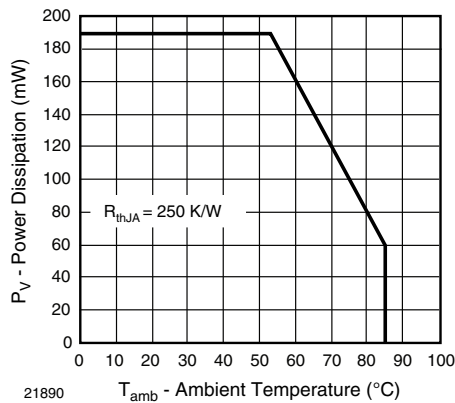

Fig. 1 - Power Dissipation Limit vs. Ambient Temperature

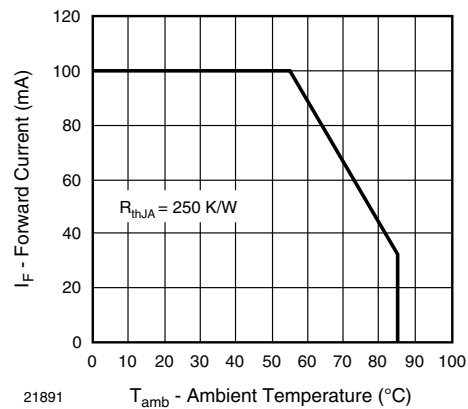

Fig. 2 - Forward Current Limit vs. Ambient Temperature

<b>BASIC CHARACTERISTICS</b> ( $T_{amb} = 25\text{ }^{\circ}\text{C}$ , unless otherwise specified)						
PARAMETER	TEST CONDITION	SYMBOL	MIN.	TYP.	MAX.	UNIT
Forward voltage	$I_F = 100\text{ mA}, t_p = 20\text{ ms}$	$V_F$		1.65	1.9	V
	$I_F = 1\text{ A}, t_p = 100\text{ }\mu\text{s}$	$V_F$		2.9		V
Temperature coefficient of $V_F$	$I_F = 100\text{ mA}$	$TK_{V_F}$		- 1.6		mV/K
Reverse current		$I_R$	not designed for reverse operation			$\mu\text{A}$
Junction capacitance	$V_R = 0\text{ V}, f = 1\text{ MHz}, E = 0\text{ mW/cm}^2$	$C_J$		125		pF
Radiant intensity	$I_F = 100\text{ mA}, t_p = 20\text{ ms}$	$I_e$	50	100	150	mW/sr
	$I_F = 1\text{ A}, t_p = 100\text{ }\mu\text{s}$	$I_e$		850		mW/sr
Radiant power	$I_F = 100\text{ mA}, t_p = 20\text{ ms}$	$\phi_e$		55		mW
Temperature coefficient of radiant power	$I_F = 100\text{ mA}$	$TK_{\phi_e}$		- 0.2		%/K
Angle of half intensity		$\varphi$		$\pm 10$		deg
Peak wavelength	$I_F = 100\text{ mA}$	$\lambda_p$	840	850	870	nm
Spectral bandwidth	$I_F = 30\text{ mA}$	$\Delta\lambda$		30		nm
Temperature coefficient of $\lambda_p$	$I_F = 30\text{ mA}$	$TK_{\lambda_p}$		0.25		nm/K
Rise time	$I_F = 100\text{ mA}, 20\% \text{ to } 80\%$	$t_r$		10		ns
Fall time	$I_F = 100\text{ mA}, 20\% \text{ to } 80\%$	$t_f$		10		ns



## BASIC CHARACTERISTICS ( $T_{amb} = 25\text{ }^{\circ}\text{C}$ , unless otherwise specified)

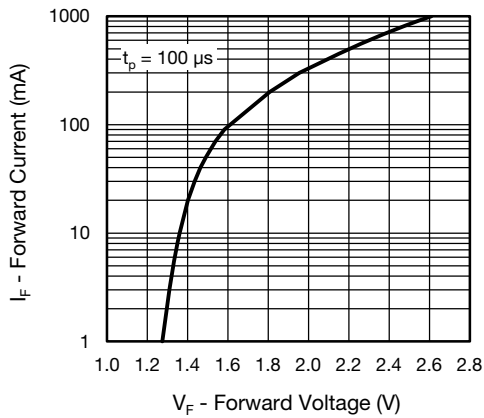

Fig. 3 - Forward Current vs. Forward Voltage

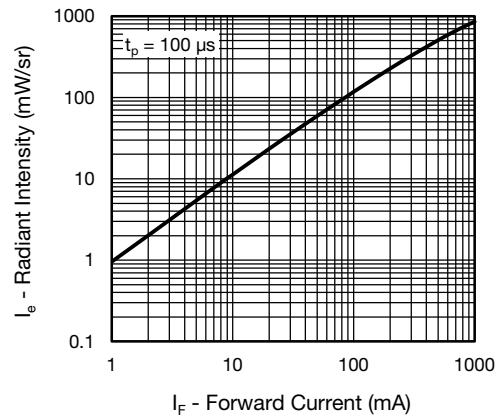

Fig. 6 - Radiant Intensity vs. Forward Current

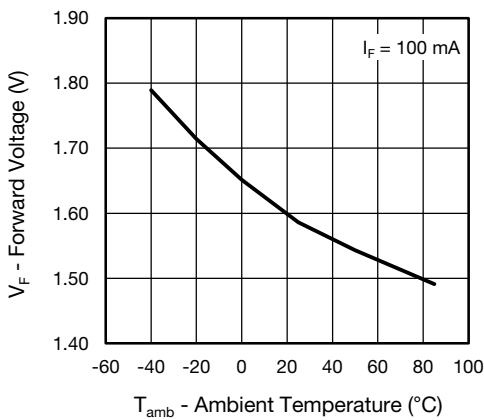

Fig. 4 - Forward Voltage vs. Ambient Temperature

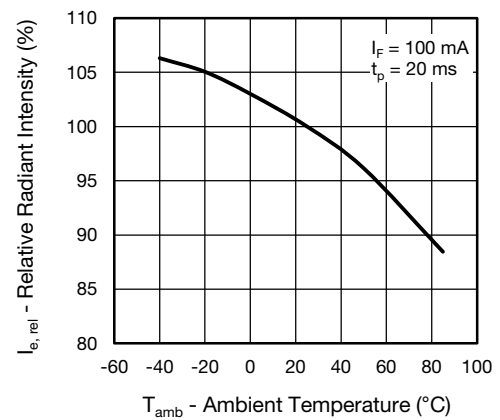

Fig. 7 - Relative Radiant Intensity vs. Ambient Temperature

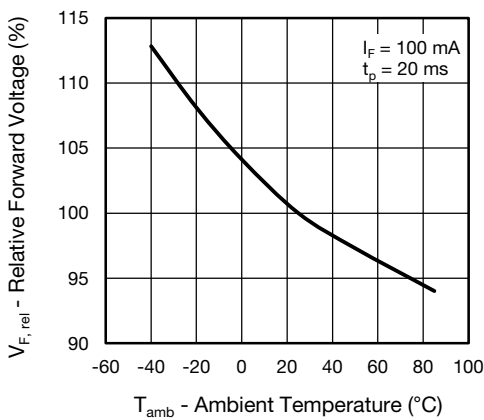

Fig. 5 - Relative Forward Voltage vs. Ambient Temperature

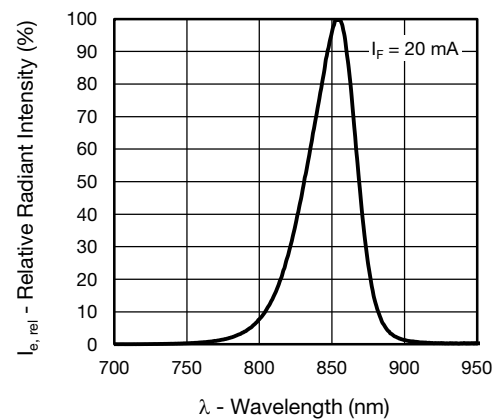

Fig. 8 - Relative Radiant Intensity vs. Wavelength

Fig. 10 - Lead (Pb)-free Reflow Solder Profile acc. J-STD-020

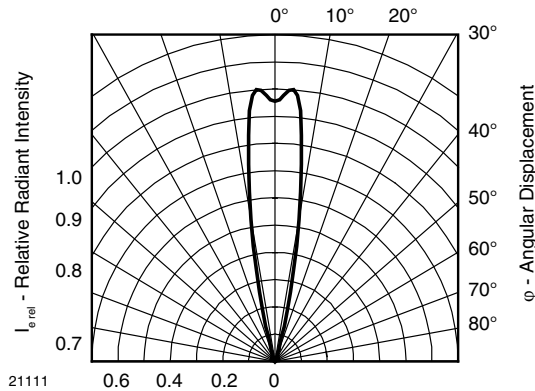
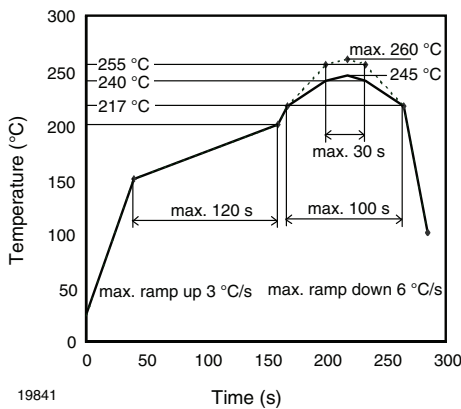

Fig. 9 - Relative Radiant Intensity vs. Angular Displacement

## SOLDER PROFILE



## DRYPACK

Devices are packed in moisture barrier bags (MBB) to prevent the products from moisture absorption during transportation and storage. Each bag contains a desiccant.

## FLOOR LIFE

Floor life (time between soldering and removing from MBB) must not exceed the time indicated on MBB label:

Floor life: 4 weeks

Conditions:  $T_{amb} < 30\text{ }^{\circ}\text{C}$ ,  $RH < 60\%$

Moisture sensitivity level 2a, acc. to J-STD-020.

## DRYING

In case of moisture absorption devices should be baked before soldering. Conditions see J-STD-020 or label. Devices taped on reel dry using recommended conditions 192 h at  $40\text{ }^{\circ}\text{C}$  (+ 5 °C),  $RH < 5\%$ .



## PACKAGE DIMENSIONS in millimeters: VSMY2850RG

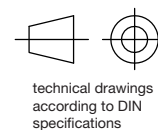
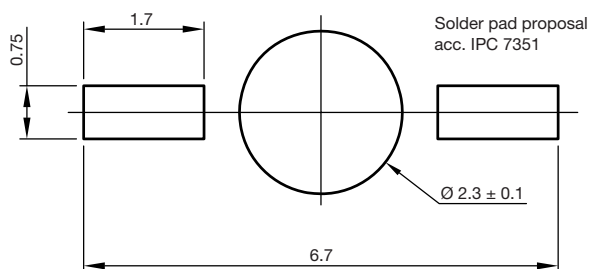
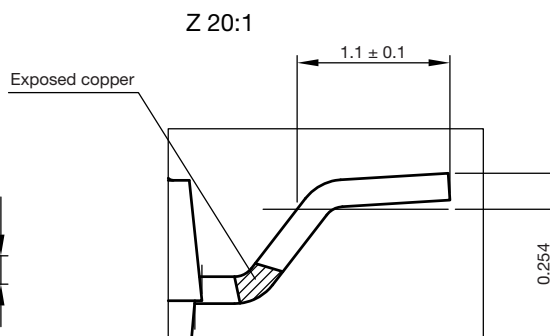
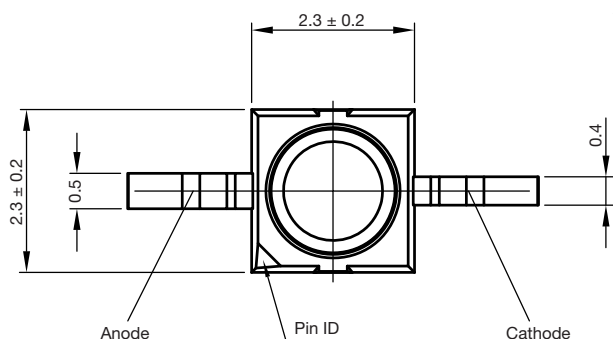
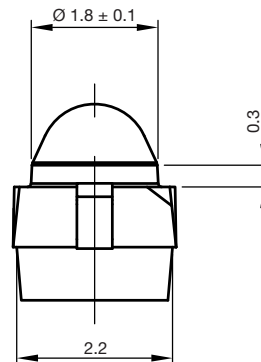
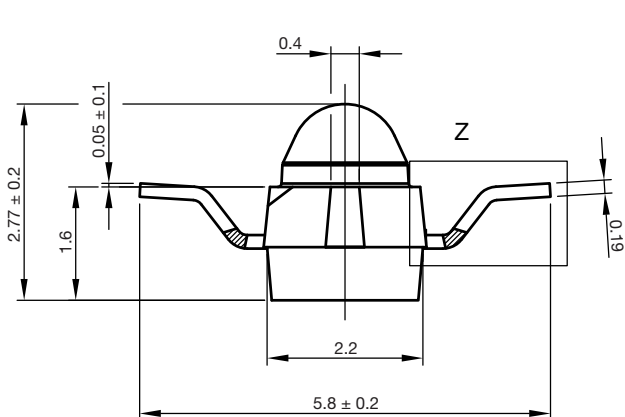

Not indicated tolerances ± 0.1

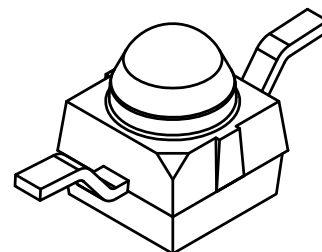

Drawing-No.: 6.544-5391.03-4  
 Issue: 1; 18.03.10  
 22100



## PACKAGE DIMENSIONS in millimeters: VSMY2850G

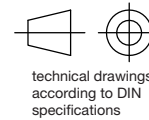
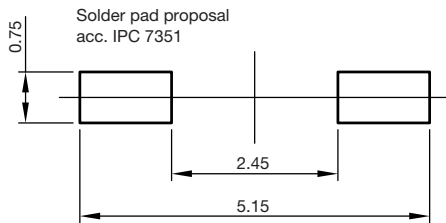
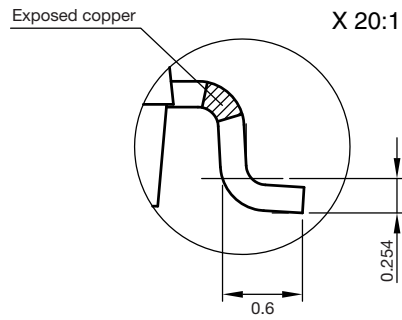
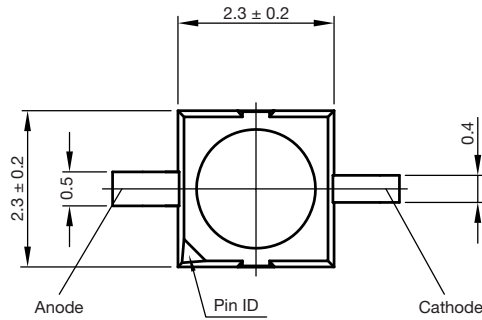
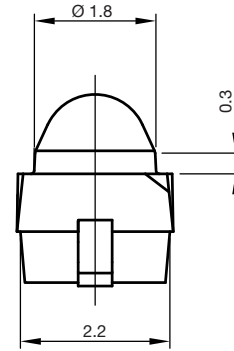
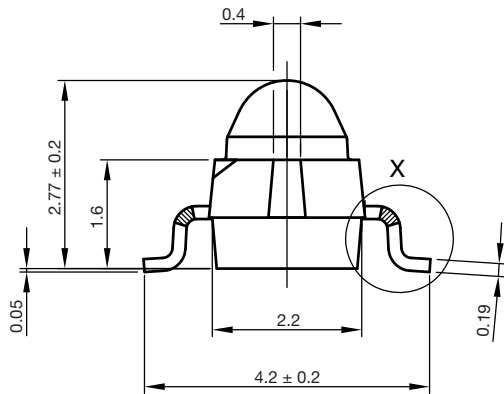

Not indicated tolerances ± 0.1

Drawing-No.: 6.544-5383.03-4  
 Issue: 1; 18.03.10  
 22099

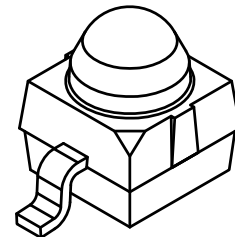



**TAPING AND REEL DIMENSIONS** in millimeters: **VSMY2850RG**

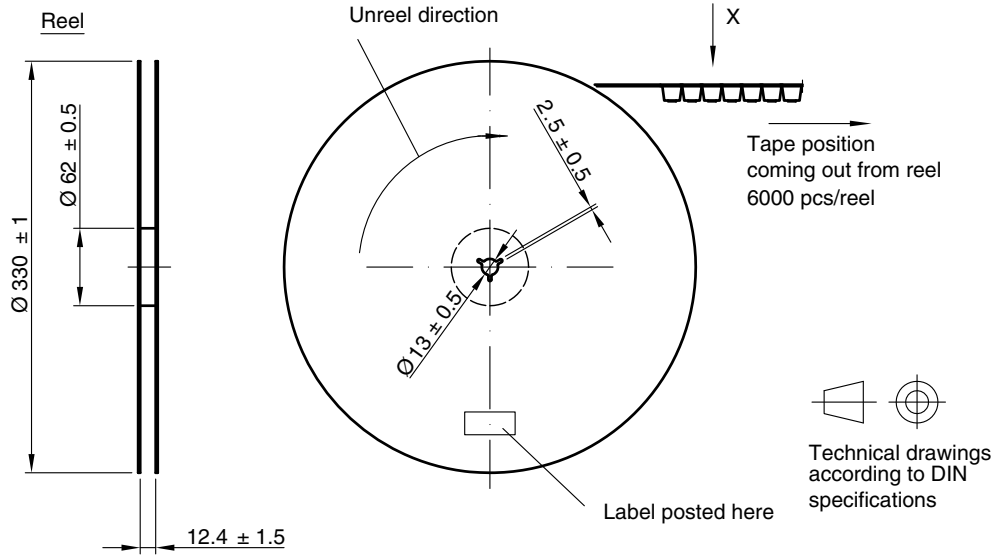

Leader and trailer tape:

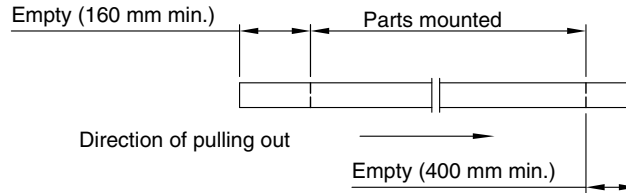

Terminal position in tape

Device	Lead I	Lead II
VEMT2000	Collector	Emitter
VEMT2500		
VEMD2000	Cathode	Anode
VEMD2500		
VSMB2000		
VSMG2000		
VSMY2850RG	Anode	Cathode

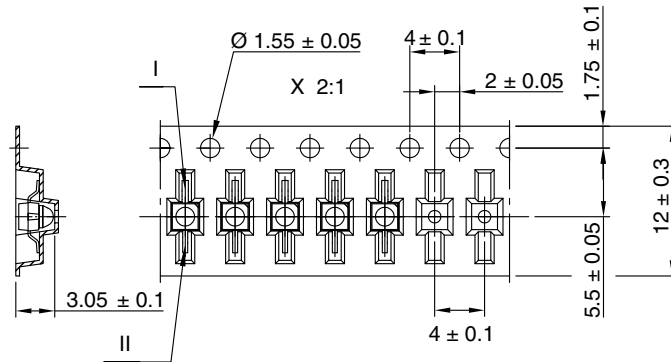

Drawing-No.: 9.800-5100.01-4  
 Issue: 2; 18.03.10  
 21572

## TAPING AND REEL DIMENSIONS in millimeters: VSMY2850G

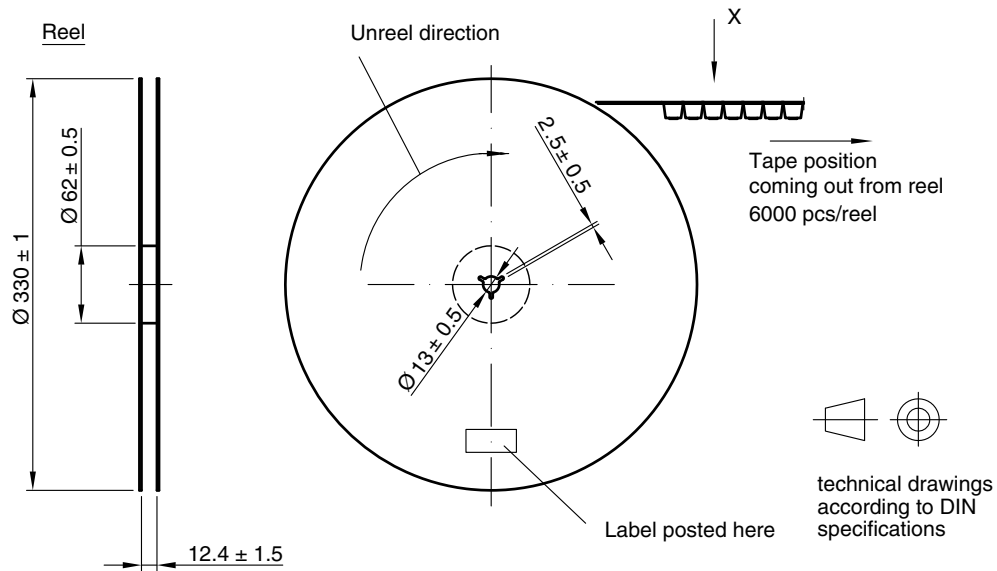

### Leader and trailer tape:

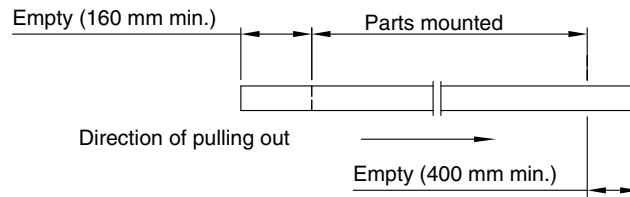

### Terminal position in tape

Device	Lead I	Lead II
VEMT2020	Collector	Emitter
VEMT2520		
VSMB2020	Cathode	Anode
VSMG2020		
VEMD2020		
VEMD2520		
VSMY2850G	Anode	Cathode

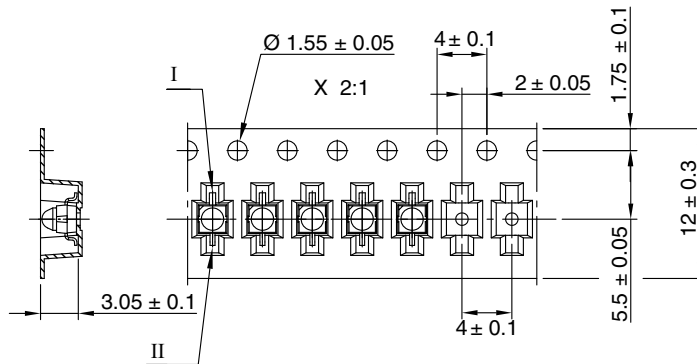

Drawing-No.: 9.800-5091.01-4

Issue: 3; 18.03.10

21571





## **Disclaimer**

ALL PRODUCT, PRODUCT SPECIFICATIONS AND DATA ARE SUBJECT TO CHANGE WITHOUT NOTICE TO IMPROVE RELIABILITY, FUNCTION OR DESIGN OR OTHERWISE.

Vishay Intertechnology, Inc., its affiliates, agents, and employees, and all persons acting on its or their behalf (collectively, "Vishay"), disclaim any and all liability for any errors, inaccuracies or incompleteness contained in any datasheet or in any other disclosure relating to any product.

Vishay makes no warranty, representation or guarantee regarding the suitability of the products for any particular purpose or the continuing production of any product. To the maximum extent permitted by applicable law, Vishay disclaims (i) any and all liability arising out of the application or use of any product, (ii) any and all liability, including without limitation special, consequential or incidental damages, and (iii) any and all implied warranties, including warranties of fitness for particular purpose, non-infringement and merchantability.

Statements regarding the suitability of products for certain types of applications are based on Vishay's knowledge of typical requirements that are often placed on Vishay products in generic applications. Such statements are not binding statements about the suitability of products for a particular application. It is the customer's responsibility to validate that a particular product with the properties described in the product specification is suitable for use in a particular application. Parameters provided in datasheets and / or specifications may vary in different applications and performance may vary over time. All operating parameters, including typical parameters, must be validated for each customer application by the customer's technical experts. Product specifications do not expand or otherwise modify Vishay's terms and conditions of purchase, including but not limited to the warranty expressed therein.

Except as expressly indicated in writing, Vishay products are not designed for use in medical, life-saving, or life-sustaining applications or for any other application in which the failure of the Vishay product could result in personal injury or death. Customers using or selling Vishay products not expressly indicated for use in such applications do so at their own risk. Please contact authorized Vishay personnel to obtain written terms and conditions regarding products designed for such applications.

No license, express or implied, by estoppel or otherwise, to any intellectual property rights is granted by this document or by any conduct of Vishay. Product names and markings noted herein may be trademarks of their respective owners.