

## Automotive ultrafast recovery diode

Datasheet - production data

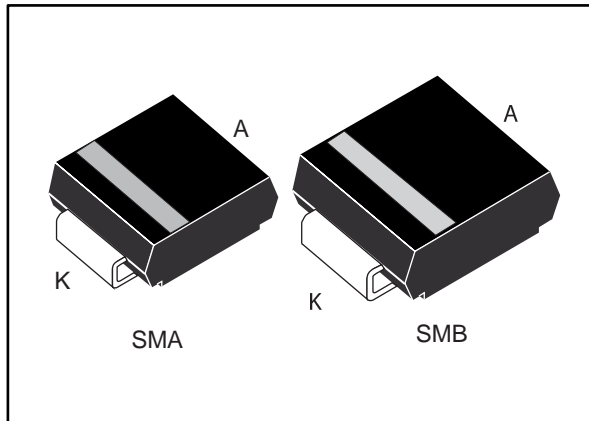

### Description

This device that uses ST's new 400 V planar Pt doping technology, is specially suited for switching mode base drive and transistor circuits.

Packaged in SMB and SMA, it is intended for use in low voltage, high frequency inverters, freewheeling and polarity protection in automotive applications.

**Table 1: Device summary**

Symbol	Value
$I_{F(AV)}$	1 A
$V_{RRM}$	400 V
$T_j$ (max.)	175 °C
$V_F$ (typ.)	0.9 V
$t_{rr}$ (typ.)	14 ns

### Features

- AEC-Q101 qualified 
- Negligible switching losses
- Low forward and reverse recovery times
- High junction temperature
- ECOPACK®2 compliant component

# 1 Characteristics

**Table 2: Absolute ratings (limiting values per diode at 25 °C, unless otherwise specified)**

Symbol	Parameter		Value	Unit	
V <sub>RRM</sub>	Repetitive peak reverse voltage		T <sub>j</sub> = -40 °C to +175 °C	400	V
I <sub>F(AV)</sub>	Average forward current, δ = 0.5, square wave	SMA	T <sub>I</sub> = 130 °C	1.0	A
		SMB	T <sub>I</sub> = 140 °C		
I <sub>FSM</sub>	Surge non repetitive forward current		t <sub>p</sub> = 10 ms sinusoidal	30	A
			t <sub>p</sub> = 8.3 ms sinusoidal	37	
T <sub>stg</sub>	Storage temperature range			-65 to +175	°C
T <sub>j</sub>	Operating junction temperature <sup>(1)</sup>			-40 to +175	°C

**Notes:**

<sup>(1)</sup>(dP<sub>tot</sub>/dT<sub>j</sub>) < (1/R<sub>th(j-a)</sub>) condition to avoid thermal runaway for a diode on its own heatsink.

**Table 3: Thermal resistance parameters**

Symbol	Parameter		Maximum value	Unit
R <sub>th(j-l)</sub>	Junction to lead	SMA	30	°C/W
		SMB	25	

**Table 4: Static electrical characteristics ( per diode)**

Symbol	Parameter	Test conditions		Min.	Typ.	Max.	Unit
I <sub>R</sub> <sup>(1)</sup>	Reverse leakage current	T <sub>j</sub> = 25 °C	V <sub>R</sub> = V <sub>RRM</sub>	-		5	μA
		T <sub>j</sub> = 125 °C		-	5	50	
V <sub>F</sub> <sup>(2)</sup>	Forward voltage drop	T <sub>j</sub> = 25 °C	I <sub>F</sub> = 1 A	-	1.30	1.60	V
		T <sub>j</sub> = 100 °C		-	1.05	1.30	
		T <sub>j</sub> = 150 °C		-	0.90	1.15	

**Notes:**

<sup>(1)</sup>Pulse test: t<sub>p</sub> = 5 ms, δ < 2%

<sup>(2)</sup>Pulse test: t<sub>p</sub> = 380 μs, δ < 2%

To evaluate the conduction losses, use the following equation:

$$P = 0.9 \times I_{F(AV)} + 0.250 \times I_{F(RMS)}^2$$

Table 5: Dynamic electrical characteristics per diode ( $T_j = 25\text{ °C}$ , unless otherwise specified)

Symbol	Parameters	Test conditions	Min.	Typ.	Max.	Unit
$t_{rr}$	Reverse recovery time	$I_F = 1\text{ A}$ $di_F/dt = -50\text{ A}/\mu\text{s}$ $V_R = 30\text{ V}$	-		30	ns
		$I_F = 1\text{ A}$ $di_F/dt = -100\text{ A}/\mu\text{s}$ $V_R = 30\text{ V}$	-	14	20	
$I_{RM}$	Reverse recovery current	$I_F = 1\text{ A}$ $di_F/dt = -200\text{ A}/\mu\text{s}$ $V_R = 320\text{ V}$ $T_j = 125\text{ °C}$	-	2.5	3.5	A
$V_{FP}$	Forward recovery voltage	$I_F = 1\text{ A}$ $di_F/dt = 100\text{ A}/\mu\text{s}$	-	2.9		V
$t_{fr}$	Forward recovery time	$I_F = 1\text{ A}$ $di_F/dt = 100\text{ A}/\mu\text{s}$ $V_{FR} = 1.1 \times V_F(\text{max})$	-		50	ns

# 1.1 Characteristics (curves)

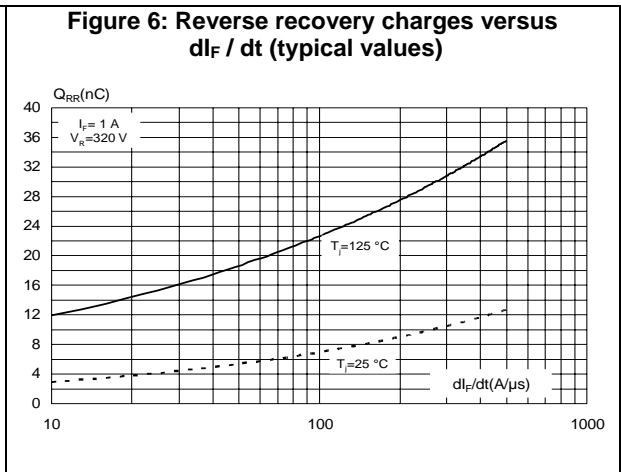
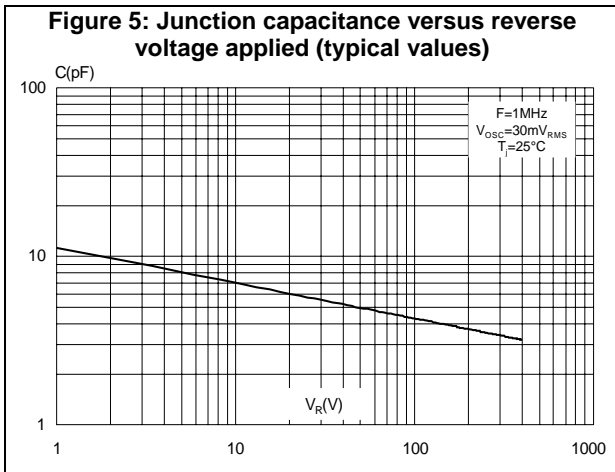
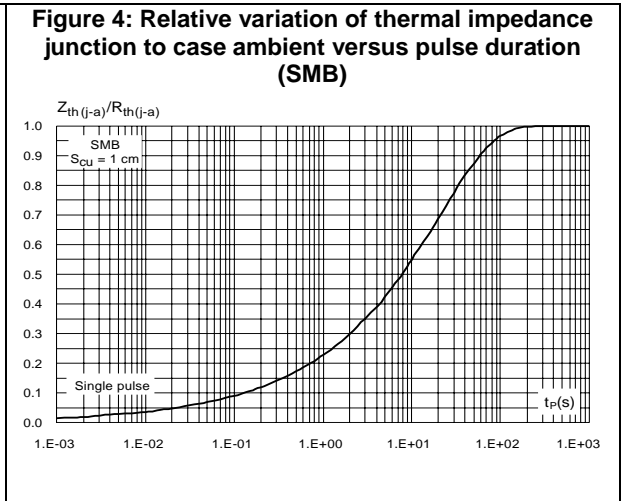
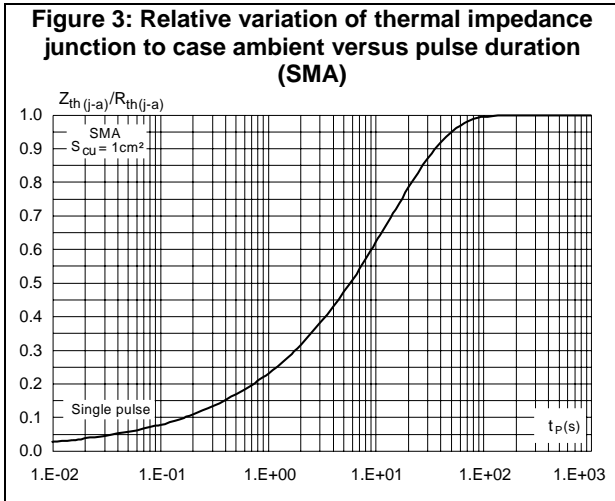
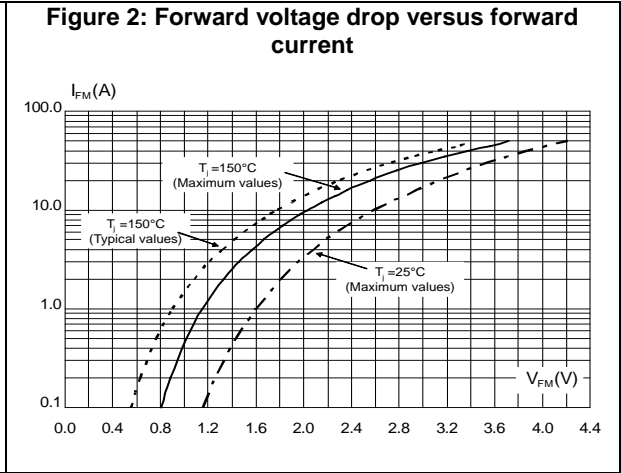
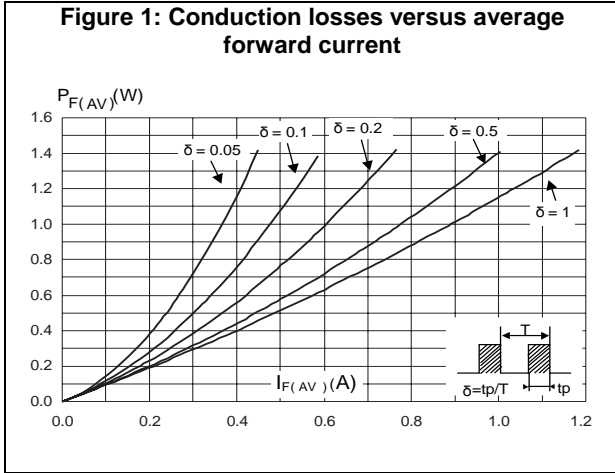

**Figure 7: Reverse recovery time versus  $di_F / dt$  (typical values)**

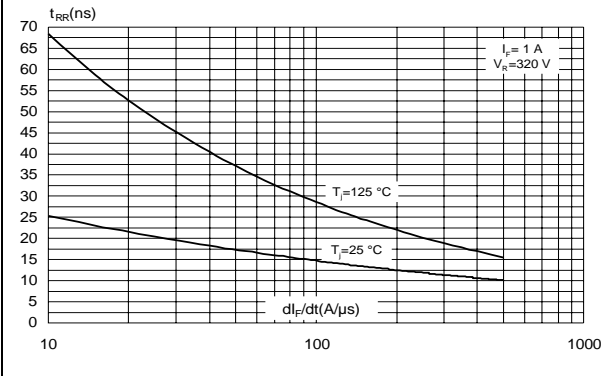

**Figure 8: Peak reverse recovery current versus  $di_F / dt$  (typical values)**

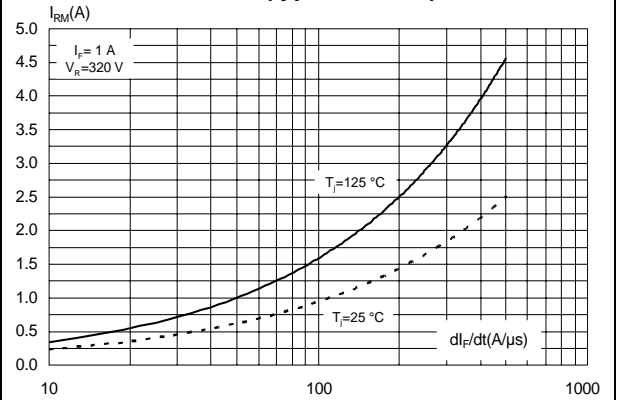

**Figure 9: Relative variation of dynamic parameters versus junction temperature**

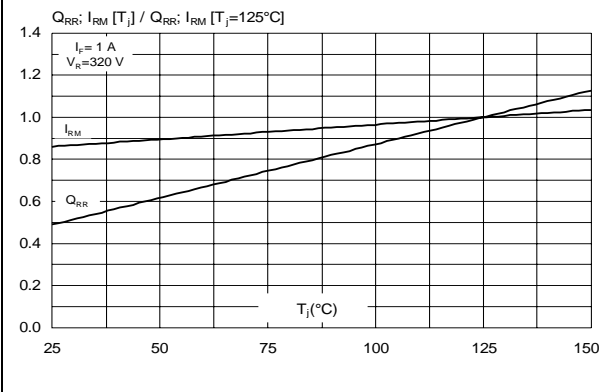

**Figure 10: Transient peak forward voltage versus  $di_F / dt$  (typical values)**

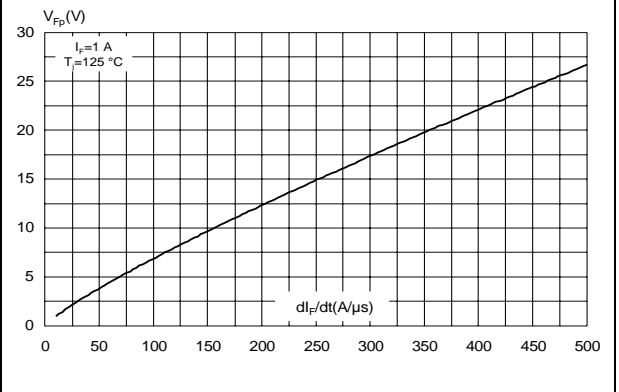

**Figure 11: Forward recovery time versus  $di_F / dt$  (typical values)**

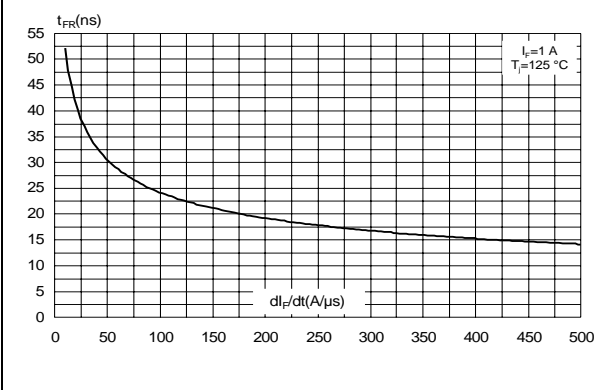

**Figure 12: Thermal resistance junction to ambient total versus copper surface under each lead (SMA)**

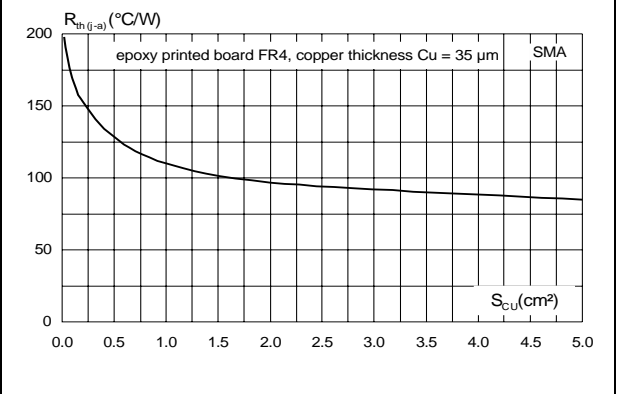

**Figure 13: Thermal resistance junction to ambient total versus copper surface under each lead (SMB)**

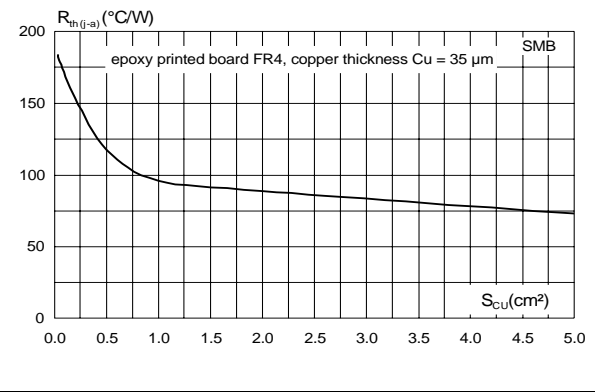

## 2 Package information

In order to meet environmental requirements, ST offers these devices in different grades of ECOPACK® packages, depending on their level of environmental compliance. ECOPACK® specifications, grade definitions and product status are available at: [www.st.com](http://www.st.com). ECOPACK® is an ST trademark.

### 2.1 SMA package information

Figure 14: SMA package outline

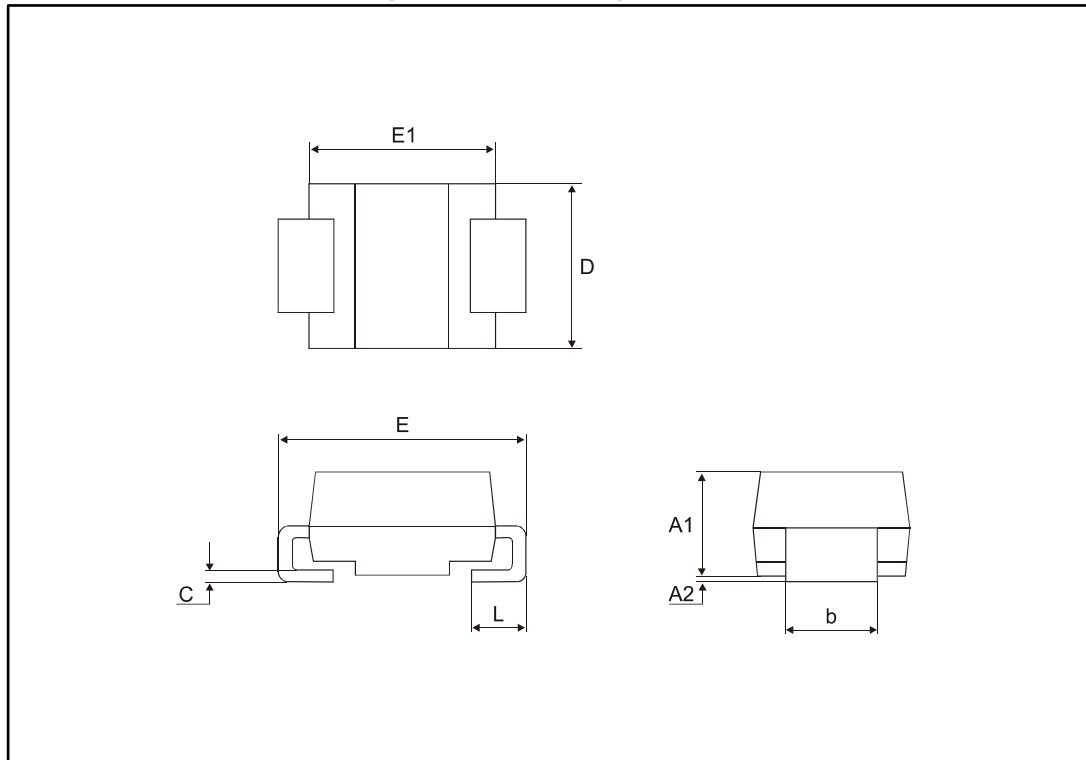
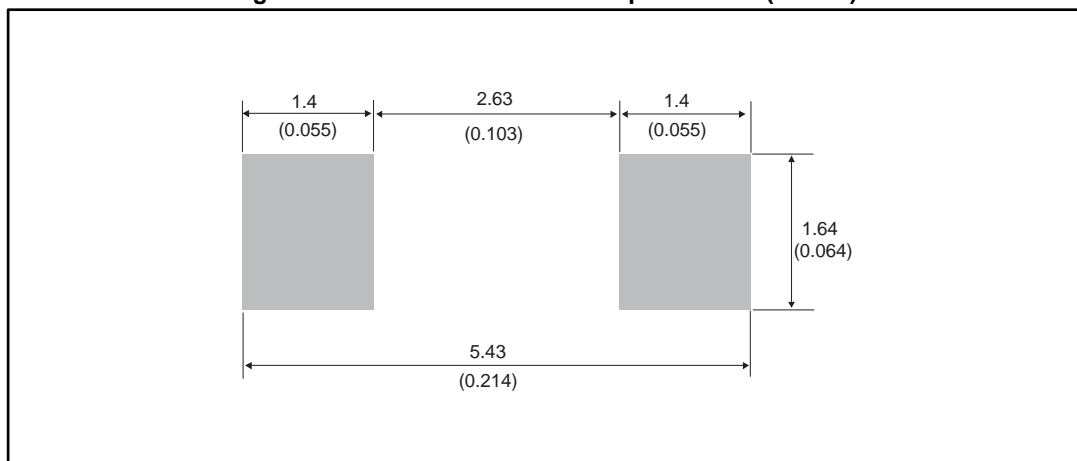

Table 6: SMA package mechanical data

Ref.	Dimensions			
	Millimeters		Inches	
	Min.	Max.	Min.	Max.
A1	1.90	2.45	0.075	0.097
A2	0.05	0.20	0.002	0.008
b	1.25	1.65	0.049	0.065
c	0.15	0.40	0.006	0.016
D	2.25	2.90	0.089	0.114
E	4.80	5.35	0.189	0.211
E1	3.95	4.60	0.156	0.181
L	0.75	1.50	0.030	0.059

Figure 15: SMA recommended footprint in mm (inches)





## 2.2 SMB package information

Figure 16: SMB package outline

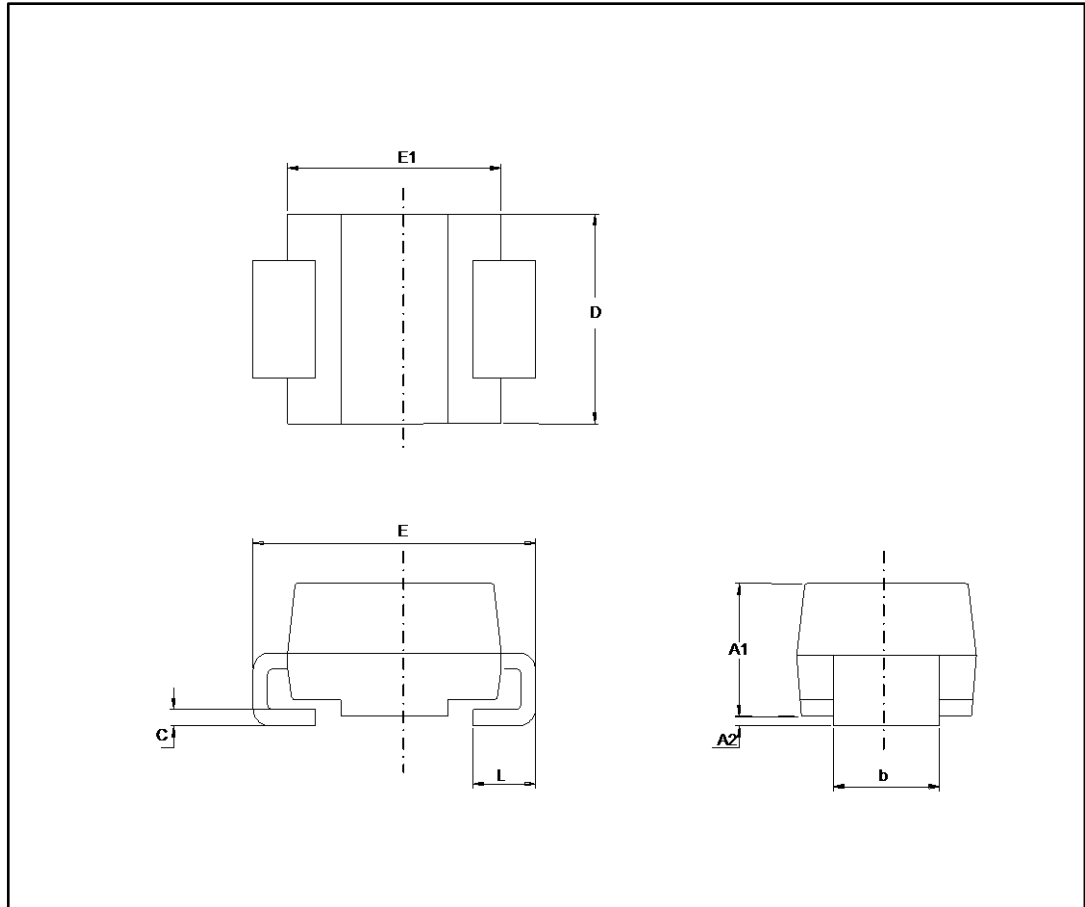
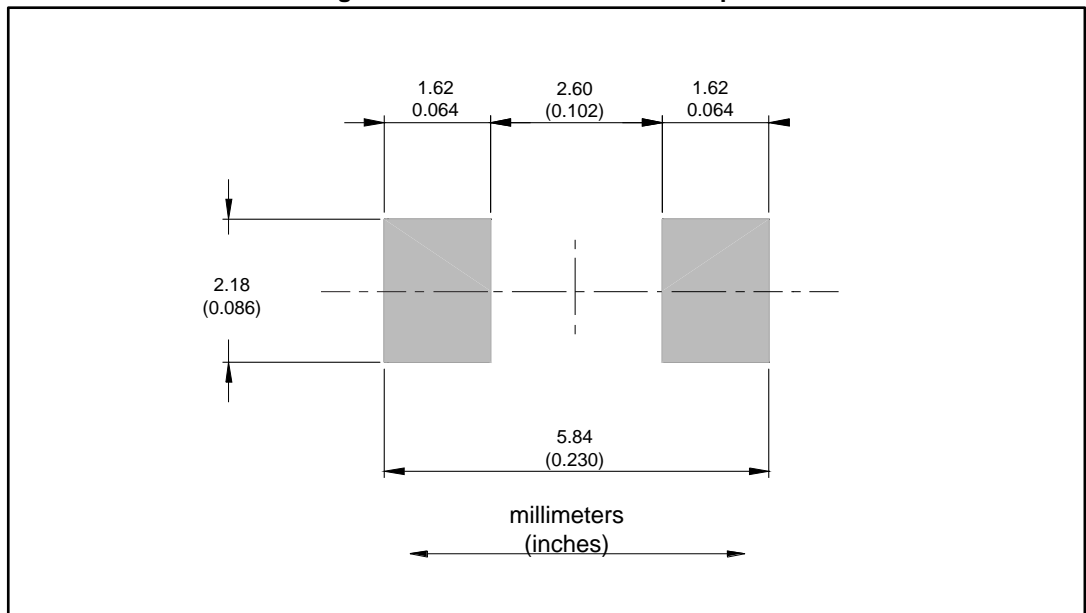

Table 7: SMB package mechanical data

Ref.	Dimensions			
	Millimeters		Inches	
	Min.	Max.	Min.	Max.
A1	1.90	2.45	0.0748	0.0965
A2	0.05	0.20	0.0020	0.0079
b	1.95	2.20	0.0768	0.0867
c	0.15	0.40	0.0059	0.0157
D	3.30	3.95	0.1299	0.1556
E	5.10	5.60	0.2008	0.2205
E1	4.05	4.60	0.1594	0.1811
L	0.75	1.50	0.0295	0.0591

Figure 17: SMB recommended Footprint



### 3 Ordering information

Table 8: Ordering information

Order code	Marking	Package	Weight	Base qty.	Delivery mode
STTH1R04AY	HR4Y	SMA	0.068 g	5000	Tape and reel
STTH1R04UY	BR4Y	SMB	0.12 g	2500	Tape and reel

### 4 Revision history

Table 9: Document revision history

Date	Revision	Changes
09-Jul-2013	1	First issue
16-Mar-2017	2	Updated <a href="#">Table 2: "Absolute ratings (limiting values per diode at 25 °C, unless otherwise specified)"</a> .

**IMPORTANT NOTICE – PLEASE READ CAREFULLY**

STMicroelectronics NV and its subsidiaries ("ST") reserve the right to make changes, corrections, enhancements, modifications, and improvements to ST products and/or to this document at any time without notice. Purchasers should obtain the latest relevant information on ST products before placing orders. ST products are sold pursuant to ST's terms and conditions of sale in place at the time of order acknowledgement.

Purchasers are solely responsible for the choice, selection, and use of ST products and ST assumes no liability for application assistance or the design of Purchasers' products.

No license, express or implied, to any intellectual property right is granted by ST herein.

Resale of ST products with provisions different from the information set forth herein shall void any warranty granted by ST for such product.

ST and the ST logo are trademarks of ST. All other product or service names are the property of their respective owners.

Information in this document supersedes and replaces information previously supplied in any prior versions of this document.

© 2017 STMicroelectronics – All rights reserved

# Mouser Electronics

Authorized Distributor

Click to View Pricing, Inventory, Delivery & Lifecycle Information:

[STMicroelectronics:](#)

[STTH1R04AY](#) [STTH1R04UY](#)