

LOC		DIST		REVISIONS			
ES	00	P	LTM	DESCRIPTION	DATE	DMN	APVD
	G2			ADDED THE DASH NO -27	11MAY2011	ML	SZ
	G3			REV PER ECR-13-006828	25APR2013	CZ	SZ
	G4			ADDED NEW DASH NUMBER 2-9	03JUN2013	CZ	SZ

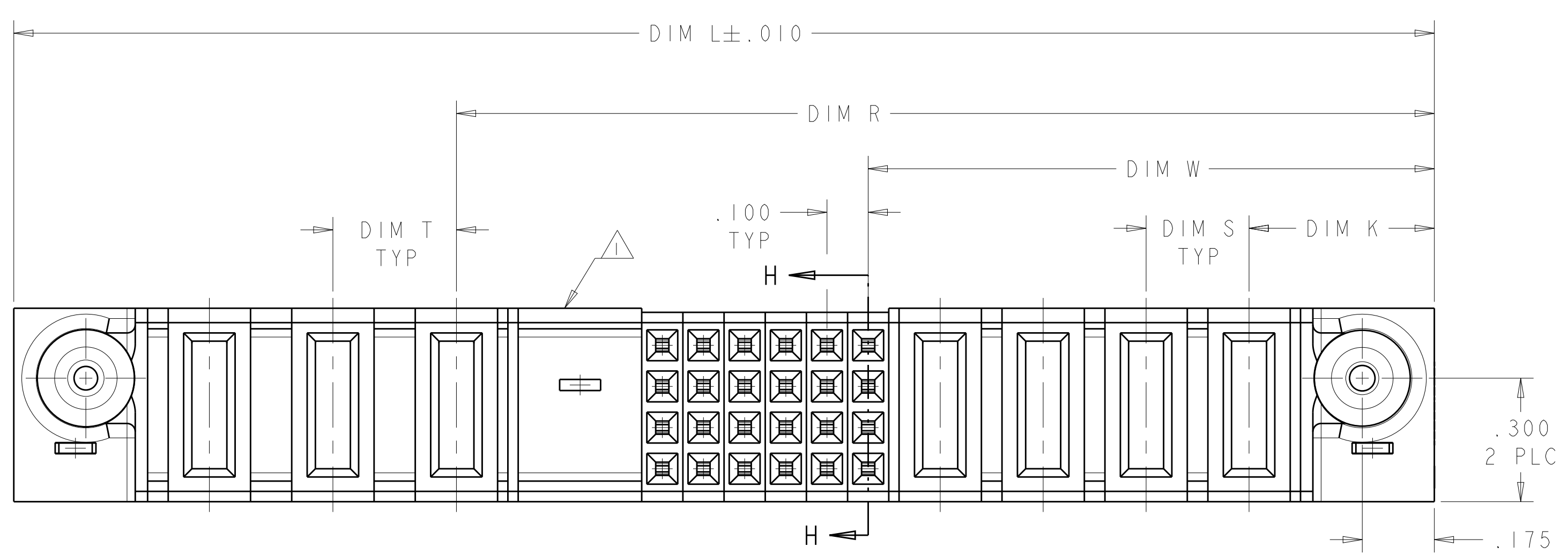

- △ OPTIONAL CENTER MODULE, WITH Ø.150 THRU HOLE OR HOLD DOWN FEATURE
- △ "AMP", TRADEMARK, PART NUMBER AND DATE CODE TO BE MARKED IN AREA SHOWN PARTS UNDER 2.00 LONG MAY BE MARKED ON BOTH SIDES
- △ MATERIAL: HOUSING - GLASS FILLED HIGH TEMP THERMO PLASTIC, UL94 V-0
 SIGNAL CONTACT - HIGH CONDUCTIVITY COPPER ALLOY
 POWER CONTACT - HIGH CONDUCTIVITY COPPER ALLOY
- △ CONTACT PLATING: NOBLE METAL PLATING ON CONTACT FUNCTIONAL AREA OF POWER AND SIGNAL CONTACTS
- △ MECHANICAL CONNECTOR KEEP OUT ZONE
- △ DATUM AND BASIC DIMENSIONS ESTABLISHED BY CUSTOMER
- △ PCB - ALL HOLE DIAMETERS ARE FINISHED HOLE SIZES
- △ PCB - .0453 ±.0010 DRILLED HOLES PLATED WITH .0003 MIN Sn OVER .001 TO .003 CU PLATING TO ACHIEVE A .040±.003 DIA HOLE
- △ FOR P/N:2-6450150-2.THE VARIABLE DIMENSIONS PLEASE SEE SHEET 7.

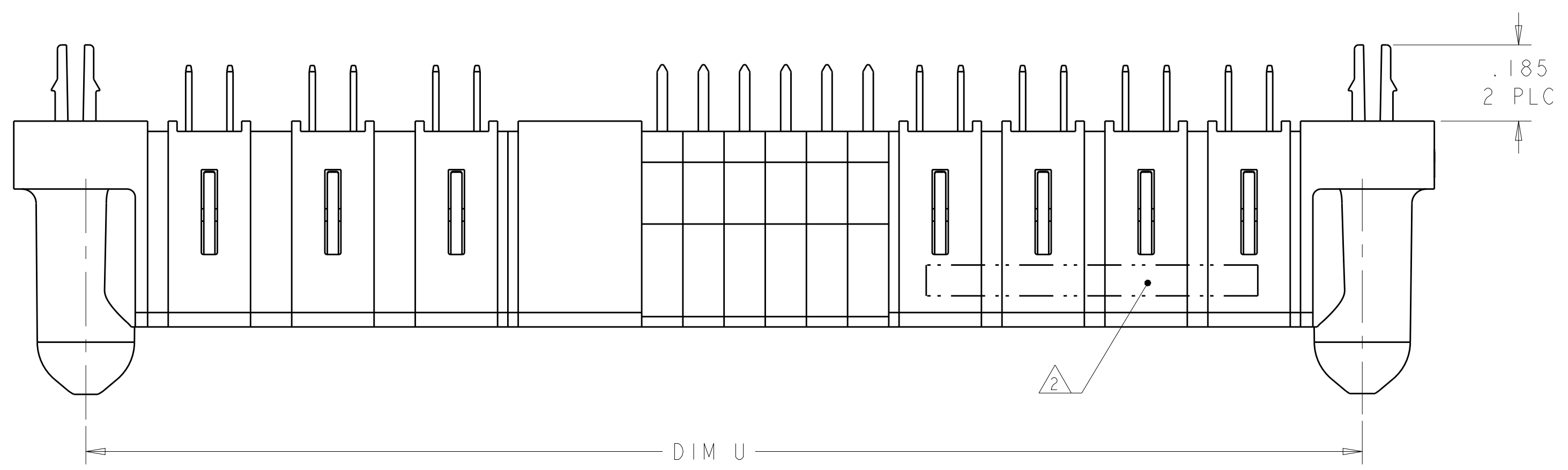
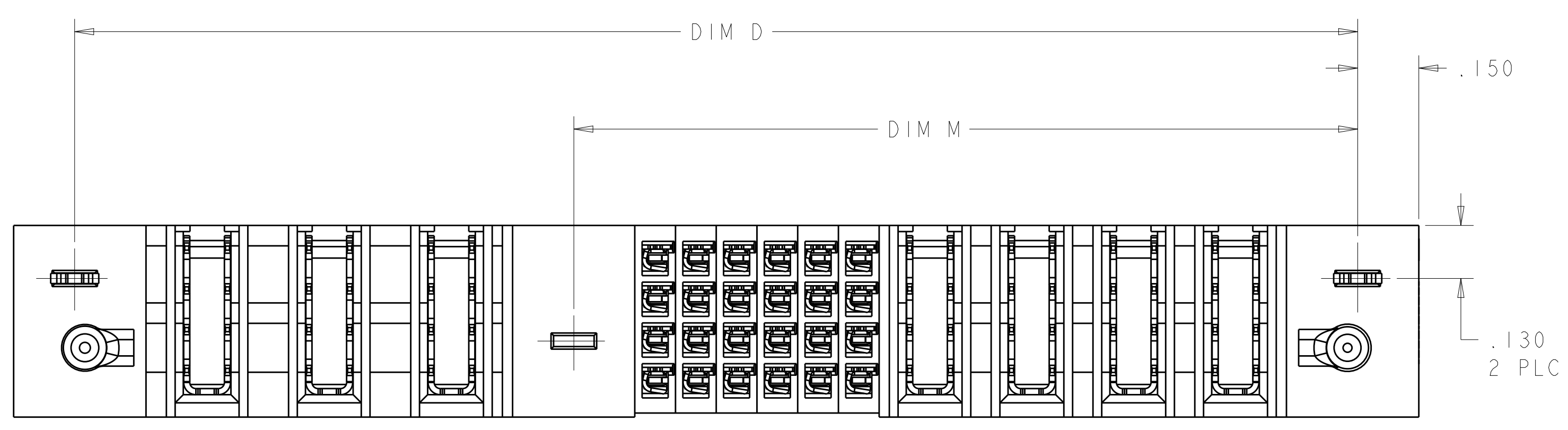
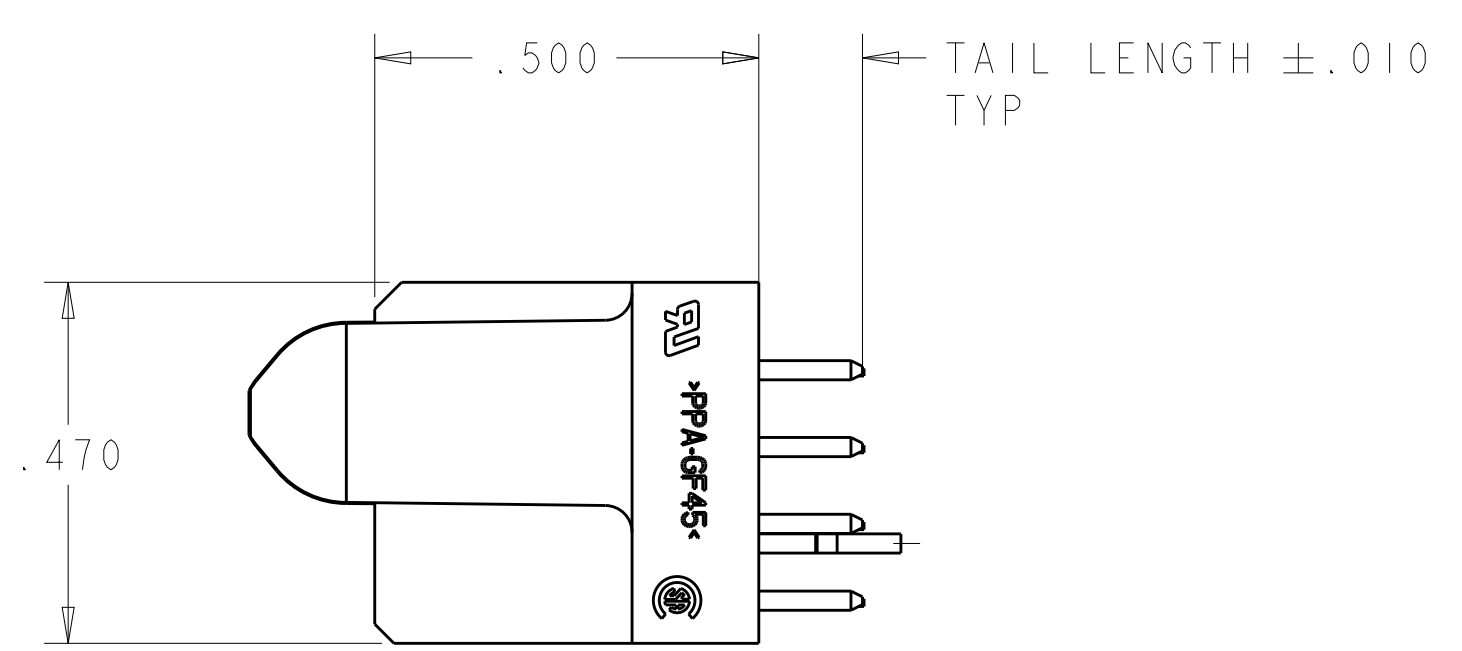
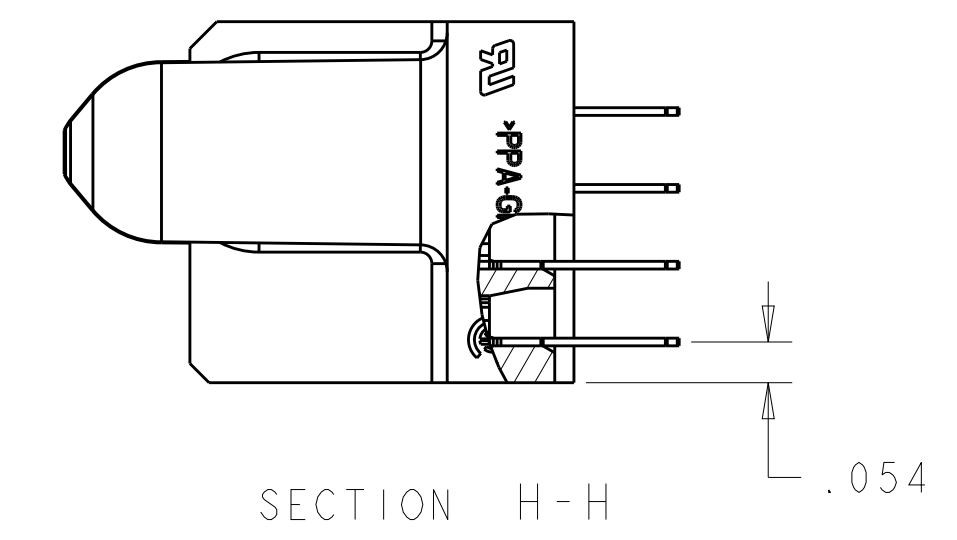

THIS DRAWING IS A CONTROLLED DOCUMENT.		DMN: R.GRZYBOWSKI 16FEB05	TE Connectivity
DIMENSIONS: INCHES		CHK: M.PERCHEKKE 16FEB05	
TOLERANCES UNLESS OTHERWISE SPECIFIED:		APVD: M.PERCHEKKE	NAME: VERTICAL RECEPTACLE ASSEMBLY WITH GUIDES MULTI-BEAM XL
0 PLC ±.01	1 PLC ±.01	PRODUCT SPEC: 108-1973	SIZE: A1
2 PLC ±.005	3 PLC ±.005	APPLICATION SPEC: 114-13038	CAGE CODE: 6450150
4 PLC ±.0020	ANGLES ±.7°	WEIGHT: -	RESTRICTED TO: -
MATERIAL: △3	FINISH: △4	CUSTOMER DRAWING	SCALE: 1:1 SHEET 1 OF 12 REV: G5

THIS DRAWING IS UNPUBLISHED. RELEASED FOR PUBLICATION 20
 © COPYRIGHT 20 BY - ALL RIGHTS RESERVED.

LOC	DIST	REVISIONS					
		P	LTN	DESCRIPTION	DATE	DWN	APVD
ES	00	-	-	SEE SHEET 1	-	-	-

WITH	2.650	.200	.250	1.550	.875	2.700	-	3.000	.450	2P + 24S + 6P	2-6450150-9
WITH	2.300	.250	.300	1.950	1.275	2.350	-	2.650	.475	3ACP + 24S + 2P	2-6450150-8
WITH	5.150	.300	.300	3.550	2.700	5.200	-	5.500	.450	8ACP + 32S + 6ACP	2-6450150-7
WITH	2.800	.300	.250	2.075	1.375	2.850	-	3.150	.450	4P + 24S + 3ACP	2-6450150-6
WITH	3.800	.300	.250	1.875	1.375	3.850	-	4.150	.450	4P + 16S + 7ACP	2-6450150-5
WITH	2.400	.200	.200	2.100	.825	2.450	-	2.750	.450	2P + 48S + 2P	2-6450150-4
WITH	1.700	.250	.250	1.350	.875	1.750	-	2.050	.450	2P + 16S + 2P	2-6450150-3
WITHOUT	5.500	.300	.300	3.175	2.525	5.550	-	5.850	.475	7ACP+20S+4ACP+5P	2-6450150-2
WITH	2.900	.250	.250	2.550	.875	2.950	-	3.250	.450	2P + 64S + 2P	2-6450150-1
WITH	3.550	-	.300	2.550	1.275	3.600	-	3.900	.475	3ACP + 48S + 5P	2-6450150-0
WITH	4.000	-	-	-	.375	4.050	-	4.350	-	148S	1-6450150-9
WITH	2.800	.250	.250	1.700	1.125	2.850	-	3.150	.450	3P + 20S + 5P	1-6450150-8
WITH	2.200	.250	.250	1.350	.875	2.250	-	2.550	.450	2P + 16S + 4P	1-6450150-7
WITH	3.500	.300	.250	2.775	2.375	3.550	-	3.850	.450	8P + 12S + 3ACP	1-6450150-3
WITH	2.300	.250	.300	1.950	1.275	2.350	-	2.650	.475	3ACP + 24S + 2P	6450150-9
WITH	1.575	-	-	1.425	.700	1.625	-	1.925	.475	1P + 24S + 1P	6450150-8
WITH	3.000	.250	.250	2.150	1.425	3.050	-	3.350	.450	4P + 24S + 4P	6450150-6
WITH	2.500	.300	.250	1.800	1.125	2.550	-	2.850	.450	3P + 24S + 3ACP	6450150-5
WITH	2.675	.200	.200	2.375	1.650	2.725	-	3.025	.475	5P + 24S + 2P	6450150-4
WITH	2.800	.300	.250	2.075	1.375	2.850	-	3.150	.450	4P + 24S + 3ACP	6450150-3
WITH	3.550	-	.300	2.550	1.275	3.600	-	3.900	.475	3ACP + 48S + 5P	6450150-2
WITH	4.350	.250	.250	3.500	2.625	4.400	-	4.700	.450	9P + 32S + 4P	6450150-1
HOLD DOWN	U	T	S	R	W	D	M	L	K	DESCRIPTION	PART NUMBER

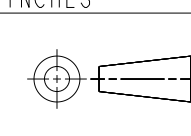
THIS DRAWING IS A CONTROLLED DOCUMENT.		OWN R. GRZYBOWSKI CHK M. PERCHERKE	16FEB05 16FEB05	 TE Connectivity
DIMENSIONS: INCHES		TOLERANCES UNLESS OTHERWISE SPECIFIED: 0 PLC ±. 2 PLC ±.01 3 PLC ±.005 4 PLC ±.0020 ANGLES ±.7°	APVD M. PERCHERKE	
		MATERIAL	PRODUCT SPEC 108-1973	APPLICATION SPEC 114-13038
FINISH		WEIGHT	SIZE A100779	CAGE CODE DRAWING NO 6450150
CUSTOMER DRAWING		SCALE 1:1	SHEET 2	OF 12
		REV G5		

PART NUMBER	ROWS	POWER (L)				SIGNAL								POWER (R)									
		P13	P12	P11	P10	8	7	6	5	4	3	2	1	P9	P8	P7	P6	P5	P4	P3	P2	P1	
6450150-1	D	VM	VM	VA	VM	E	E	E	E	E	E	E	E	E	E	E	E	E	E	E	E	VA	VM
	C	VM	VM	VA	VM	E	E	E	E	E	E	E	E	E	E	E	E	E	E	E	E	VA	VM
	B	VM	VM	VA	VM	E	E	E	E	E	E	E	E	E	E	E	E	E	E	E	E	VA	VM
	A	VM	VM	VA	VM	E	E	E	E	E	E	E	E	E	E	E	E	E	E	E	E	VA	VM

9P + 32S + 4P

PART NUMBER	ROWS	POWER (L)				SIGNAL												POWER (R)						
		P8	P7	P6	P5	P4	12	11	10	9	8	7	6	5	4	3	2	1	P3	P2	P1			
6450150-2	D	VM	VM	VM	VM	E	E	E	E	E	E	E	E	E	E	E	E	E	E	E	E	VA	VM	VM
	C	VM	VM	VM	VM	E	E	E	E	E	E	E	E	E	E	E	E	E	E	E	E	VA	VM	VM
	B	VM	VM	VM	VM	E	E	E	E	E	E	E	E	E	E	E	E	E	E	E	E	VA	VM	VM
	A	VM	VM	VM	VM	E	E	E	E	E	E	E	E	E	E	E	E	E	E	E	E	VA	VM	VM

3ACP + 48S + 5P

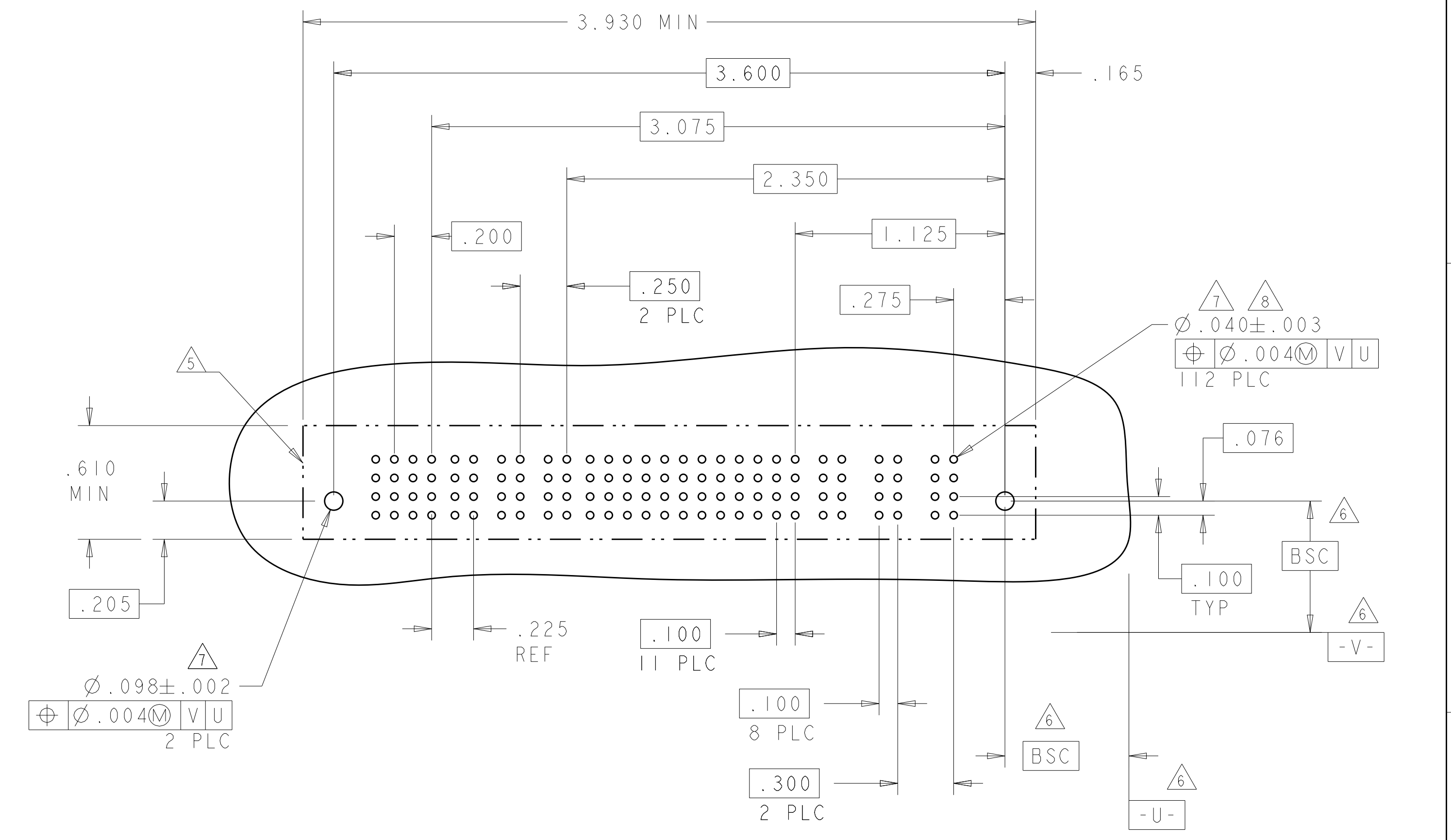
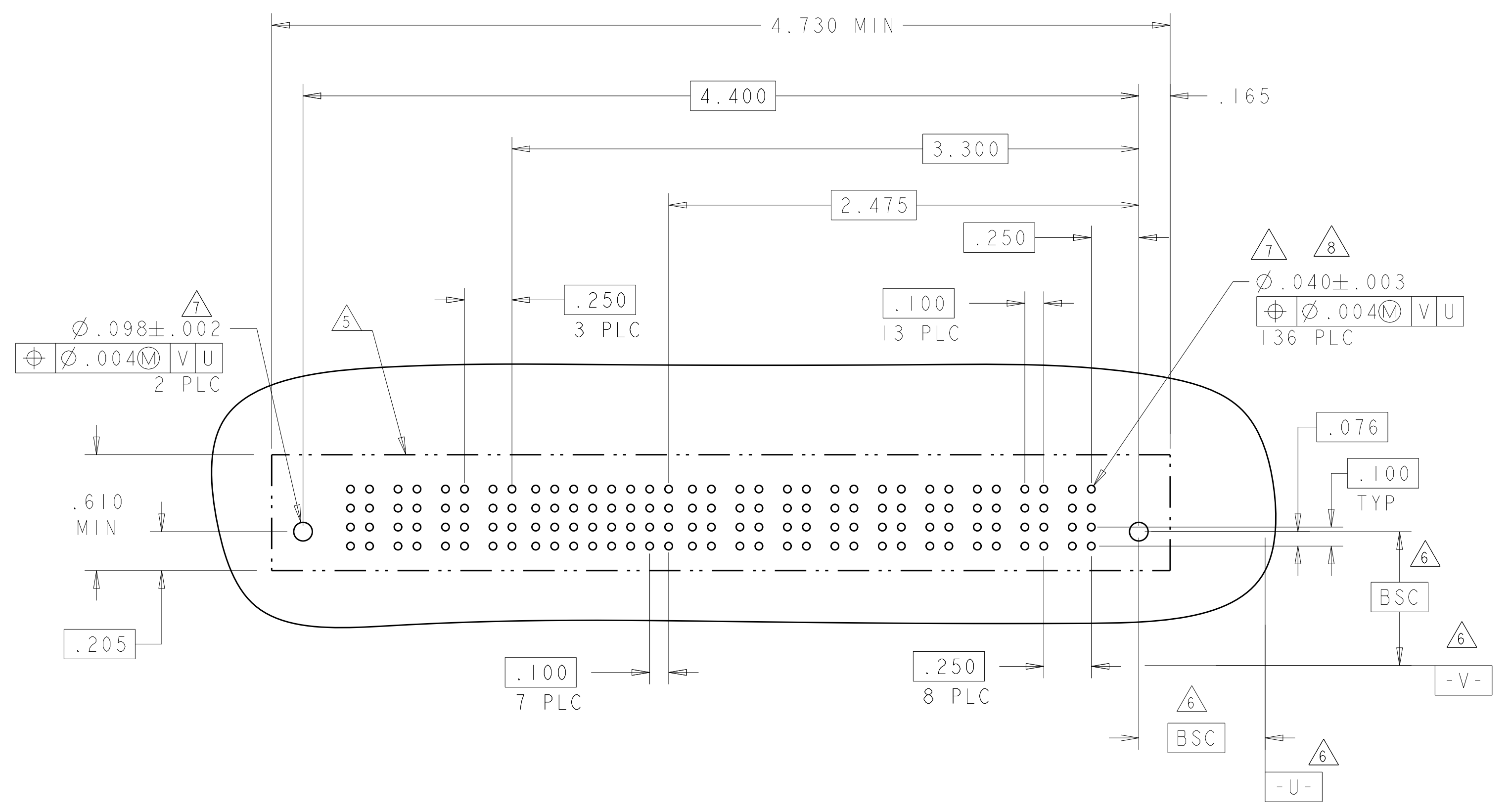

PART NUMBER	ROWS	POWER (L)			SIGNAL							POWER (R)				
		P7	P6	P5	6	5	4	3	2	1	P4	P3	P2	P1		
6450150-3	D	VM	VM	VA	E	E	E	E	E	E	E	E	E	VM	VM	VM
	C	VM	VM	VA	E	E	E	E	E	E	E	E	E	VM	VM	VM
	B	VM	VM	VA	E	E	E	E	E	E	E	E	E	VM	VM	VM
	A	VM	VM	VA	E	E	E	E	E	E	E	E	E	VM	VM	VM

4P + 24S + 3ACP

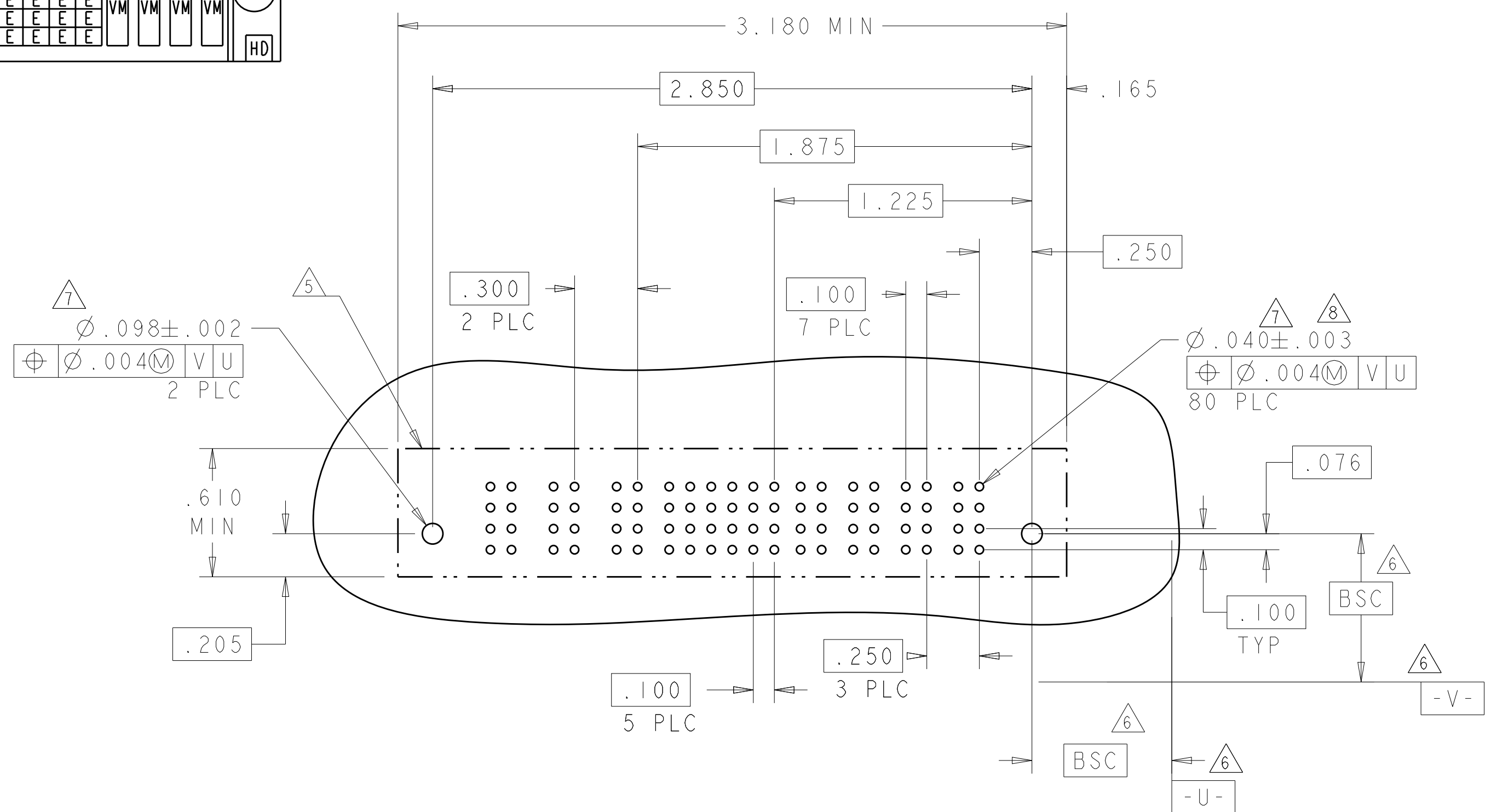

CODE	TAIL LENGTH	DESCRIPTION	CODE	TAIL LENGTH
VN	.090	STD		
VM	.135	STD		
VB	.090	MFBL	J	.090
VA	.135	MFBL	E	.135

POWER CONTACTS SIGNAL CONTACTS

THIS DRAWING IS A CONTROLLED DOCUMENT. DWN R.GRZYBOWSKI 16FEB05
 CHK M.PERCHEKKE 16FEB05
 APVD M.PERCHEKKE

DIMENSIONS: INCHES
 TOLERANCES UNLESS OTHERWISE SPECIFIED:
 0 PLC ±.
 1 PLC ±.01
 2 PLC ±.01
 3 PLC ±.005
 4 PLC ±.002
 ANGLES ±.2°

MATERIAL: - FINISH: - WEIGHT: -

CUSTOMER DRAWING

NAME: VERTICAL RECEPTACLE ASSEMBLY WITH GUIDES MULTI-BEAM XL
 PRODUCT SPEC: 108-1973
 APPLICATION SPEC: 114-13038
 SIZE: A1 CAGE CODE: 6450150 DRAWING NO: 100779
 SCALE: 1:1 SHEET 3 OF 12 REV: G5

PART NUMBER	ROWS	POWER (L)						SIGNAL						POWER (R)							
		P7	P6	6	5	4	3	2	1	P5	P4	P3	P2	P1	P1	P2	P3	P4	P5	P6	P7
6450150-4	D							J	J	J	J	J	J	VN	VN	VN	VN				
	C							J	J	J	J	J	J	VN	VN	VN	VN				
	B							J	J	J	J	J	J	VN	VN	VN	VN				
		HD																		HD	
5P + 24S + 2P																					

PART NUMBER	ROWS	POWER (L)						SIGNAL						POWER (R)							
		P8	P7	P6	P5	6	5	4	3	2	1	P4	P3	P2	P1	P1	P2	P3	P4	P5	P6
6450150-6	D							J	J	J	J	J	J	VN	VN	VN	VN				
	C							J	J	J	J	J	J	VN	VN	VN	VN				
	B							J	J	J	J	J	J	VN	VN	VN	VN				
		HD																		HD	
4P + 24S + 4P																					

NO CONTACT
LOADED

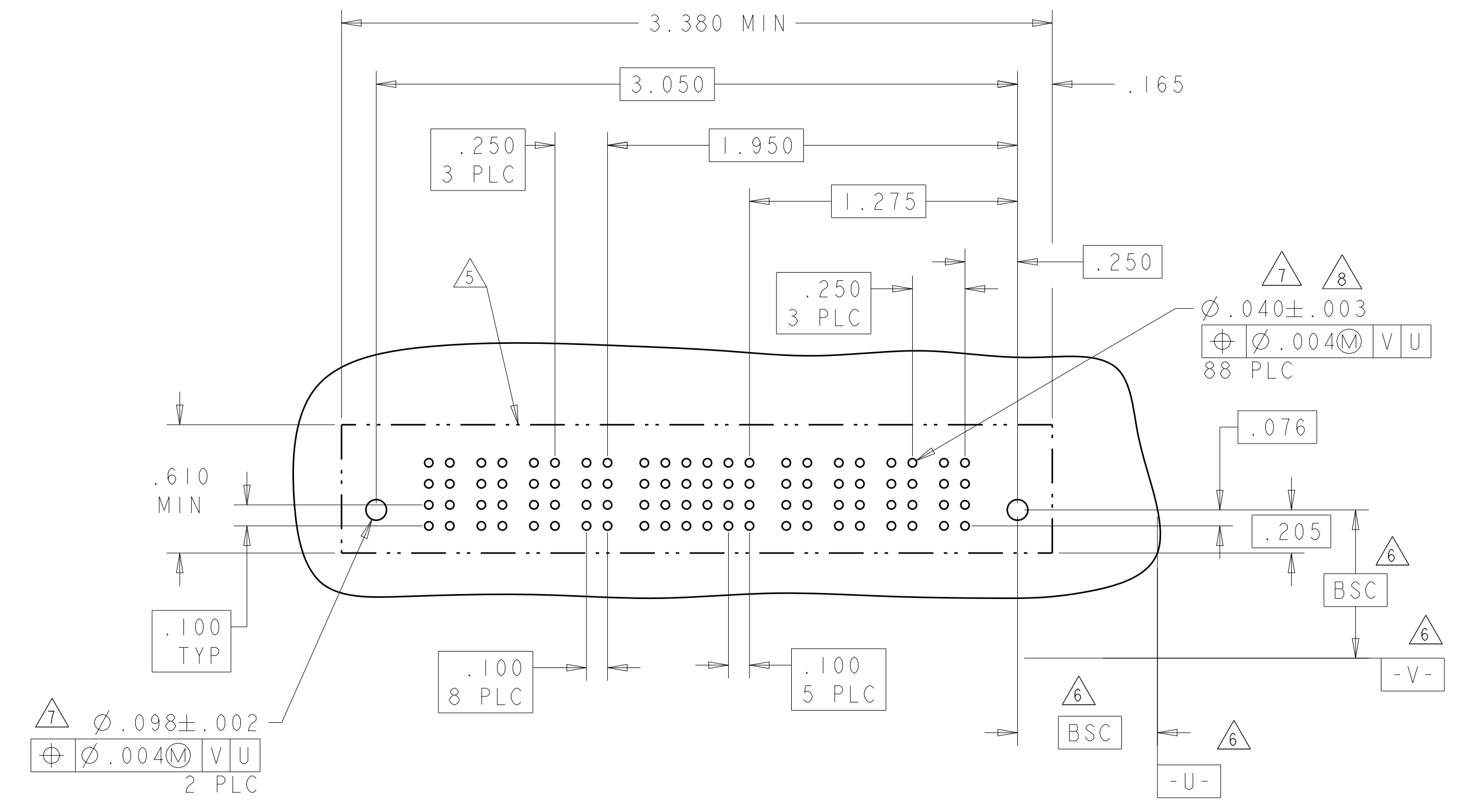
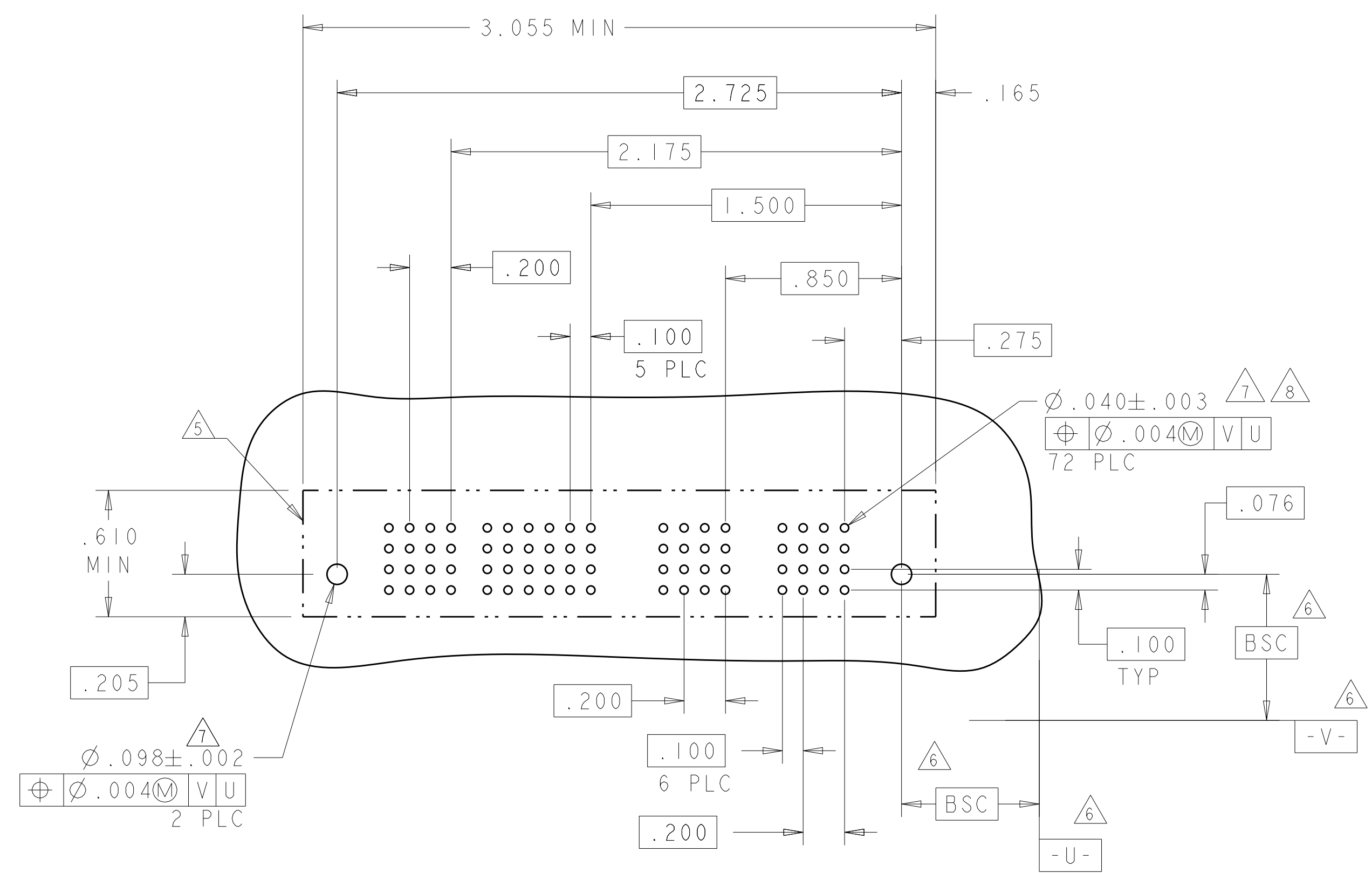

PART NUMBER	ROWS	POWER (L)						SIGNAL						POWER (R)							
		P6	P5	P4	6	5	4	3	2	1	P3	P2	P1	P1	P2	P3	P4	P5	P6	P7	P8
6450150-5	D							E	E	E	E	E	E	VM	VM	VM	VM				
	C							E	E	E	E	E	E	VM	VM	VM	VM				
	B							E	E	E	E	E	E	VM	VM	VM	VM				
		HD																		HD	
3P + 24S + 3ACP																					

PART NUMBER	ROWS	POWER (L)						SIGNAL						POWER (R)							
		P2	6	5	4	3	2	1	P1	P1	P2	P3	P4	P5	P6	P7	P8				
6450150-8	D							E	E	E	E	E	E	VM	VM	VM	VM				
	C							E	E	E	E	E	E	VM	VM	VM	VM				
	B							E	E	E	E	E	E	VM	VM	VM	VM				
		HD																		HD	
1P + 24S + 1P																					

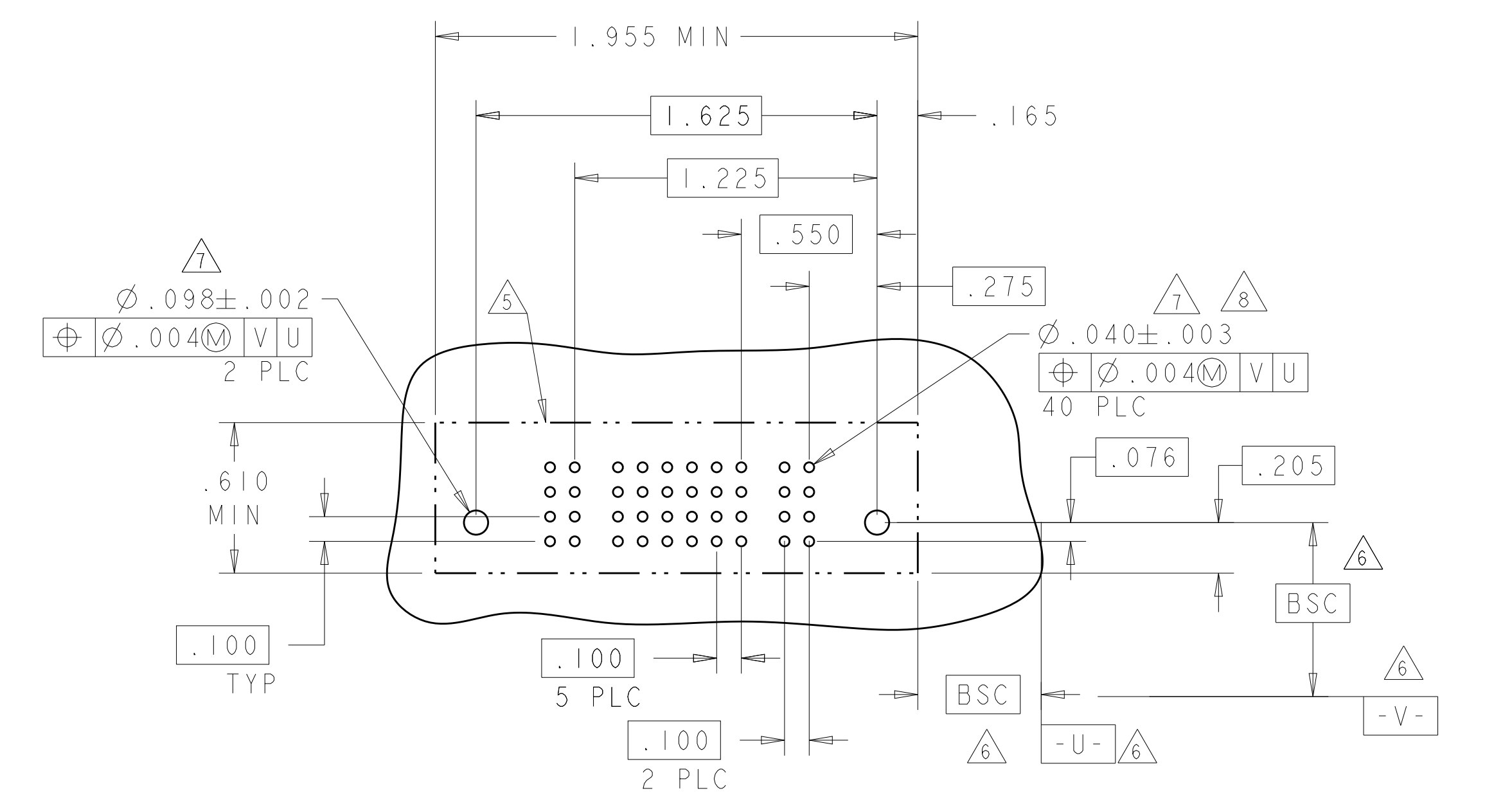
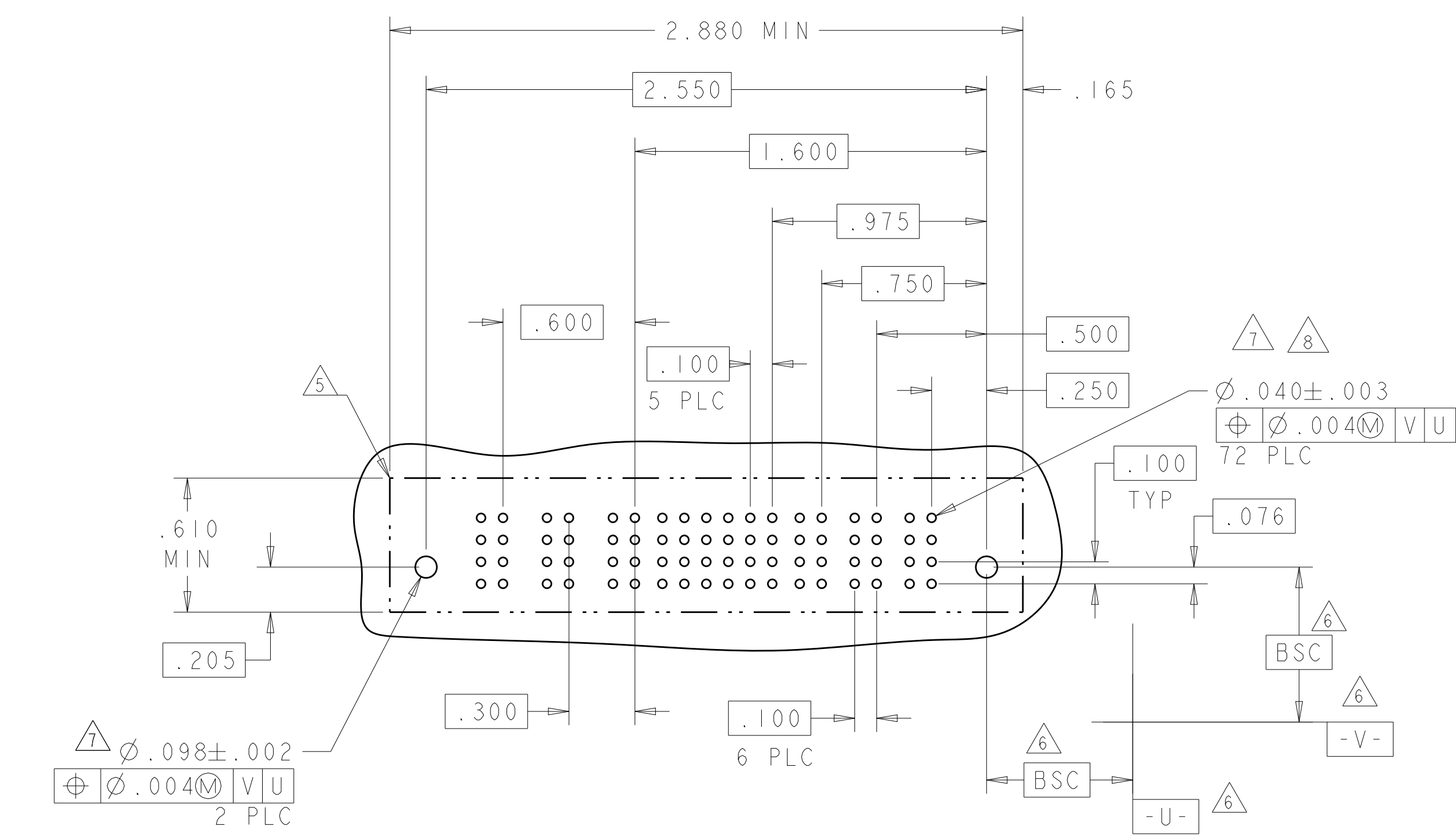

THIS DRAWING IS A CONTROLLED DOCUMENT.		OWN: R. GRZYBOWSKI 16FEB05	 TE Connectivity
DIMENSIONS: INCHES		CHK: M. PERCHERKE 16FEB05	
TOLERANCES UNLESS OTHERWISE SPECIFIED:		APVD: M. PERCHERKE	NAME: VERTICAL RECEPTACLE ASSEMBLY WITH GUIDES MULTI-BEAM XL
0 PLC ±.01		PRODUCT SPEC: 108-1973	SIZE: A1
1 PLC ±.01		APPLICATION SPEC: 114-13038	CAGE CODE: 100779
2 PLC ±.01		WEIGHT: .114-13038	DRAWING NO: 6450150
3 PLC ±.01		CUSTOMER DRAWING	SCALE: 1:1
4 PLC ±.002			SHEET 4 OF 12
ANGLES ±.002			REV: G5

PART NUMBER	ROWS	POWER (L)			SIGNAL								POWER			
		P11	P10	P9	3	2	1	P8	P7	P6	P5	P4	P3	P2	P1	
I-6450150-3	D	VM	VM	VA	E	E	E	E	E	E	E	E	E	E	E	
	C	VM	VM	VA	E	E	E	E	E	E	E	E	E	E	E	
	B	VM	VM	VA	E	E	E	E	E	E	E	E	E	E	E	
A		HD														

8P + 12S + 3ACP

PART NUMBER	ROWS	POWER (L)					SIGNAL					POWER (R)			
		P8	P7	P6	P5	P4	5	4	3	2	1	P3	P2	P1	
I-6450150-8	D	VA	VA	VM	VA	VA	E	E	E	E	E	VM	VM	VM	
	C	VA	VA	VM	VA	VA	E	E	E	E	E	VM	VM	VM	
	B	VA	VA	VM	VA	VA	E	E	E	E	E	VM	VM	VM	
A		HD													

3P + 20S + 5P

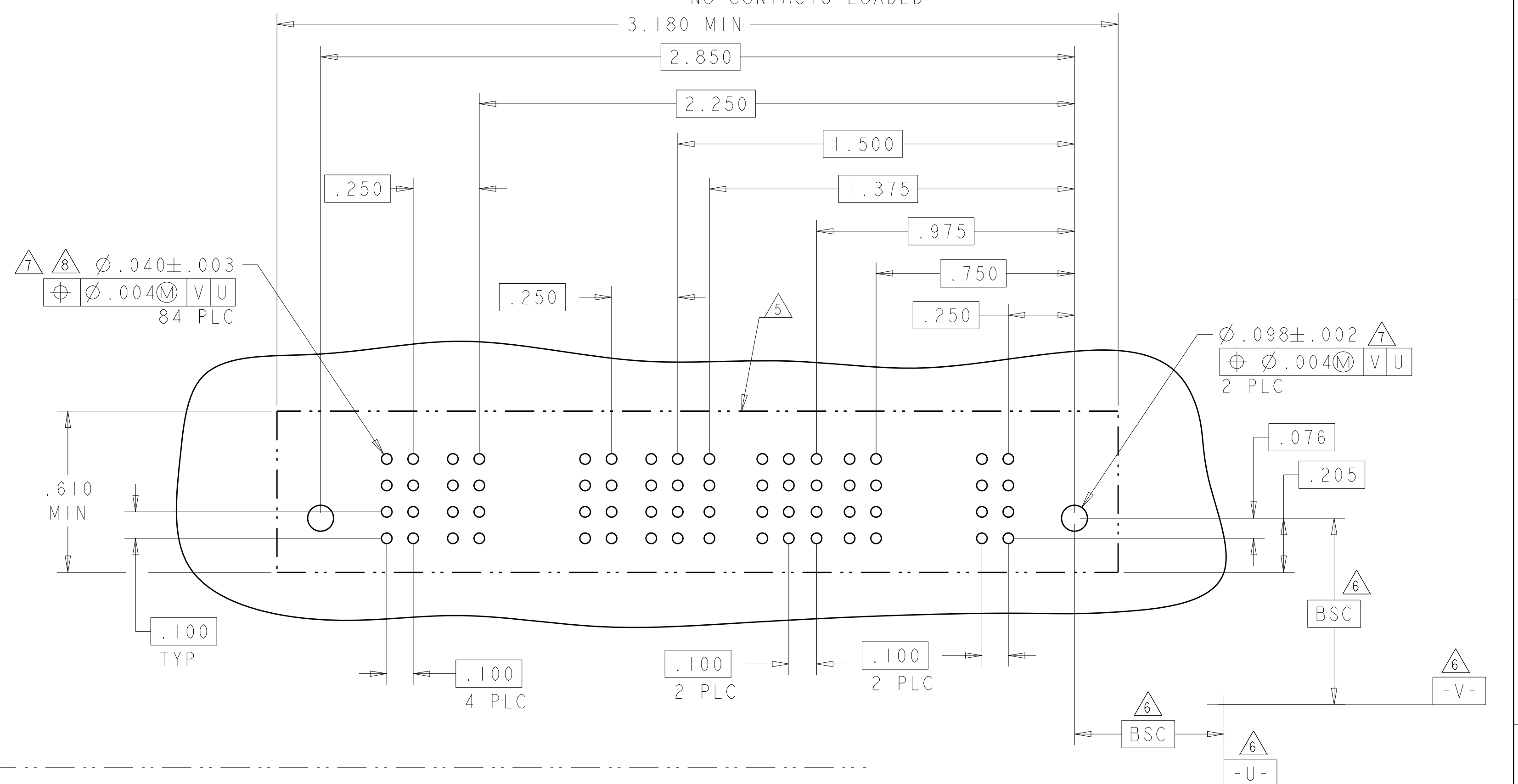
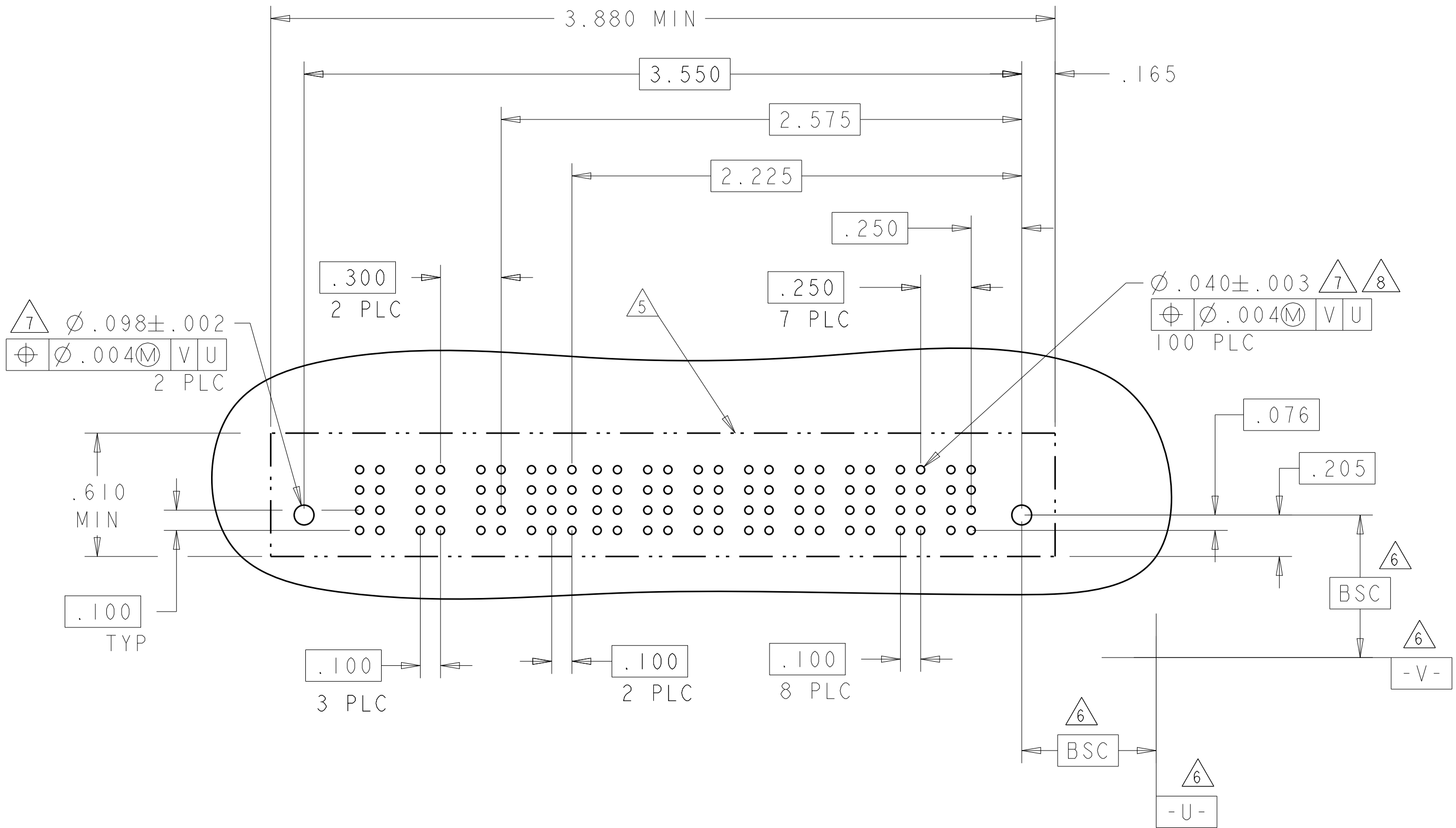

PART NUMBER	ROWS	SIGNAL																																					
		37	36	35	34	33	32	31	30	29	28	27	26	25	24	23	22	21	20	19	18	17	16	15	14	13	12	11	10	9	8	7	6	5	4	3	2	1	
I-6450150-9	D	E	E	E	E	E	E	E	E	E	E	E	E	E	E	E	E	E	E	E	E	E	E	E	E	E	E	E	E	E	E	E	E	E	E	E	E	E	
	C	E	E	E	E	E	E	E	E	E	E	E	E	E	E	E	E	E	E	E	E	E	E	E	E	E	E	E	E	E	E	E	E	E	E	E	E	E	E
	B	E	E	E	E	E	E	E	E	E	E	E	E	E	E	E	E	E	E	E	E	E	E	E	E	E	E	E	E	E	E	E	E	E	E	E	E	E	E
A		HD																																					

148S

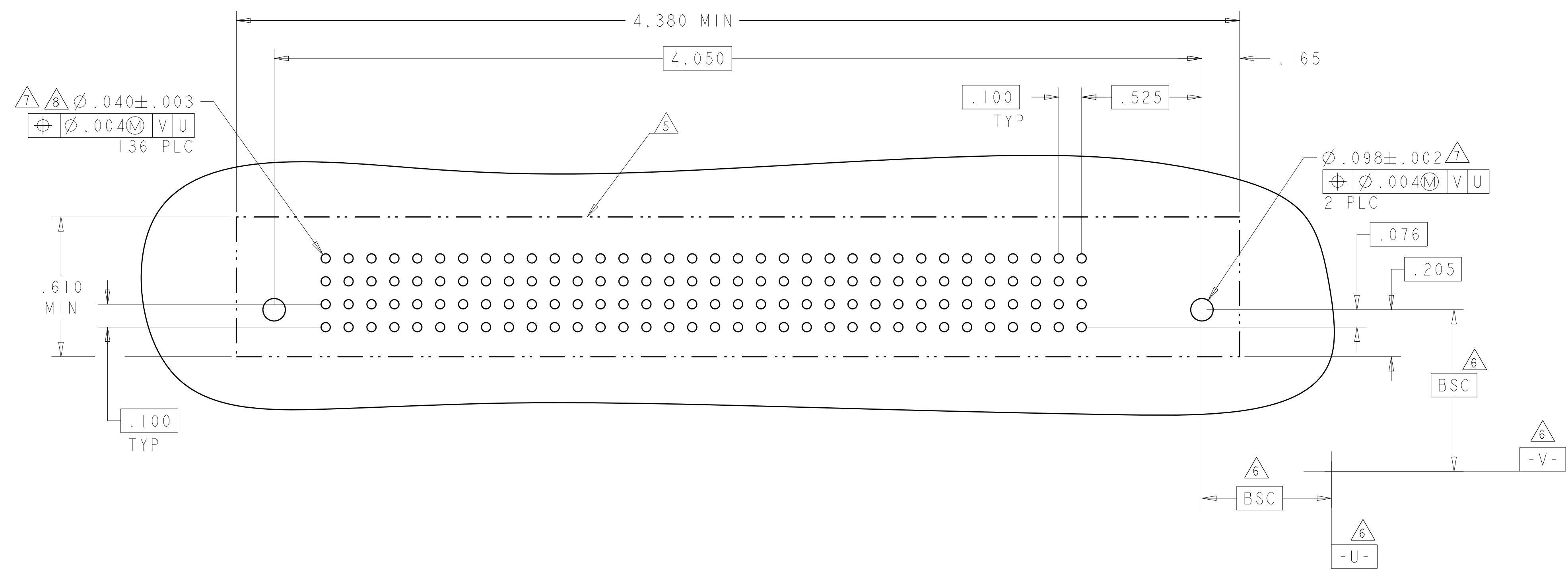

THIS DRAWING IS A CONTROLLED DOCUMENT.		DWN: R. GRZYBOWSKI 16FEB05		TE Connectivity
DIMENSIONS: INCHES		CHK: M. PERCHERKE 16FEB05		NAME: VERTICAL RECEPTACLE ASSEMBLY WITH GUIDES MULTI-BEAM XL
TOLERANCES UNLESS OTHERWISE SPECIFIED:		APVD: M. PERCHERKE	PRODUCT SPEC: 108-1973	
0 PLC ±.01		PRODUCT SPEC: 114-13038	APPLICATION SPEC: 114-13038	
1 PLC ±.01		SIZE: A1	CAGE CODE: 6450150	
2 PLC ±.01		WEIGHT: -	SCALE: 1:1	
3 PLC ±.005		CUSTOMER DRAWING	SHEET 5 OF 12	
4 PLC ±.002			REV G5	
ANGLES: .0020				

LOC	DIST	REVISIONS			
P	LTN	DESCRIPTION	DATE	DMN	APVD
ES	00	SEE SHEET 1	-	-	-

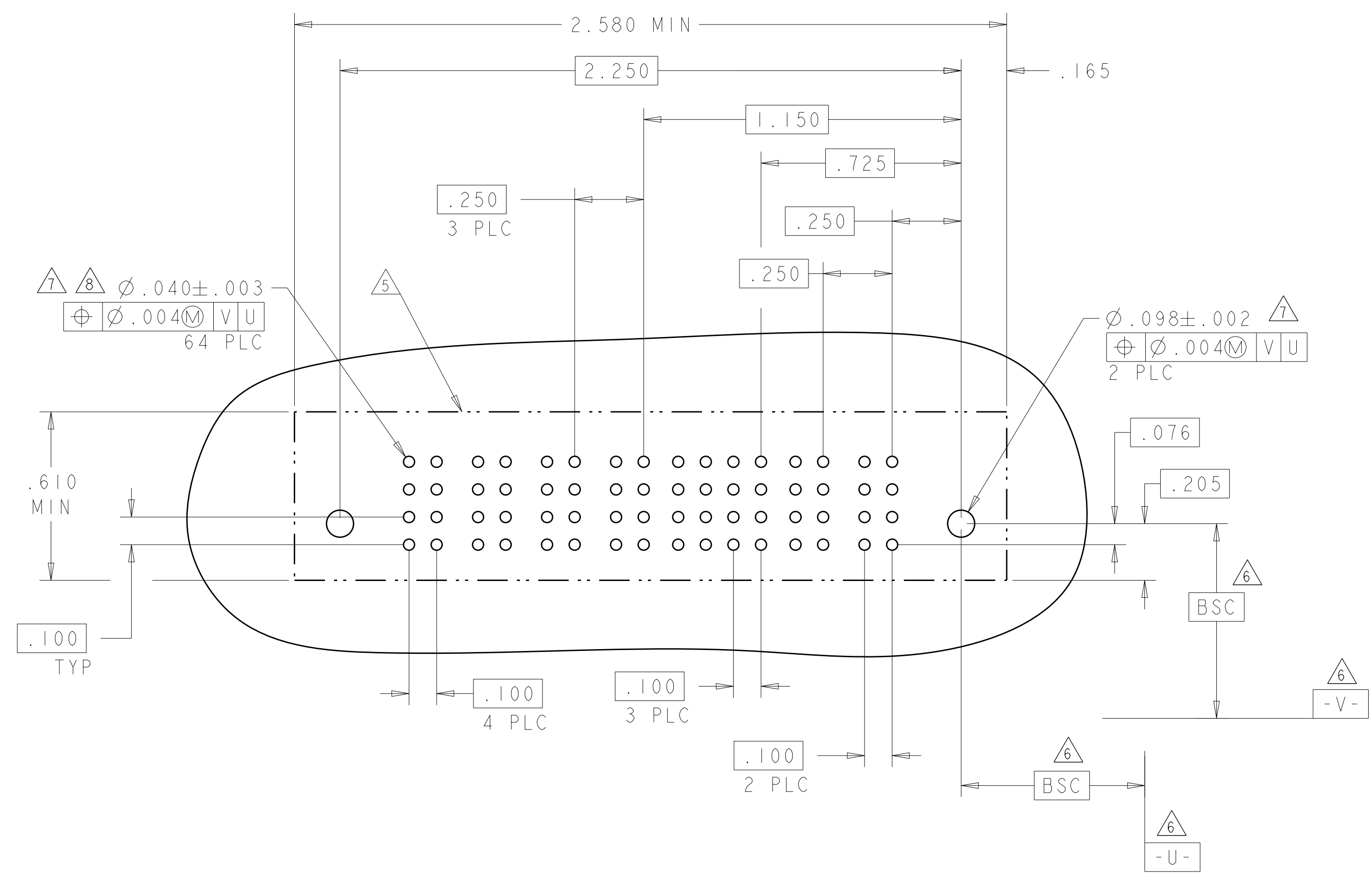

PART NUMBER	ROWS	POWER				SIGNAL				POWER		
		P6	P5	P4	P3	4	3	2	1	P2	P1	
1-6450150-7	D	VM	VM	VA	VA	E	E	E	E	VA	VM	
	C					E	E	E	E			
	B					E	E	E	E			
2P + 16S + 4P												HD

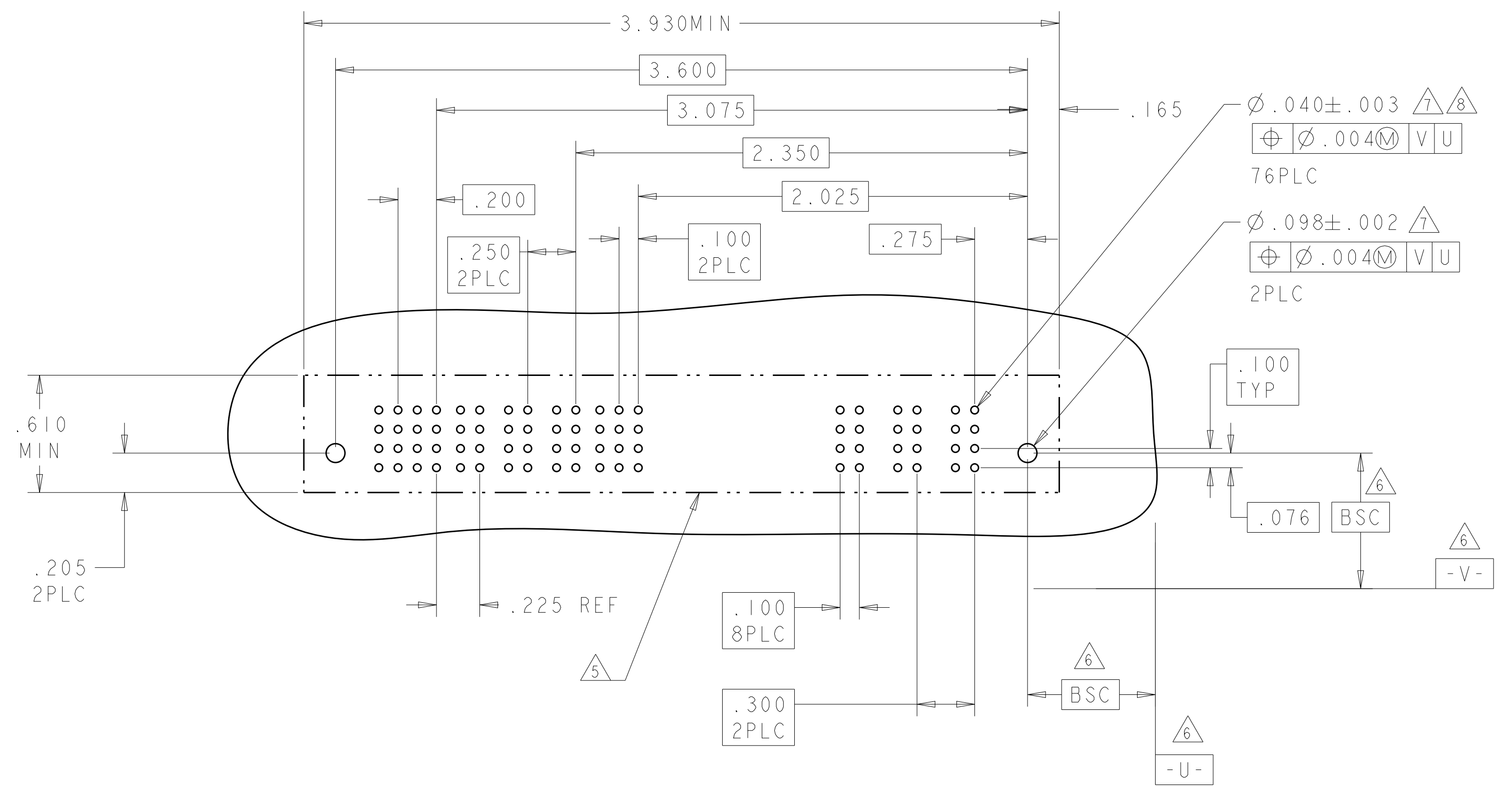

PART NUMBER	ROWS	POWER (L)								SIGNAL								POWER (R)				
		P8	P7	P6	P5	P4	I2	I1	I0	9	8	7	6	5	4	3	2	1	P3	P2		P1
2-6450150-0	D	VM	VM	VM	VM	VM	E	E	E	E	E	E	E	E	E	E	E	E	VA	VM	VM	
	C						E	E	E	E	E	E	E	E	E	E	E					
	B						E	E	E	E	E	E	E	E	E	E	E					
3ACP + 48S + 5P												NO CONTACTS LOADED										HD

THIS DRAWING IS A CONTROLLED DOCUMENT. DWN: R. GRZYBOWSKI 16FEB05
 CHK: M. PERCHERKE 16FEB05
 APVD: M. PERCHERKE

DIMENSIONS: INCHES
 TOLERANCES UNLESS OTHERWISE SPECIFIED:
 0 PLC ±.
 1 PLC ±.01
 2 PLC ±.01
 3 PLC ±.005
 4 PLC ±.0020
 ANGLES ±.2°

MATERIAL: - FINISH: -

WEIGHT: -

CUSTOMER DRAWING

NAME: VERTICAL RECEPTACLE ASSEMBLY WITH GUIDES MULTI-BEAM XL
 PRODUCT SPEC: 108-1973
 APPLICATION SPEC: 114-13038

SIZE: A1 CAGE CODE: 6450150 DRAWING NO: 00779
 RESTRICTED TO: -

SCALE: 1:1 SHEET: 6 OF 12 REV: G5

LOC		DIST		REVISIONS			
ES	00	P	LTN	DESCRIPTION	DATE	DWN	APVD
-	-	-	-	SEE SHEET 1	-	-	-

NO CONTACTS LOADED

PART NUMBER	ROWS	POWER (L)								SIGNAL					POWER (R)							
		P16	P15	P14	P13	P12	P11	P10	P9	P8	5	4	3	2	1	P7	P6	P5	P4	P3	P2	P1
2-6450150-2	D C B A	VA		VM		VM	VM	VM	VM	VM	E	E	E	E	E	VM	VM	VM	VM	VM	VM	VM
											E	E	E	E	E							
											E	E	E	E	E							
											E	E	E	E	E							

7ACP+20S+4ACP+5P

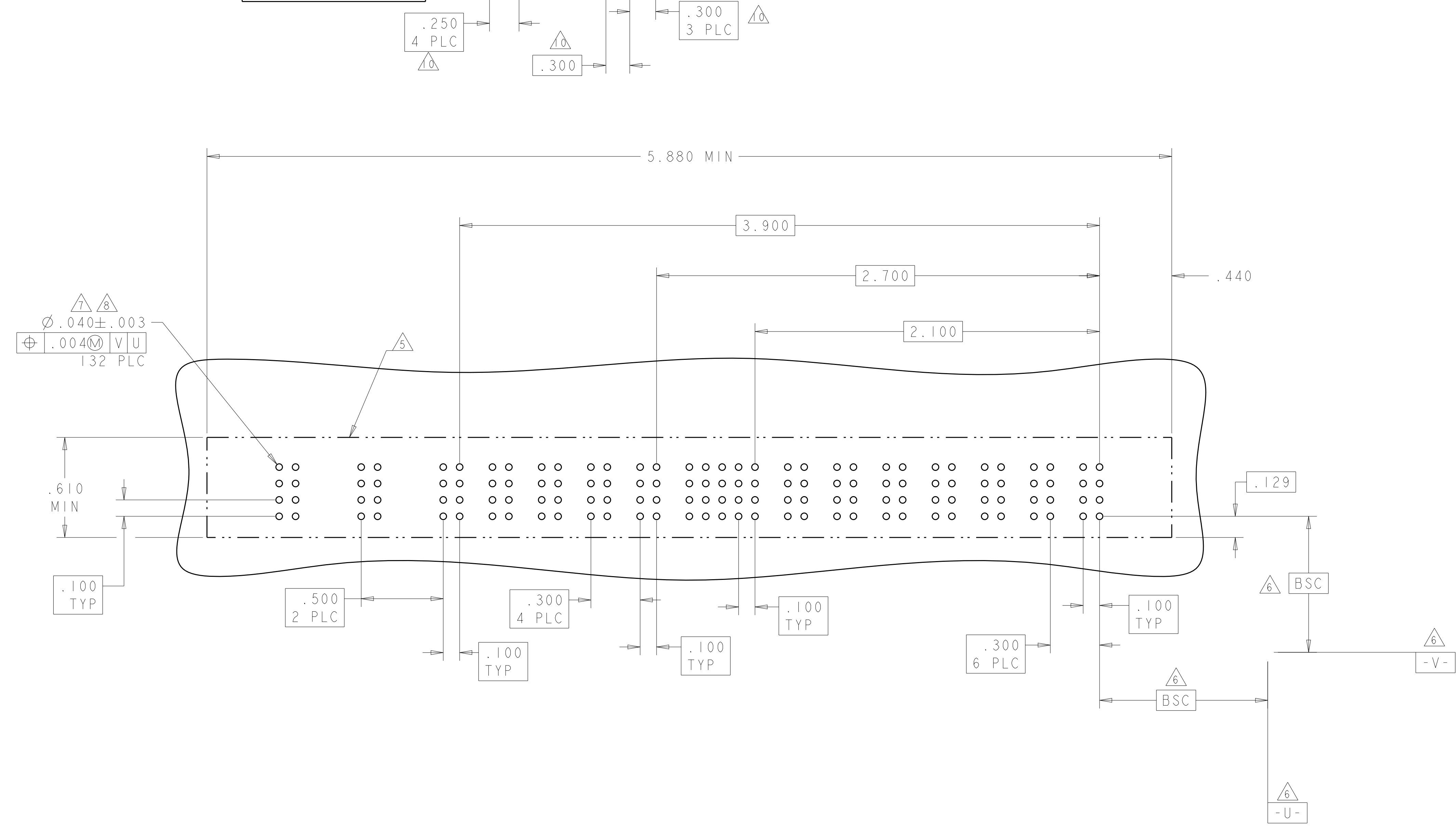

THIS DRAWING IS A CONTROLLED DOCUMENT.		DWN: R. GRZYBOWSKI 16FEB05	TE Connectivity
DIMENSIONS: INCHES		CHK: M. PERCHERKE 16FEB05	
TOLERANCES UNLESS OTHERWISE SPECIFIED:		APVD: M. PERCHERKE	NAME: VERTICAL RECEPTACLE ASSEMBLY WITH GUIDES MULTI-BEAM XL
0 PLC ±. 1 PLC ±.01 2 PLC ±.01 3 PLC ±.005 4 PLC ±.0020 ANGLES ±.2°		PRODUCT SPEC: 108-1973	SIZE: A1
MATERIAL: -		APPLICATION SPEC: 114-13038	CAGE CODE: 6450150
FINISH: -		WEIGHT: -	RESTRICTED TO: -
CUSTOMER DRAWING		SCALE: 1:1	SHEET 8 OF 12 REV G5

LOC		DIST		REVISIONS				
P	LTN	DATE	DMN	APVD	DESCRIPTION	DATE	DMN	APVD
-	-	-	-	-	SEE SHEET 1	-	-	-

PART NUMBER	ROWS	POWER		SIGNAL				POWER	
		P4	P3	4	3	2	1	P2	P1
2-6450150-3	D	VM	VM	E	E	E	E	VA	VA
	C			E	E	E	E		
	B			E	E	E	E		
	A			E	E	E	E		
2P + 16S + 2P		HD						HD	

PART NUMBER	ROWS	POWER		SIGNAL												POWER					
		P4	P3	12	11	10	9	8	7	6	5	4	3	2	1	P2	P1				
2-6450150-4	D	VM	VA	E	E	E	E	E	E	E	E	E	E	E	E	E	E	E	VA	VM	
	C			E	E	E	E	E	E	E	E	E	E	E	E	E	E	E			
	B			E	E	E	E	E	E	E	E	E	E	E	E	E	E	E			E
	A			E	E	E	E	E	E	E	E	E	E	E	E	E	E	E			E
2P + 48S + 2P		HD														HD					

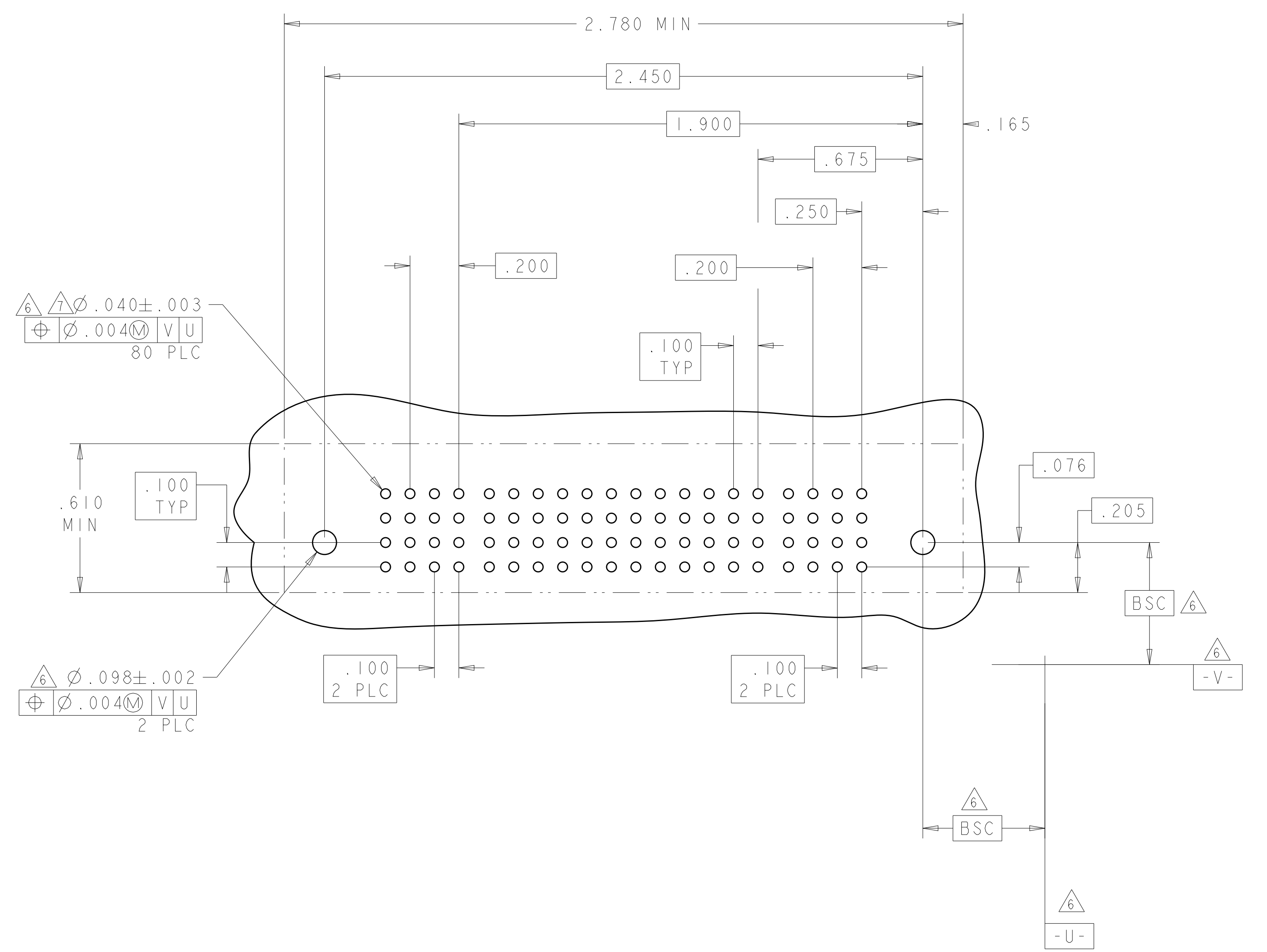
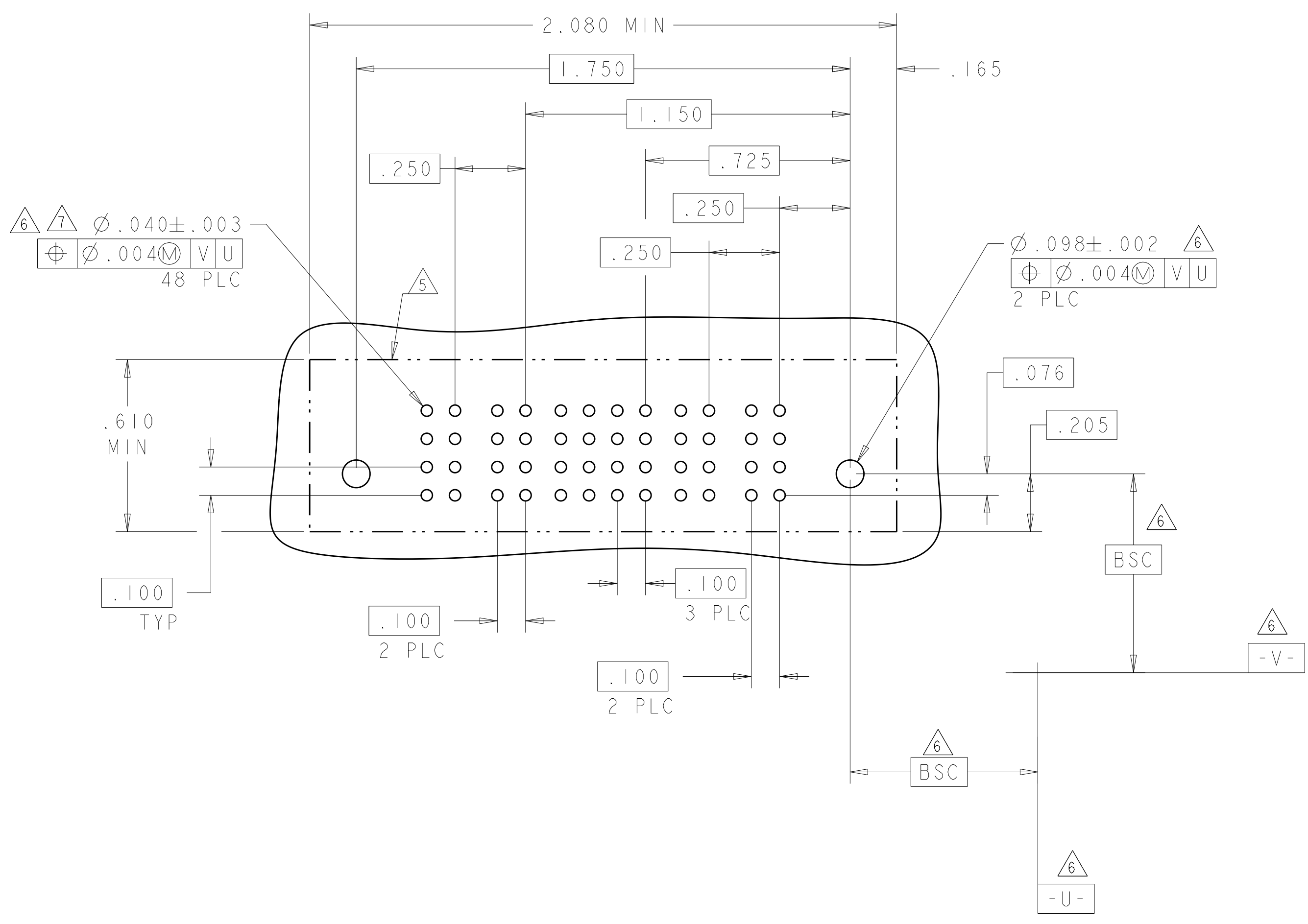

THIS DRAWING IS A CONTROLLED DOCUMENT. DWN: R. GRZYBOWSKI 16FEB05
 CHK: M. PERCHERKE 16FEB05
 APVD: M. PERCHERKE

DIMENSIONS: INCHES. TOLERANCES UNLESS OTHERWISE SPECIFIED:
 0 PLC ±.01
 1 PLC ±.01
 2 PLC ±.01
 3 PLC ±.01
 4 PLC ±.005
 ANGLES ±.0020

MATERIAL: FINISH:

PRODUCT SPEC: 108-1973
 APPLICATION SPEC: 114-13038
 WEIGHT: CUSTOMER DRAWING

NAME: VERTICAL RECEPTACLE ASSEMBLY WITH GUIDES MULTI-BEAM XL
 SIZE: A1
 CAGE CODE: 100779
 DRAWING NO: 6450150
 SCALE: 1:1
 SHEET 9 OF 12
 REV G5

STE TE Connectivity

LOC	DIST	REVISIONS			
P	LTN	DESCRIPTION	DATE	DWN	APVD
-	-	SEE SHEET 1	-	-	-

PART NUMBER	ROWS		POWER (L)					SIGNAL								POWER (R)										
			PI4	PI3	PI2	PI1	PI0	P9	8	7	6	5	4	3	2	1	P8	P7	P6	P5	P4		P3	P2	PI	
2-6450150-7	D C B A		VM	VM		VM	VM		E	E	E	E	E	E	E	E		VA		VM	VM		VM	VM		
8ACP + 32S + 6ACP																										

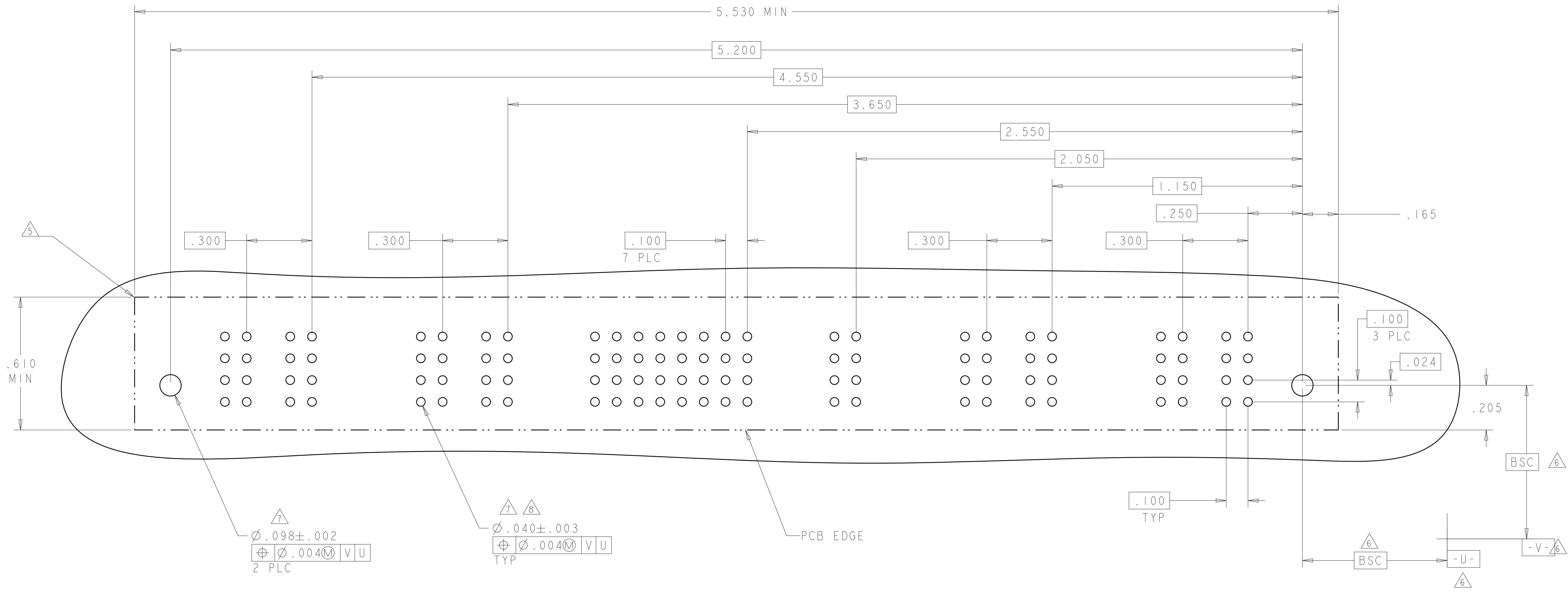

THIS DRAWING IS A CONTROLLED DOCUMENT.

DIMENSIONS: INCHES	TOLERANCES UNLESS OTHERWISE SPECIFIED: 0 PLC ±. 1 PLC ±.01 2 PLC ±.01 3 PLC ±.005 4 PLC ±.0020 ANGLES ±.0°	DWN: R. GRZYBOWSKI 16FEB05 CHK: M. PERCHERKE 16FEB05 APVD: M. PERCHERKE	NAME: VERTICAL RECEPTACLE ASSEMBLY WITH GUIDES MULTI-BEAM XL
MATERIAL: -	FINISH: -	PRODUCT SPEC: 108-1973 APPLICATION SPEC: 114-13038 WEIGHT: -	SIZE: A1 CAGE CODE: 6450150 DRAWING NO: 100779
CUSTOMER DRAWING		SCALE: 1:1	SHEET 11 OF 12 REV G5

4805 (3/11)

LOC	DIST	REVISIONS					
		P	LTN	DESCRIPTION	DATE	DMN	APVD
ES	00	-	-	SEE SHEET 1	-	-	-

PART NUMBER	ROWS	POWER						SIGNAL							
		P8	P7	P6	P5	P4	P3	4	3	2	3	2	1	P2	P1
2-6450150-9	D							E	E	E	E	E			
	C							E	E	E	E	E	VM	VM	
	B							E	E	E	E	E			
	A	HD						E	E	E	E	E		HD	

NO CONTACTS LOADED (pointing to P8, P7, P6, P5, P4, P3)
 NO CONTACTS LOADED (pointing to P2, P1)

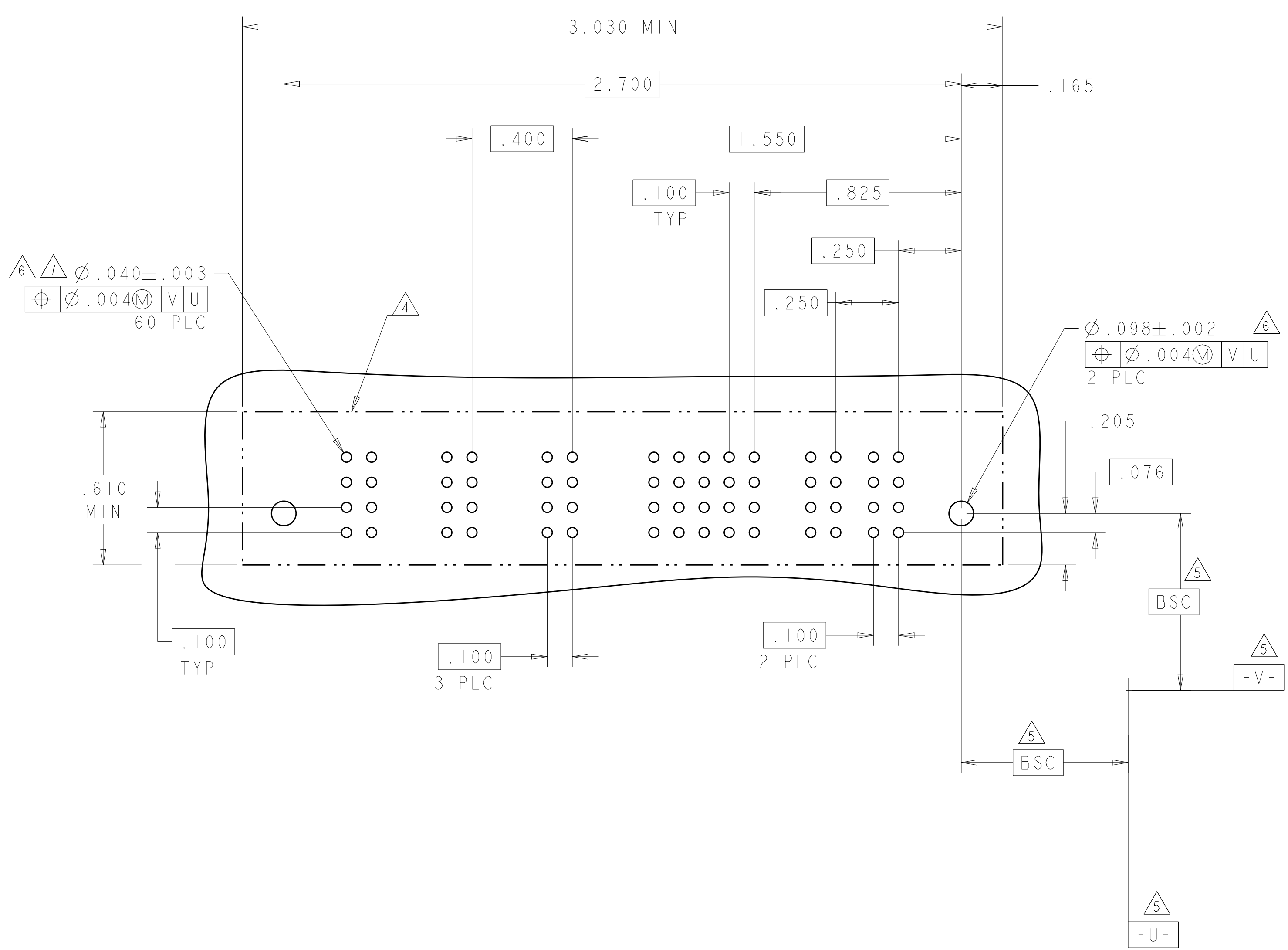

THIS DRAWING IS A CONTROLLED DOCUMENT.		DMN: R. GRZYBOWSKI 16FEB05	TE Connectivity
DIMENSIONS: INCHES		CHK: M. PERCHERKE 16FEB05	
TOLERANCES UNLESS OTHERWISE SPECIFIED: 0 PLC ±. 1 PLC ±.01 2 PLC ±.01 3 PLC ±.005 4 PLC ±.0020 ANGLES ±.2°		APVD: M. PERCHERKE	NAME: VERTICAL RECEPTACLE ASSEMBLY WITH GUIDES MULTI-BEAM XL
MATERIAL: -		FINISH: -	PRODUCT SPEC: 108-1973
SCALE: 1:1		WEIGHT: -	APPLICATION SPEC: 114-13038
SHEET 12 OF 12		RESTRICTED TO: -	SIZE: A1
CUSTOMER DRAWING		SCALE: 1:1	CAGE CODE: 6450150
REV: G5		DATE: -	REV: G5

Mouser Electronics

Authorized Distributor

Click to View Pricing, Inventory, Delivery & Lifecycle Information:

[TE Connectivity:](#)

[6450150-6](#)