

4

3

2

1

THIS DRAWING IS UNPUBLISHED. RELEASED FOR PUBLICATION 20

© COPYRIGHT 20 BY TYCO ELECTRONICS CORPORATION. ALL RIGHTS RESERVED.

LOC	DIST	REVISIONS					
		P	LTR	DESCRIPTION	DATE	DWN	APVD
AD	00		A	ECO-07-010931	14MAY2007	RB	DR
			B	ECO-07-018972	15AUG2007	RB	DR

⚠ MATERIAL: THERMOPLASTIC, COLOR: SEE TABLE

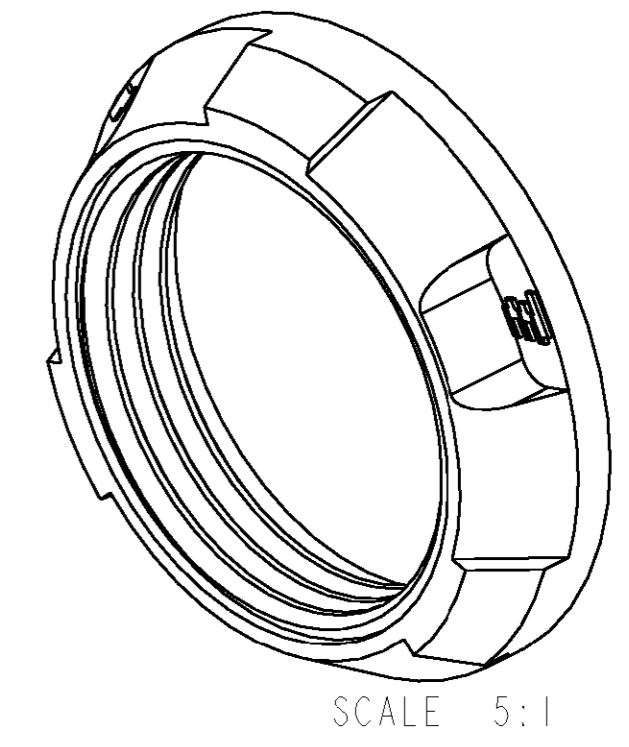
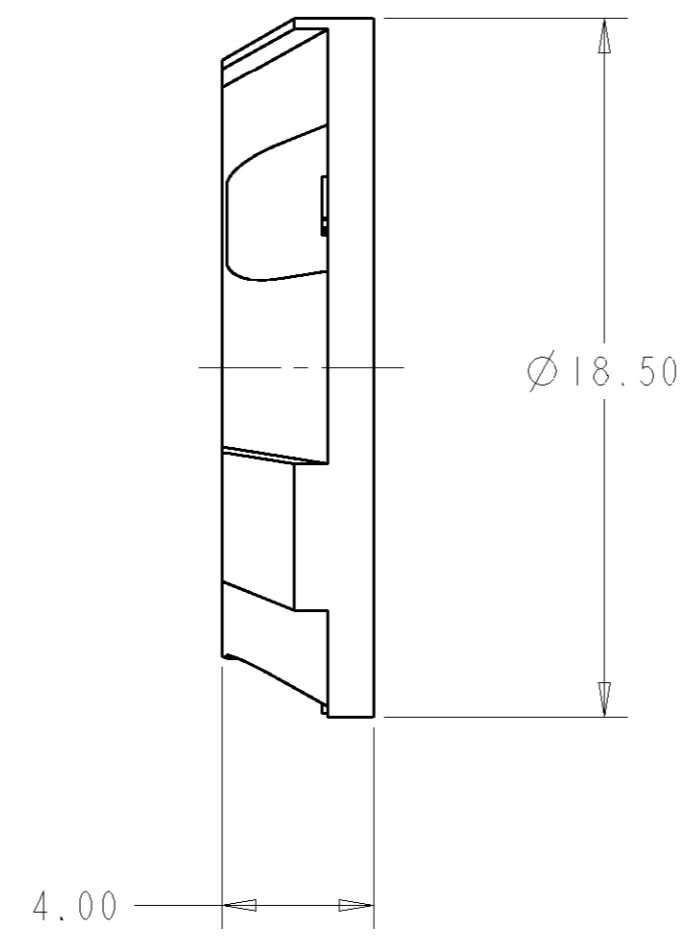
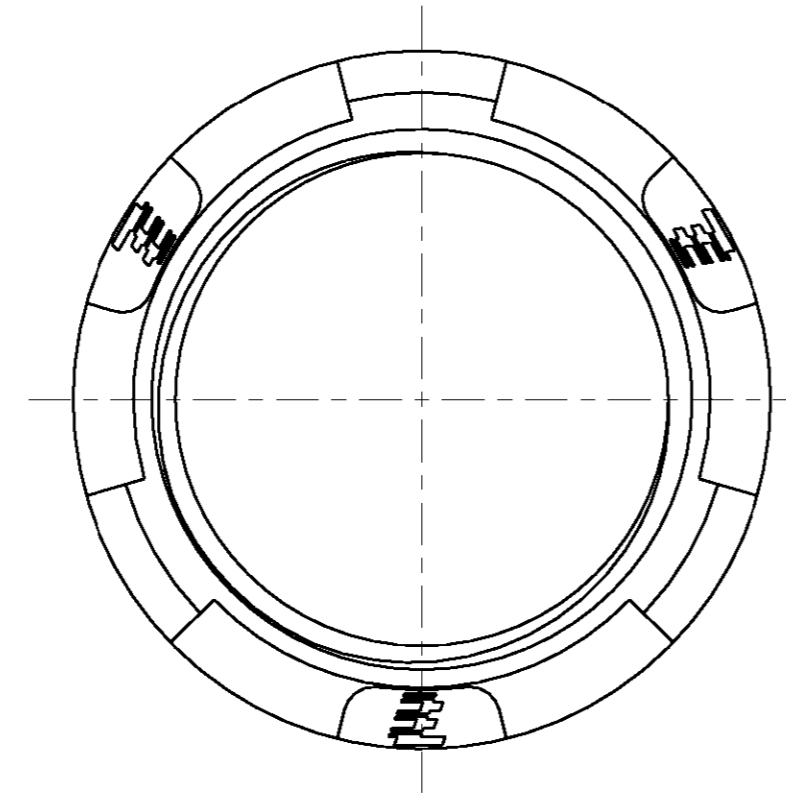

BLACK	1811448-7
GRAY	1811448-6
BLUE	1811448-5
GREEN	1811448-4
YELLOW	1811448-3
WHITE	1811448-2
RED	1811448-1
COLOR	PART NO.

<small>THIS DRAWING IS A CONTROLLED DOCUMENT FOR TYCO ELECTRONICS CORPORATION IT IS SUBJECT TO CHANGE AND THE CONTROLLING ENGINEERING ORGANIZATION SHOULD BE CONTACTED FOR THE LATEST REVISION.</small>		DWN <u>RLK</u> 07DEC2006 CHK <u>L. BREKOSKY</u> 14DEC2006 APVD - PRODUCT SPEC - APPLICATION SPEC - WEIGHT -	Tyco Electronics Tyco Electronics Harrisburg, PA 17105-3608
DIMENSIONS: mm 	TOLERANCES UNLESS OTHERWISE SPECIFIED: 0 PLC ± 1 PLC ±0.13 2 PLC ±0.08 3 PLC ± 4 PLC ± ANGLES ±° FINISH -	NAME NUT, ADJUSTABLE FRONT	SIZE CAGE CODE DRAWING NO RESTRICTED TO A2 00779 C-1811448 -
MATERIAL -		CUSTOMER DRAWING	SCALE 5:1 SHEET 1 OF 1 REV B

Mouser Electronics

Authorized Distributor

Click to View Pricing, Inventory, Delivery & Lifecycle Information:

[TE Connectivity:](#)

[1811448-2](#)