

Base strip - MSTBVK 2,5/11-G-5,08 - 1788813

Please be informed that the data shown in this PDF Document is generated from our Online Catalog. Please find the complete data in the user's documentation. Our General Terms of Use for Downloads are valid (<http://phoenixcontact.com/download>)



Plug component, Nominal current: 12 A, Rated voltage (III/2): 320 V, Number of positions: 11, Pitch: 5.08 mm, Connection method: Screw connection with tension sleeve, Color: green, Contact surface: Tin, Mounting: DIN rail

The figure shows a 10-position version of the product

Product Features

- Can be combined with COMBICON plugs with 5.08 mm pitch
- With foot element for mounting on 15 x 5 mm DIN rails (NS 15) according to EN 60715-TH15



Key Commercial Data

Packing unit	1 pc
GTIN	 4 017918 043872
Weight per Piece (excluding packing)	28.03 g
Custom tariff number	85366990
Country of origin	Germany

Technical data

Dimensions

Width	27.2 mm
Pitch	5.08 mm
Dimension a	50.8 mm

General

Range of articles	MSTBVK 2,5/...-G
Insulating material group	I
Rated surge voltage (III/3)	4 kV

Base strip - MSTBVK 2,5/11-G-5,08 - 1788813

Technical data

General

Rated surge voltage (III/2)	4 kV
Rated surge voltage (II/2)	4 kV
Rated voltage (III/3)	320 V
Rated voltage (III/2)	320 V
Rated voltage (II/2)	630 V
Connection in acc. with standard	EN-VDE
Nominal current I_N	12 A
Nominal cross section	2.5 mm ²
Maximum load current	12 A
Insulating material	PA
Flammability rating according to UL 94	V0
Internal cylindrical gage	A3
Stripping length	7 mm
Number of positions	11
Screw thread	M3
Tightening torque, min	0.5 Nm
Tightening torque max	0.6 Nm

Connection data

Conductor cross section solid min.	0.2 mm ²
Conductor cross section solid max.	2.5 mm ²
Conductor cross section flexible min.	0.2 mm ²
Conductor cross section flexible max.	2.5 mm ²
Conductor cross section flexible, with ferrule without plastic sleeve min.	0.25 mm ²
Conductor cross section flexible, with ferrule without plastic sleeve max.	2.5 mm ²
Conductor cross section flexible, with ferrule with plastic sleeve min.	0.25 mm ²
Conductor cross section flexible, with ferrule with plastic sleeve max.	2.5 mm ²
Conductor cross section AWG min.	24
Conductor cross section AWG max.	12
2 conductors with same cross section, solid min.	0.2 mm ²
2 conductors with same cross section, solid max.	1 mm ²
2 conductors with same cross section, stranded min.	0.2 mm ²
2 conductors with same cross section, stranded max.	1.5 mm ²
2 conductors with same cross section, stranded, ferrules without plastic sleeve, min.	0.25 mm ²
2 conductors with same cross section, stranded, ferrules without plastic sleeve, max.	1 mm ²
2 conductors with same cross section, stranded, TWIN ferrules with plastic sleeve, min.	0.5 mm ²

Base strip - MSTBVK 2,5/11-G-5,08 - 1788813

Technical data

Connection data

2 conductors with same cross section, stranded, TWIN ferrules with plastic sleeve, max.	1.5 mm ²
Minimum AWG according to UL/CUL	30
Maximum AWG according to UL/CUL	12

Standards and Regulations

Connection in acc. with standard	EN-VDE
	CSA
Flammability rating according to UL 94	V0

Classifications

eCl@ss

eCl@ss 4.0	272607xx
eCl@ss 4.1	27260701
eCl@ss 5.0	27260701
eCl@ss 5.1	27260701
eCl@ss 6.0	27260704
eCl@ss 7.0	27440402
eCl@ss 8.0	27141106
eCl@ss 9.0	27141106

ETIM

ETIM 3.0	EC001121
ETIM 4.0	EC002638
ETIM 5.0	EC001284

UNSPSC

UNSPSC 6.01	30211810
UNSPSC 7.0901	39121409
UNSPSC 11	39121409
UNSPSC 12.01	39121409
UNSPSC 13.2	39121409

Approvals

Approvals

Base strip - MSTBVK 2,5/11-G-5,08 - 1788813

Approvals

Approvals

CSA / UL Recognized / VDE Gutachten mit Fertigungsüberwachung / cUL Recognized / IEC60335 CB Scheme / EAC / EAC / cULus Recognized

Ex Approvals

Approvals submitted

Approval details

CSA		
	B	D
mm ² /AWG/kcmil	28-12	28-12
Nominal current I _N	10 A	10 A
Nominal voltage U _N	300 V	300 V

UL Recognized		
	B	D
mm ² /AWG/kcmil	30-12	30-12
Nominal current I _N	12 A	10 A
Nominal voltage U _N	250 V	300 V

VDE Gutachten mit Fertigungsüberwachung	
mm ² /AWG/kcmil	0.2-2.5
Nominal current I _N	12 A
Nominal voltage U _N	250 V

Base strip - MSTBVK 2,5/11-G-5,08 - 1788813

Approvals

cUL Recognized		
	B	D
mm ² /AWG/kcmil	30-12	30-12
Nominal current I _N	12 A	10 A
Nominal voltage U _N	250 V	300 V

IECEE CB Scheme	
mm ² /AWG/kcmil	0.2-2.5
Nominal current I _N	12 A
Nominal voltage U _N	250 V

EAC

EAC

cULus Recognized

Accessories

Accessories

Bridge

Insertion bridge - EBP 2- 5 - 1733169

Insertion bridge, fully insulated, for connectors with 5.0 or 5.08 mm pitch, no. of positions: 2



Coding element

Base strip - MSTBVK 2,5/11-G-5,08 - 1788813

Accessories

Coding star - CR-MSTB - 1734401



Coding section, inserted into the recess in the header or the inverted plug, red insulating material

Filler plug

Accessories - MSTB-BL - 1755477



Keying cap, for forming sections, plugs onto header pin, green insulating material

Labeled terminal marker

Marker card - SK 5,08/3,8:FORTL.ZAHLEN - 0804293



Marker card, Card, white, labeled, Horizontal: Consecutive numbers 1 - 10, 11 - 20, etc. up to 91 - (99)100, Mounting type: Adhesive, for terminal block width: 5.08 mm, Lettering field: 5.08 x 3.8 mm

Screwdriver tools

Screwdriver - SZS 0,6X3,5 - 1205053



Actuation tool, for ST terminal blocks, insulated, also suitable for use as a bladed screwdriver, size: 0.6 x 3.5 x 100 mm, 2-component grip, with non-slip grip

Additional products

Base strip - MSTBVK 2,5/11-G-5,08 - 1788813

Accessories

Printed-circuit board connector - MSTB 2,5/11-ST-5,08 - 1757103



Plug component, Nominal current: 12 A, Rated voltage (III/2): 320 V, Number of positions: 11, Pitch: 5.08 mm, Connection method: Screw connection with tension sleeve, Color: green, Contact surface: Tin

Printed-circuit board connector - MSTB 2,5/11-STZ-5,08 - 1764293



Plug component, Nominal current: 12 A, Rated voltage (III/2): 320 V, Number of positions: 11, Pitch: 5.08 mm, Connection method: Screw connection with tension sleeve, Color: green, Contact surface: Tin

Printed-circuit board connector - MSTBP 2,5/11-ST-5,08 - 1769104



Plug component, Nominal current: 12 A, Rated voltage (III/2): 320 V, Number of positions: 11, Pitch: 5.08 mm, Connection method: Screw connection with tension sleeve, Color: green, Contact surface: Tin

Printed-circuit board connector - SMSTB 2,5/11-ST-5,08 - 1826377



Plug component, Nominal current: 12 A, Rated voltage (III/2): 320 V, Number of positions: 11, Pitch: 5.08 mm, Connection method: Screw connection with tension sleeve, Color: green, Contact surface: Tin

Printed-circuit board connector - MVSTBR 2,5/11-ST-5,08 - 1792333



Plug component, Nominal current: 12 A, Rated voltage (III/2): 320 V, Number of positions: 11, Pitch: 5.08 mm, Connection method: Screw connection with tension sleeve, Color: green, Contact surface: Tin

Base strip - MSTBVK 2,5/11-G-5,08 - 1788813

Accessories

Printed-circuit board connector - MVSTBW 2,5/11-ST-5,08 - 1792841



Plug component, Nominal current: 12 A, Rated voltage (III/2): 320 V, Number of positions: 11, Pitch: 5.08 mm, Connection method: Screw connection with tension sleeve, Color: green, Contact surface: Tin

Printed-circuit board connector - FRONT-MSTB 2,5/11-ST-5,08 - 1777374



Plug component, Nominal current: 12 A, Rated voltage (III/2): 320 V, Number of positions: 11, Pitch: 5.08 mm, Connection method: Front screw connection, Color: green, Contact surface: Tin

Printed-circuit board connector - FKC 2,5/11-ST-5,08 - 1873142



Plug component, Nominal current: 12 A, Rated voltage (III/2): 320 V, Number of positions: 11, Pitch: 5.08 mm, Connection method: Push-in spring connection, Color: green, Contact surface: Tin

Printed-circuit board connector - FKCVR 2,5/11-ST-5,08 - 1874044



Plug component, Nominal current: 12 A, Rated voltage (III/2): 320 V, Number of positions: 11, Pitch: 5.08 mm, Connection method: Push-in spring connection, Color: green, Contact surface: Tin

Printed-circuit board connector - QC 1/11-ST-5,08 - 1883349

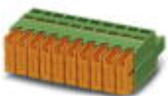

Plug component, Nominal current: 10 A, Rated voltage (III/2): 630 V, Number of positions: 11, Pitch: 5.08 mm, Connection method: Displacement connection, Color: green, Contact surface: Tin

Base strip - MSTBVK 2,5/11-G-5,08 - 1788813

Accessories

Printed-circuit board connector - MSTBC 2,5/11-ST-5,08 - 1808900

Plug component, Nominal current: 12 A, Rated voltage (III/2): 320 V, Number of positions: 11, Pitch: 5.08 mm, Connection method: Crimp connection, Color: green, Corresponding female crimp contacts with current [A] and conductor cross section range [mm²] data: 10A/MSTBC-MT 0,5-1,0 (3190564); 10A/MSTBC-MT 0,5-1,0 BA (3190645); 12A/MSTBC-MT 1,5-2,5 (3190551); 12A/MSTBC-MT 1,5-2,5 BA (3190658). BA = Bandkontakte



Printed-circuit board connector - MSTBC 2,5/11-STZ-5,08 - 1809598

Plug component, Nominal current: 12 A, Rated voltage (III/2): 320 V, Number of positions: 11, Pitch: 5.08 mm, Connection method: Crimp connection, Color: green, Corresponding female crimp contacts with current [A] and conductor cross section range [mm²] data: 10A/MSTBC-MT 0,5-1,0 (3190564); 10A/MSTBC-MT 0,5-1,0 BA (3190645); 12A/MSTBC-MT 1,5-2,5 (3190551); 12A/MSTBC-MT 1,5-2,5 BA (3190658). BA = Bandkontakte



Drawings

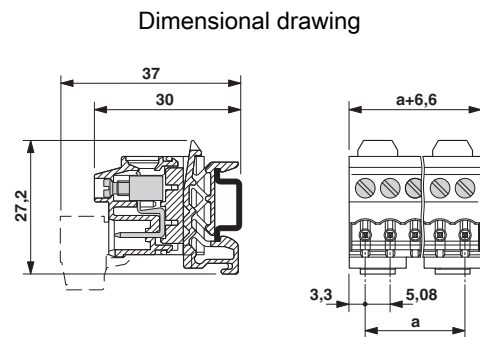
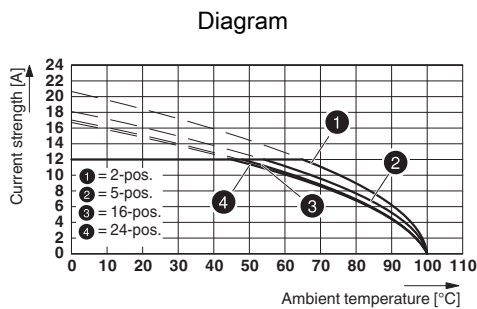

Type: MVSTBR 2,5/...-ST-5,08 with MSTBVK 2,5/...-G-5,08

Mouser Electronics

Authorized Distributor

Click to View Pricing, Inventory, Delivery & Lifecycle Information:

[Phoenix Contact:](#)

[1788813](#)