

FEATURES

- Input voltage range: 2.5 V to 5.5 V
- Small, 8-lead, 2 mm × 2 mm LFCSP package
- Initial accuracy: ±1%
- High PSRR: 70 dB at 10 kHz, 60 dB at 100 kHz, 40 dB at 1 MHz
- Low noise: 27 μ V rms at $V_{OUT} = 1.2$ V, 50 μ V rms at $V_{OUT} = 2.8$ V
- Excellent transient response
- Low dropout voltage: 170 mV at 300 mA load
- 65 μ A typical ground current at no load, both LDOs enabled
- Fixed output voltage from 0.8 V to 3.3 V (ADP222/ADP224)
- Adjustable output voltage range from 0.5 V to 5.0 V (ADP223/ADP225)
- Quick output discharge (QOD)—ADP224/ADP225
- Overcurrent and thermal protection

APPLICATIONS

- Portable and battery-powered equipment
- Portable medical devices
- Post dc-to-dc regulation
- Point of sale terminals
- Credit card readers
- Automatic meter readers
- Wireless network equipment

GENERAL DESCRIPTION

The 300 mA, adjustable dual output ADP223/ADP225 and fixed dual output ADP222/ADP224 combine high PSRR, low noise, low quiescent current, and low dropout voltage in a voltage regulator that is ideally suited for wireless applications with demanding performance and board space requirements.

The ADP222/ADP224 are available with fixed outputs voltages from 0.8V to 3.3V. The adjustable output ADP223/ADP225 may be set to output voltages from 0.5 V to 5.0 V. The low quiescent current, low dropout voltage, and wide input voltage range of the ADP222/ADP223/ADP224/ADP225 extend the battery life of portable devices.

The ADP222/ADP223/ADP224/ADP225 maintain power supply rejection greater than 60 dB for frequencies as high as

TYPICAL APPLICATION CIRCUITS

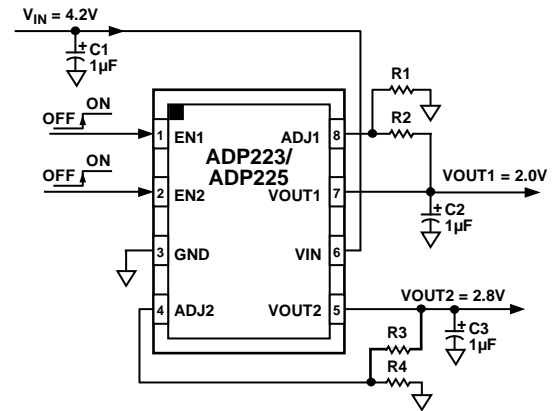

Figure 1. ADP223/ADP225

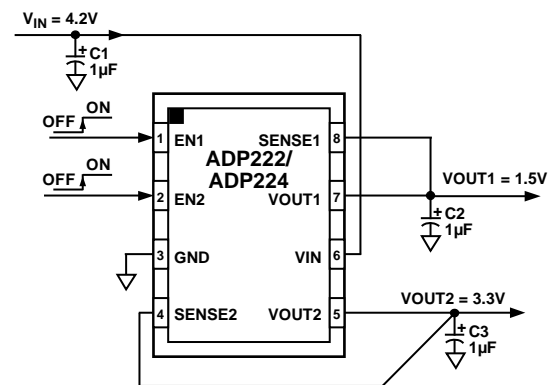

Figure 2. ADP222/ADP224

100 kHz while operating with a low headroom voltage. The ADP222/ADP223/ADP224/ADP225 offer much lower noise performance than competing LDOs without the need for a noise bypass capacitor. Overcurrent and thermal protection circuitry prevent damage in adverse conditions.

The ADP224 and ADP225 are identical to the ADP222 and ADP223, respectively, but with the addition of a quick output discharge (QOD) feature.

The ADP222/ADP223/ADP224/ADP225 are available in a small 8-lead, 2 mm × 2 mm LFCSP package and are stable with tiny 1 μ F, ±30% ceramic output capacitors, resulting in the smallest possible board area for a wide variety of portable power needs.

TABLE OF CONTENTS

Features	1
Applications.....	1
Typical Application Circuits.....	1
General Description	1
Revision History	2
Specifications.....	3
Input and Output Capacitor, Recommended Specifications..	4
Absolute Maximum Ratings.....	5
Thermal Data	5
Thermal Resistance	5
ESD Caution.....	5
Pin Configuration and Function Descriptions.....	6

REVISION HISTORY

5/14—Rev. D to Rev. E

Changes to Figure 1.....	1
Changes to Figure 64, V_{OUT1} Equation and Following Text	17
Deleted Paralleling Outputs to Increase Output Current Section and Figure 70.....	19
Updated Outline Dimensions	23

1/13—Rev. C to Rev. D

Changes to Table 5.....	6
Changes to Current Limit and Thermal Overload Protection Section.....	20

8/12—Rev. B to Rev. C

Changes to Ordering Guide	23
---------------------------------	----

8/11—Rev. A to Rev. B

Changes to Features and General Descriptions Sections	1
Added Figure 64; Renumbered Sequentially	17
Changes to Theory of Operation Section.....	17
Changes to Output Capacitor Section	18
Changes to Paralleling Outputs to Increase Output Current Section.....	19
Updated Outline Dimensions	23

Typical Performance Characteristics	7
Theory of Operation	17
Applications Information	18
Capacitor Selection	18
Enable Feature	19
Quick Output Discharge (QOD) Function	19
Current Limit and Thermal Overload Protection	20
Thermal Considerations.....	20
Printed Circuit Board Layout Considerations	22
Outline Dimensions	23
Ordering Guide	24

7/11—Rev. 0 to Rev. A

Added ADP222, ADP224, and ADP225	Universal
Changes to Features Section, Applications Section, General Description Section, and Figure 2.....	1
Changes to Table 1.....	3
Added Figure 4; Renumbered Sequentially	6
Changes to Table 5.....	6
Changes to Typical Performance Characteristics Section	7
Changes to Theory of Operation Section and Figure 62	17
Added Figure 63	17
Added Quick Output Discharge (QOD) Function Section	
Added Figure 70	20

2/11—Revision 0: Initial Version

SPECIFICATIONS

$V_{IN} = (V_{OUT} + 0.5 \text{ V})$ or 2.5 V (whichever is greater), $EN1 = EN2 = V_{IN}$, $I_{OUT1} = I_{OUT2} = 10 \text{ mA}$, $C_{IN} = C_{OUT1} = C_{OUT2} = 1 \mu\text{F}$, $T_A = 25^\circ\text{C}$, unless otherwise noted.

Table 1.

Parameter	Symbol	Test Conditions/Comments	Min	Typ	Max	Unit				
INPUT VOLTAGE RANGE	V_{IN}	$T_J = -40^\circ\text{C}$ to $+125^\circ\text{C}$	2.5		5.5	V				
OPERATING SUPPLY CURRENT WITH BOTH REGULATORS ON	I_{GND}	$I_{OUT} = 0 \mu\text{A}$		65		μA				
		$I_{OUT} = 0 \mu\text{A}$, $T_J = -40^\circ\text{C}$ to $+125^\circ\text{C}$			150	μA				
		$I_{OUT} = 10 \text{ mA}$		100		μA				
		$I_{OUT} = 10 \text{ mA}$, $T_J = -40^\circ\text{C}$ to $+125^\circ\text{C}$			200	μA				
		$I_{OUT} = 300 \text{ mA}$		300		μA				
		$I_{OUT} = 300 \text{ mA}$, $T_J = -40^\circ\text{C}$ to $+125^\circ\text{C}$			450	μA				
SHUTDOWN CURRENT	I_{GND-SD}	$EN1 = EN2 = \text{GND}$		0.2	2	μA				
OUTPUT VOLTAGE ACCURACY ¹	V_{OUT}	$T_J = -40^\circ\text{C}$ to $+125^\circ\text{C}$								
		$I_{OUT} = 10 \text{ mA}$	-1		+1	%				
		$0 \mu\text{A} < I_{OUT} < 300 \text{ mA}$, $V_{IN} = (V_{OUT} + 0.5 \text{ V})$ to 5.5 V	-2		+2	%				
ADJUSTABLE-OUTPUT VOLTAGE ACCURACY ¹	V_{ADJ}	$T_J = -40^\circ\text{C}$ to $+125^\circ\text{C}$								
		$I_{OUT} = 10 \text{ mA}$	0.495	0.500	0.505	V				
		$0 \mu\text{A} < I_{OUT} < 300 \text{ mA}$, $V_{IN} = (V_{OUT} + 0.5 \text{ V})$ to 5.5 V	0.490		0.510	V				
LINE REGULATION	$\Delta V_{OUT}/\Delta V_{IN}$	$V_{IN} = (V_{OUT} + 0.5 \text{ V})$ to 5.5 V		0.01		%/V				
		$V_{IN} = (V_{OUT} + 0.5 \text{ V})$ to 5.5 V, $T_J = -40^\circ\text{C}$ to $+125^\circ\text{C}$	-0.05		+0.05	%/V				
LOAD REGULATION ²	$\Delta V_{OUT}/\Delta I_{OUT}$	$I_{OUT} = 1 \text{ mA}$ to 300 mA		0.001		%/mA				
		$I_{OUT} = 1 \text{ mA}$ to 300 mA, $T_J = -40^\circ\text{C}$ to $+125^\circ\text{C}$			0.002	%/mA				
DROPOUT VOLTAGE ³	$V_{DROPOUT}$	$V_{OUT} = 3.3 \text{ V}$		6		mV				
		$I_{OUT} = 10 \text{ mA}$			9	mV				
		$I_{OUT} = 10 \text{ mA}$, $T_J = -40^\circ\text{C}$ to $+125^\circ\text{C}$								
		$I_{OUT} = 300 \text{ mA}$		170		mV				
		$I_{OUT} = 300 \text{ mA}$, $T_J = -40^\circ\text{C}$ to $+125^\circ\text{C}$			260	mV				
SENSE INPUT BIAS CURRENT	$SENSE_{I-BIAS}$	$2.5 \text{ V} \leq V_{IN} \leq 5.5 \text{ V}$, $SENSE_{EX}$ connected to V_{OUTx}		10		nA				
ADJx INPUT BIAS CURRENT	ADJ_{I-BIAS}	$2.5 \text{ V} \leq V_{IN} \leq 5.5 \text{ V}$, ADJ_{EX} connected to V_{OUTx}		10		nA				
START-UP TIME ⁴	$t_{START-UP}$	$V_{OUT} = 3.3 \text{ V}$		240		μs				
		$V_{OUT} = 0.8 \text{ V}$		100		μs				
CURRENT-LIMIT THRESHOLD ⁵	I_{LIMIT}		340	400		mA				
THERMAL SHUTDOWN		T_J rising		155		$^\circ\text{C}$				
				15		$^\circ\text{C}$				
EN INPUT				1.2	0.4	V				
							EN Input Logic High			
							EN Input Logic Low			
EN Input Leakage Current	$V_{I-LEAKAGE}$	$EN1 = EN2 = V_{IN}$ or GND		0.1		μA				
		$EN1 = EN2 = V_{IN}$ or GND, $T_J = -40^\circ\text{C}$ to $+125^\circ\text{C}$			1	μA				
UNDERVOLTAGE LOCKOUT			2.2	120	2.45	V				
							Input Voltage Rising			
							Input Voltage Falling			
							Hysteresis			
OUTPUT DISCHARGE TIME	t_{DIS}	$V_{OUT} = 2.8 \text{ V}$		1000		μs				
OUTPUT DISCHARGE RESISTANCE	R_{QOD}			140		Ω				

Parameter	Symbol	Test Conditions/Comments	Min	Typ	Max	Unit	
OUTPUT NOISE	OUT _{NOISE}	10 Hz to 100 kHz, V _{IN} = 5 V, V _{OUT} = 3.3 V		56		μV rms	
		10 Hz to 100 kHz, V _{IN} = 5 V, V _{OUT} = 2.8 V		50		μV rms	
		10 Hz to 100 kHz, V _{IN} = 3.6 V, V _{OUT} = 2.5 V		45		μV rms	
		10 Hz to 100 kHz, V _{IN} = 3.6 V, V _{OUT} = 1.2 V		27		μV rms	
POWER SUPPLY REJECTION RATIO	PSRR	V _{IN} = 2.5 V, V _{OUT} = 0.8 V, I _{OUT} = 100 mA					
		100 Hz		76		dB	
		1 kHz		76		dB	
		10 kHz		70		dB	
		100 kHz		60		dB	
		1 MHz		40		dB	
		V _{IN} = 3.8 V, V _{OUT} = 2.8 V, I _{OUT} = 100 mA					
		100 Hz		68		dB	
		1 kHz		68		dB	
		10 kHz		68		dB	
100 kHz		60		dB			
1 MHz		40		dB			

¹ Accuracy when V_{OUTx} is connected directly to ADJ_x or SENSE_x. When the V_{OUTx} voltage is set by external feedback resistors, the absolute accuracy in adjust mode depends on the tolerances of resistors used.

² Based on an end-point calculation using 1 mA and 300 mA loads.

³ Dropout voltage is defined as the input-to-output voltage differential when the input voltage is set to the nominal output voltage. This applies only for output voltages above 2.5 V.

⁴ Start-up time is defined as the time between the rising edge of EN to V_{OUT} being at 90% of its nominal value.

⁵ Current-limit threshold is defined as the current at which the output voltage drops to 90% of the specified typical value. For example, the current limit for a 3.0 V output voltage is defined as the current that causes the output voltage to drop to 90% of 3.0 V or 2.7 V.

INPUT AND OUTPUT CAPACITOR, RECOMMENDED SPECIFICATIONS

The minimum input and output capacitance should be greater than 0.70 μF over the full range of the operating conditions. The full range of the operating conditions in the application must be considered during device selection to ensure that the minimum capacitance specification is met. X7R and X5R type capacitors are recommended for use with the LDOs, but Y5V and Z5U capacitors are not recommended for use with the LDOs.

Table 2.

Parameter	Symbol	Conditions	Min	Typ	Max	Unit
MINIMUM INPUT AND OUTPUT CAPACITANCE	C _{MIN}	T _A = -40°C to +125°C	0.70			μF
CAPACITOR ESR	R _{ESR}	T _A = -40°C to +125°C	0.001		1	Ω

ABSOLUTE MAXIMUM RATINGS

Table 3.

Parameter	Rating
VIN to GND	−0.3 V to +6 V
ADJ1, ADJ2, VOUT1, VOUT2 to GND	−0.3 V to VIN
EN1, EN2 to GND	−0.3 V to +6 V
Storage Temperature Range	−65°C to +150°C
Operating Junction Temperature Range	−40°C to +125°C
Soldering Conditions	JEDEC J-STD-020

Stresses above those listed under Absolute Maximum Ratings may cause permanent damage to the device. This is a stress rating only; functional operation of the device at these or any other conditions above those indicated in the operational section of this specification is not implied. Exposure to absolute maximum rating conditions for extended periods may affect device reliability.

THERMAL DATA

Absolute maximum ratings apply individually only, not in combination.

The [ADP222/ADP223/ADP224/ADP225](#) can be damaged when the junction temperature limits are exceeded. Monitoring ambient temperature does not guarantee that T_J is within the specified temperature limits. In applications with high power dissipation and poor thermal resistance, the maximum ambient temperature may have to be derated. In applications with moderate power dissipation and low PCB thermal resistance, the maximum ambient temperature can exceed the maximum limit as long as the junction temperature is within specification limits. The junction temperature (T_J) of the device is dependent on the ambient temperature (T_A), the power dissipation of the device (P_D), and the junction-to-ambient thermal resistance of the package (θ_{JA}). Maximum junction temperature (T_J) is calculated from the ambient temperature (T_A) and power dissipation (P_D) using the formula

$$T_J = T_A + (P_D \times \theta_{JA})$$

Junction-to-ambient thermal resistance (θ_{JA}) of the package is based on modeling and calculation using a 4-layer board. θ_{JA} is highly dependent on the application and board layout. In applications where high maximum power dissipation exists, close attention to thermal board design is required. The value of θ_{JA} may vary, depending on PCB material, layout, and environmental conditions. The specified value of θ_{JA} is based on a 4-layer, 4 in × 3 in, 2½ oz copper board, as per JEDEC standards. For more information, see the [AN-772](#) Application Note, *A Design and Manufacturing Guide for the Lead Frame Chip Scale Package (LFCSP)*.

Ψ_{JB} is the junction-to-board thermal characterization parameter with units of °C/W. Ψ_{JB} of the package is based on modeling and calculation using a 4-layer board. The JESD51-12, *Guidelines for Reporting and Using Package Thermal Information*, states that thermal characterization parameters are not the same as thermal resistances. Ψ_{JB} measures the component power flowing through multiple thermal paths rather than a single path as in thermal resistance, θ_{JB} . Therefore, Ψ_{JB} thermal paths include convection from the top of the package as well as radiation from the package, factors that make Ψ_{JB} more useful in real-world applications. Maximum junction temperature (T_J) is calculated from the board temperature (T_B) and power dissipation (P_D) using the formula

$$T_J = T_B + (P_D \times \Psi_{JB})$$

Refer to JESD51-8 and JESD51-12 for more detailed information about Ψ_{JB} .

THERMAL RESISTANCE

θ_{JA} and Ψ_{JB} are specified for the worst-case conditions, that is, a device soldered in a circuit board for surface-mount packages.

Table 4. Thermal Resistance

Package Type	θ_{JA}	θ_{JC}	Ψ_{JB}	Unit
8-Lead 2 mm × 2 mm LFCSP	50.2	31.7	18.2	°C/W

ESD CAUTION



ESD (electrostatic discharge) sensitive device. Charged devices and circuit boards can discharge without detection. Although this product features patented or proprietary protection circuitry, damage may occur on devices subjected to high energy ESD. Therefore, proper ESD precautions should be taken to avoid performance degradation or loss of functionality.

PIN CONFIGURATION AND FUNCTION DESCRIPTIONS

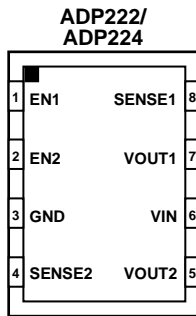

NOTES
1. CONNECT EXPOSED PAD TO GND.

Figure 3. ADP222/ADP224 Pin Configuration

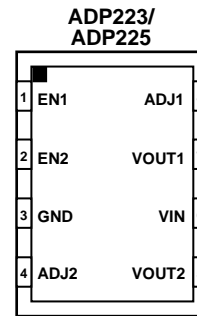

NOTES
1. CONNECT EXPOSED PAD TO GND.

Figure 4. ADP223/ADP225 Pin Configuration

Table 5. Pin Function Descriptions

Pin No.		Mnemonic	Description
ADP222/ADP224	ADP223/ADP225		
1	1	EN1	Enable Input for the First Regulator. Drive EN1 high to turn on Regulator 1 and drive EN1 low to turn off Regulator 1. For automatic startup, connect EN1 to VIN.
2	2	EN2	Enable Input for the Second Regulator. Drive EN2 high to turn on Regulator 2 and drive EN2 low to turn off Regulator 2. For automatic startup, connect EN2 to VIN.
3	3	GND	Ground Pin.
N/A ¹	4	ADJ2	Adjust Pin for VOUT2. A resistor divider from VOUT2 to ADJ2 sets the output voltage.
4	N/A ¹	SENSE2	Sense Pin for VOUT2.
5	5	VOUT2	Regulated Output Voltage. Connect an 1 μ F or greater output capacitor between VOUT2 and GND.
6	6	VIN	Regulator Input Supply. Bypass VIN to GND with a 1 μ F or greater capacitor.
7	7	VOUT1	Regulated Output Voltage. Connect 1 μ F or greater output capacitor between VOUT1 and GND.
N/A ¹	8	ADJ1	Adjust Pin for VOUT1. A resistor divider from VOUT1 to ADJ1 sets the output voltage.
8	N/A ¹	SENSE1 EPAD	Sense Pin for VOUT1. The exposed paddle must be connected to ground.

¹ N/A means not applicable.

TYPICAL PERFORMANCE CHARACTERISTICS

$V_{IN} = 5\text{ V}$, $V_{OUT1} = 3.3\text{ V}$, $V_{OUT2} = 2.8\text{ V}$, $I_{OUT1} = I_{OUT2} = 1\text{ mA}$, $C_{IN} = C_{OUT} = 1\text{ }\mu\text{F}$, $T_A = 25^\circ\text{C}$, unless otherwise noted.

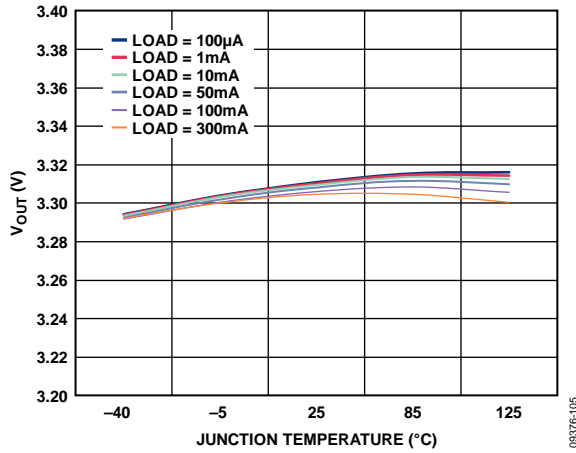

Figure 5. Output Voltage vs. Junction Temperature, $V_{OUTx} = 3.3\text{ V}$, ADP222/ADP224

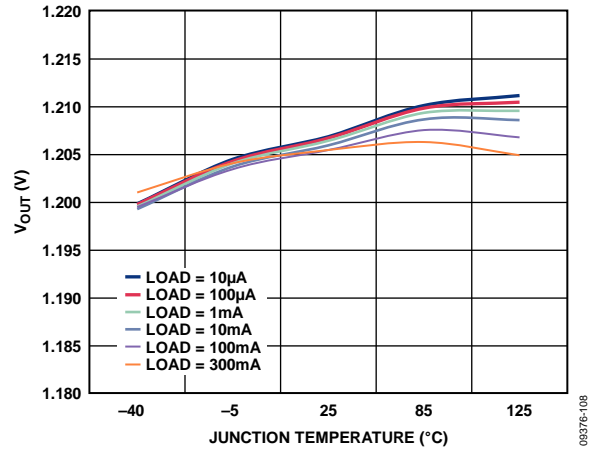

Figure 8. Output Voltage vs. Junction Temperature, $V_{OUTx} = 1.2\text{ V}$, ADP222/ADP224

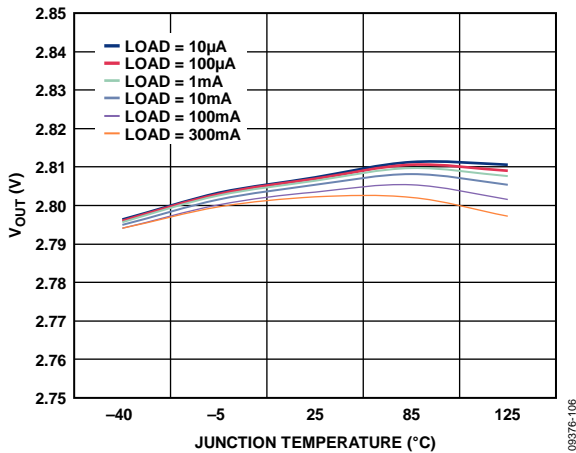

Figure 6. Output Voltage vs. Junction Temperature, $V_{OUTx} = 2.8\text{ V}$, ADP222/ADP224

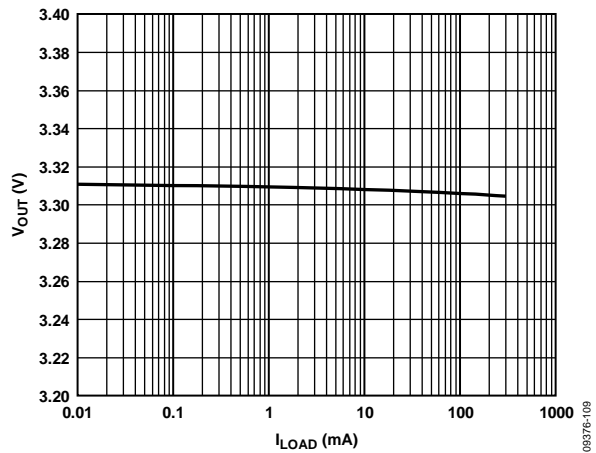

Figure 9. Output Voltage vs. Load Current, $V_{OUTx} = 3.3\text{ V}$, ADP222/ADP224

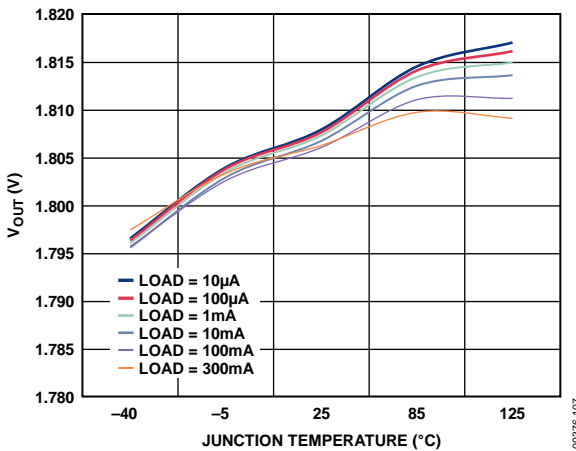

Figure 7. Output Voltage vs. Junction Temperature, $V_{OUTx} = 1.8\text{ V}$, ADP222/ADP224

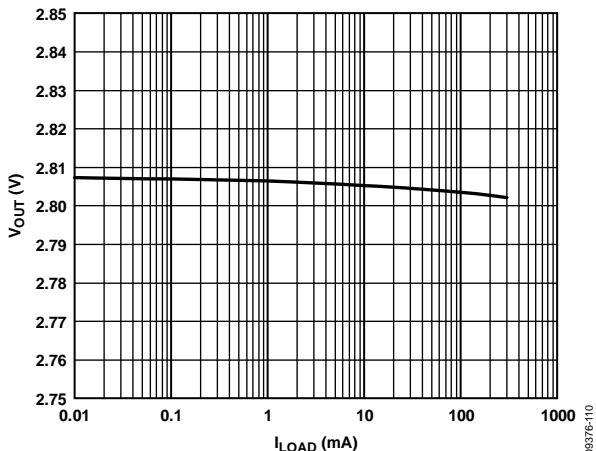

Figure 10. Output Voltage vs. Load Current, $V_{OUTx} = 2.8\text{ V}$, ADP222/ADP224

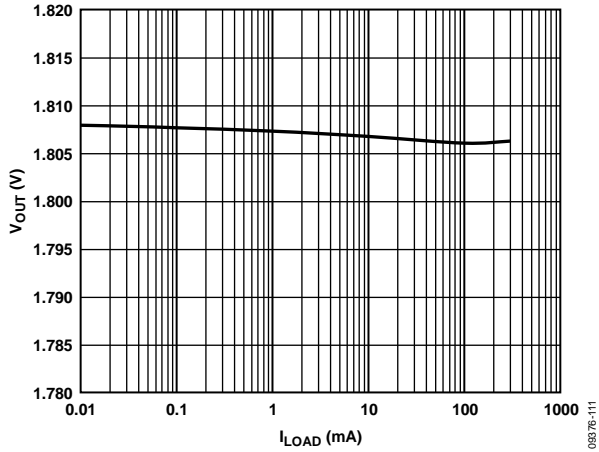

Figure 11. Output Voltage vs. Load Current, $V_{OUTx} = 1.8\text{ V}$, ADP222/ADP224

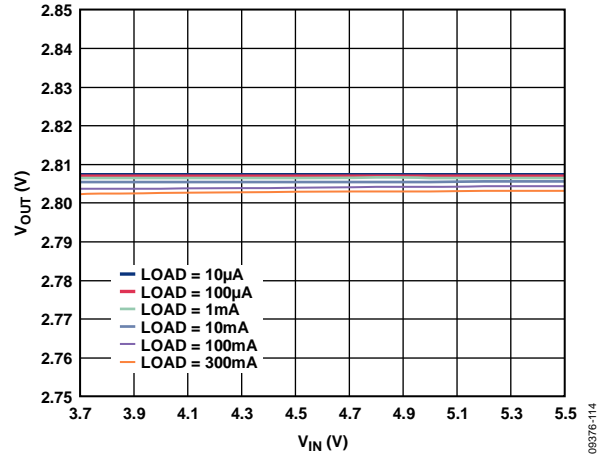

Figure 14. Output Voltage vs. Input Voltage, $V_{OUTx} = 2.8\text{ V}$, ADP222/ADP224

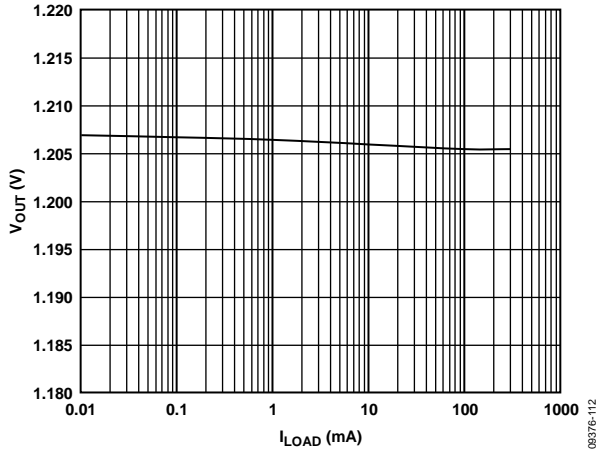

Figure 12. Output Voltage vs. Load Current, $V_{OUTx} = 1.2\text{ V}$, ADP222/ADP224

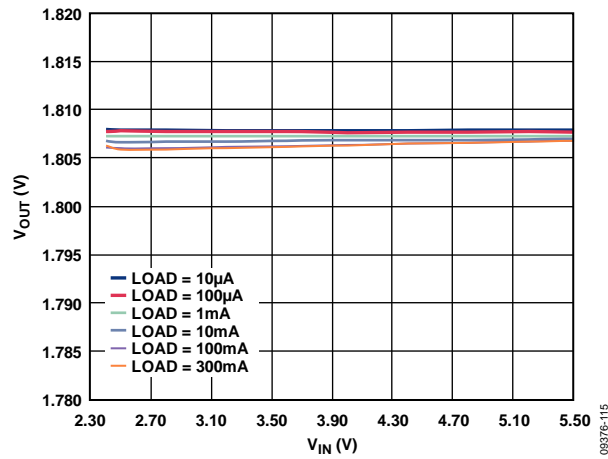

Figure 15. Output Voltage vs. Input Voltage, $V_{OUTx} = 1.8\text{ V}$, ADP222/ADP224

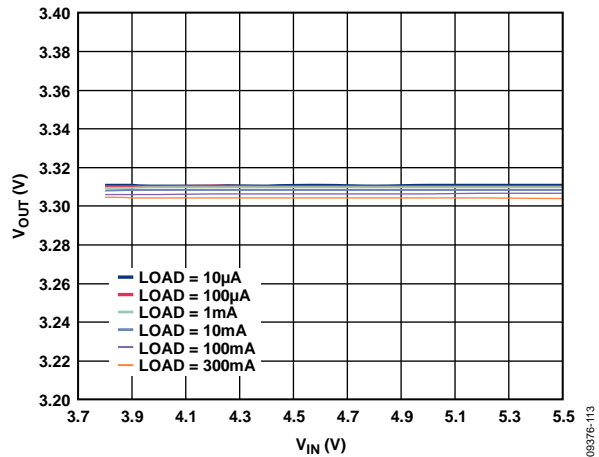

Figure 13. Output Voltage vs. Input Voltage, $V_{OUTx} = 3.3\text{ V}$, ADP222/ADP224

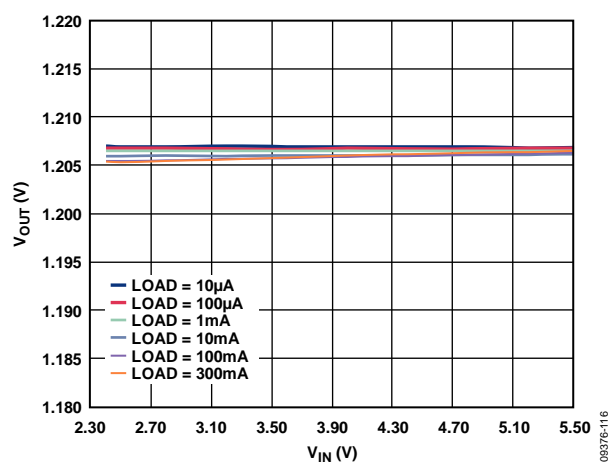

Figure 16. Output Voltage vs. Input Voltage, $V_{OUTx} = 1.2\text{ V}$, ADP222/ADP224

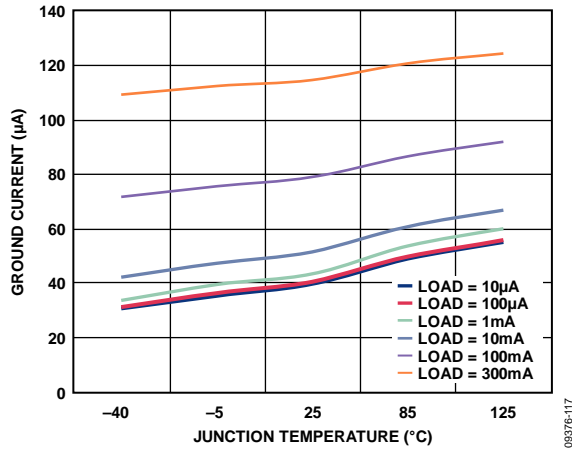

Figure 17. Ground Current vs. Junction Temperature, Single Output, ADP222/ADP224

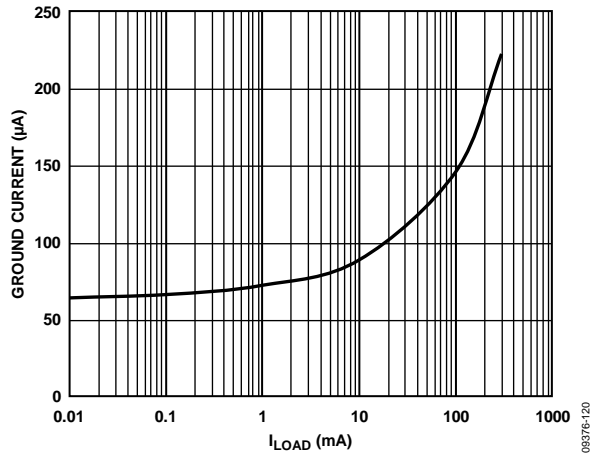

Figure 20. Ground Current vs. Load Current, Dual Output, ADP222/ADP224

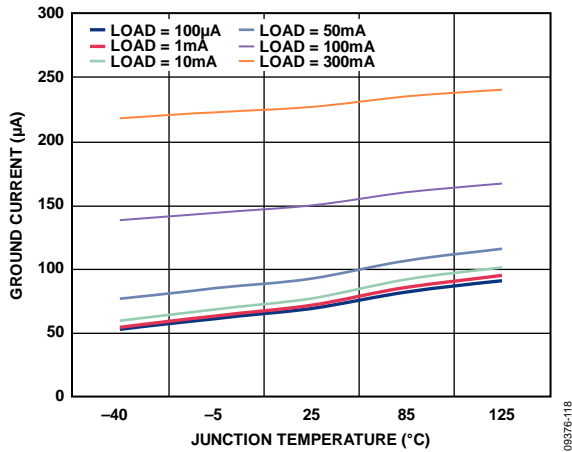

Figure 18. Ground Current vs. Junction Temperature, Dual Output, ADP222/ADP224

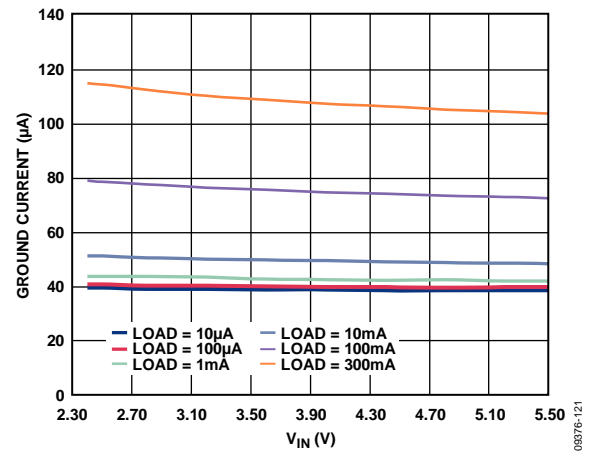

Figure 21. Ground Current vs. Input Voltage, $V_{OUTx} = 1.2V$, ADP222/ADP224

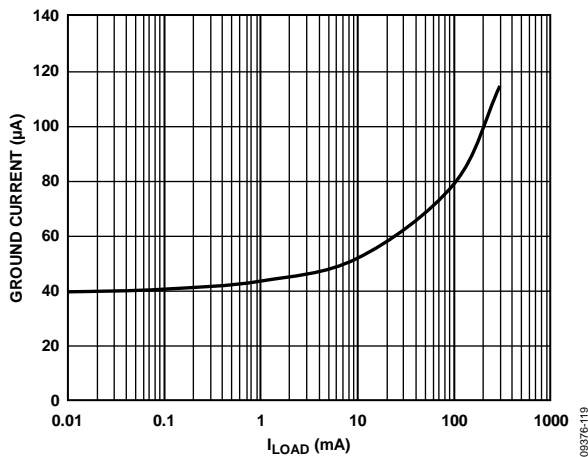

Figure 19. Ground Current vs. Load Current, Single Output, ADP222/ADP224

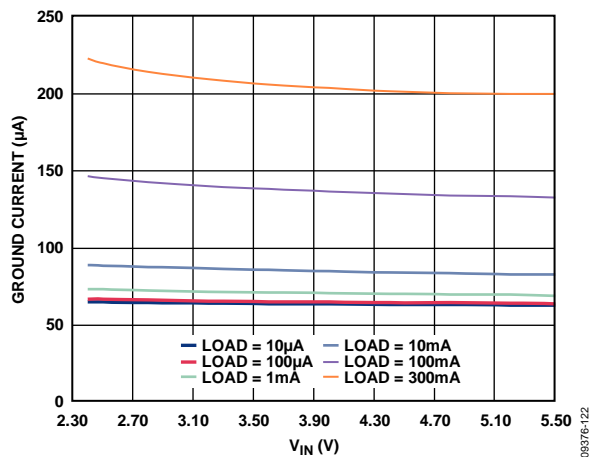

Figure 22. Ground Current vs. Input Voltage, $V_{OUTx} = 1.2V$ and $1.8V$, ADP222/ADP224

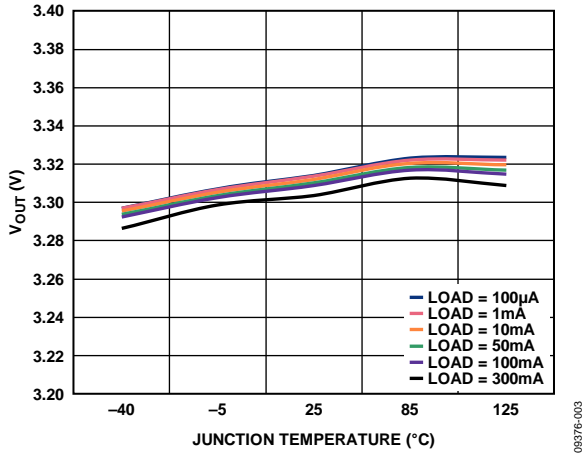

Figure 23. Output Voltage vs. Junction Temperature, $V_{OUTx} = 3.3\text{ V}$, ADP223/ADP225

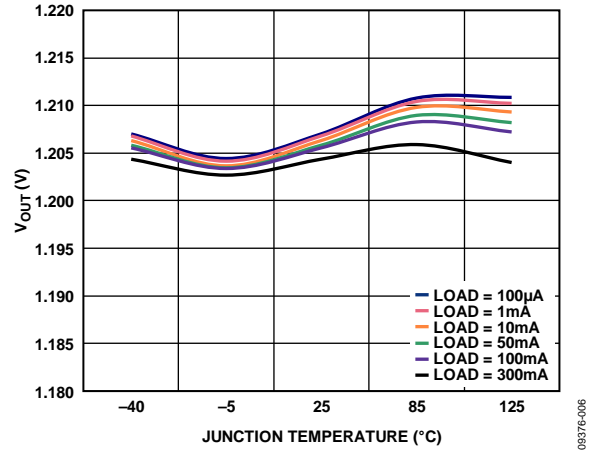

Figure 26. Output Voltage vs. Junction Temperature, $V_{OUTx} = 1.2\text{ V}$, ADP223/ADP225

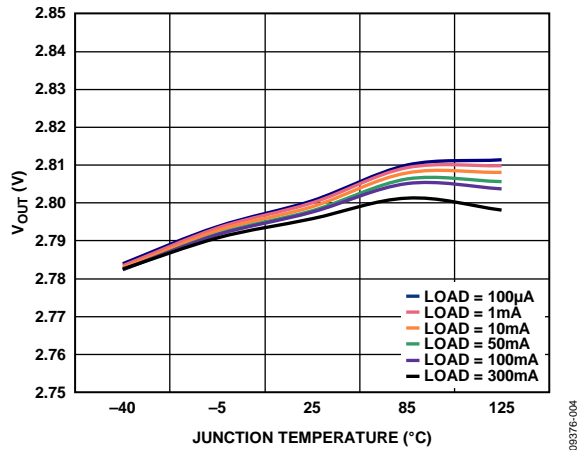

Figure 24. Output Voltage vs. Junction Temperature, $V_{OUTx} = 2.8\text{ V}$, ADP223/ADP225

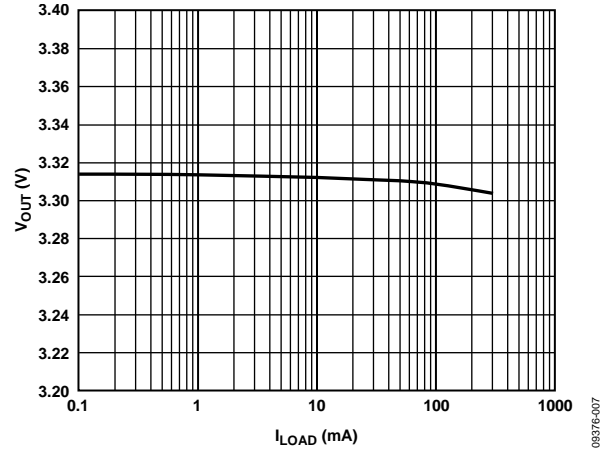

Figure 27. Output Voltage vs. Load Current, $V_{OUTx} = 3.3\text{ V}$, ADP223/ADP225

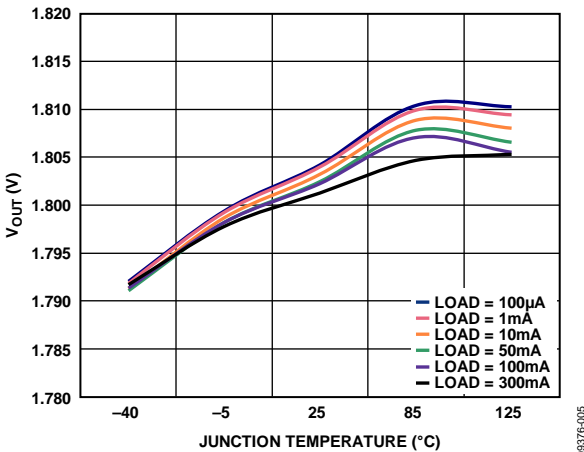

Figure 25. Output Voltage vs. Junction Temperature, $V_{OUTx} = 1.8\text{ V}$, ADP223/ADP225

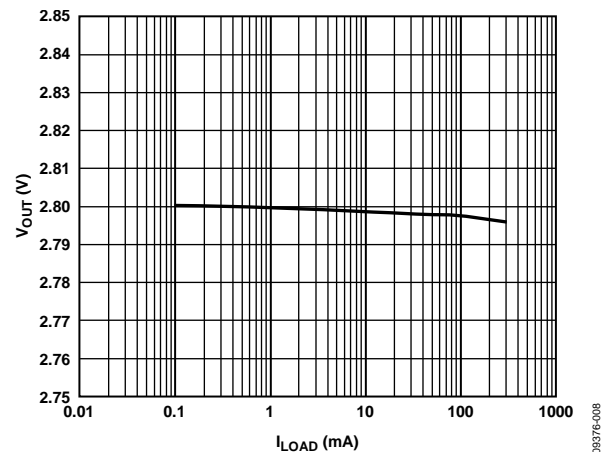

Figure 28. Output Voltage vs. Load Current, $V_{OUTx} = 2.8\text{ V}$, ADP223/ADP225

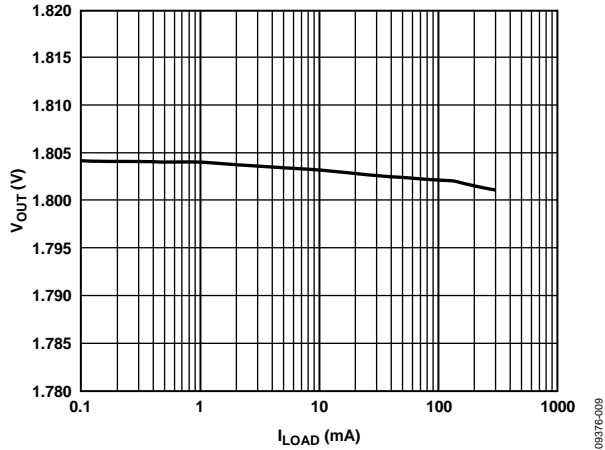

Figure 29. Output Voltage vs. Load Current, $V_{OUTx} = 1.8\text{ V}$, ADP223/ADP225

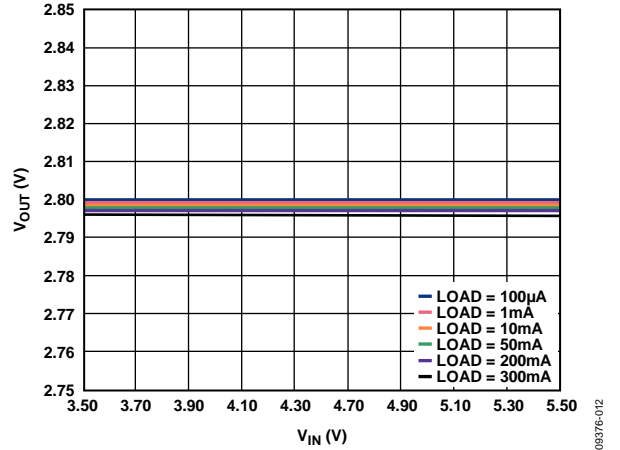

Figure 32. Output Voltage vs. Input Voltage, $V_{OUTx} = 2.8\text{ V}$, ADP223/ADP225

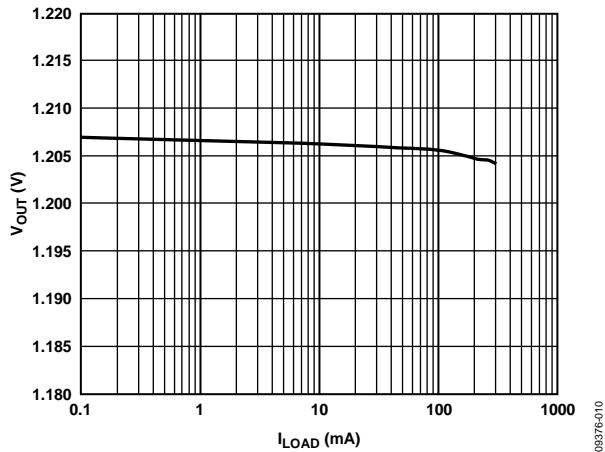

Figure 30. Output Voltage vs. Load Current, $V_{OUTx} = 1.2\text{ V}$, ADP223/ADP225

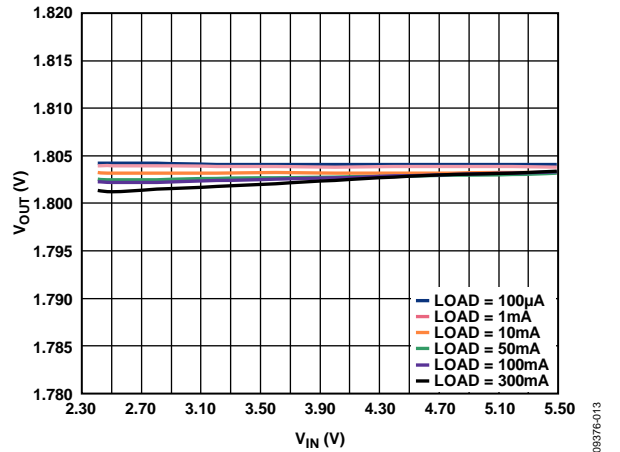

Figure 33. Output Voltage vs. Input Voltage, $V_{OUTx} = 1.8\text{ V}$, ADP223/ADP225

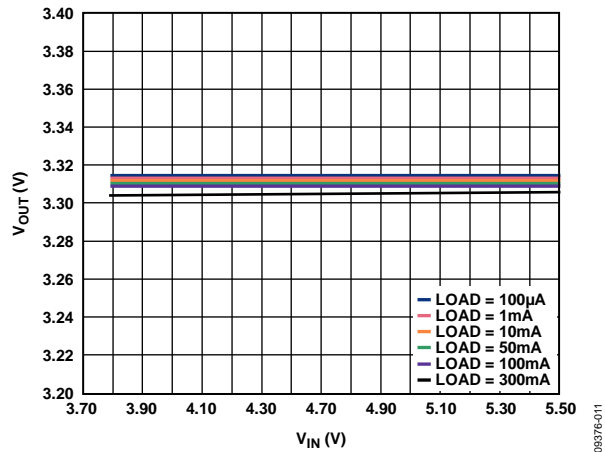

Figure 31. Output Voltage vs. Input Voltage, $V_{OUTx} = 3.3\text{ V}$, ADP223/ADP225

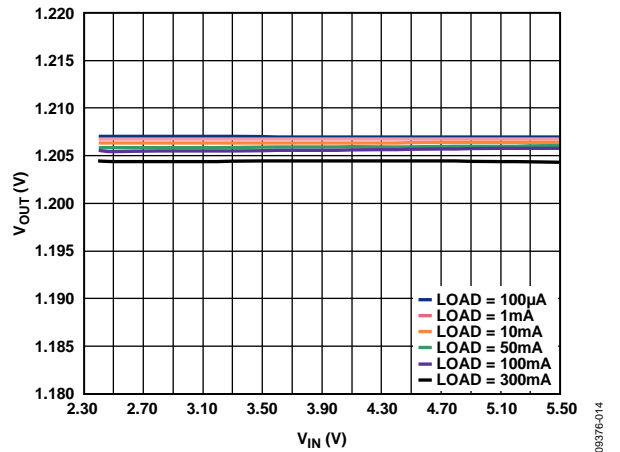
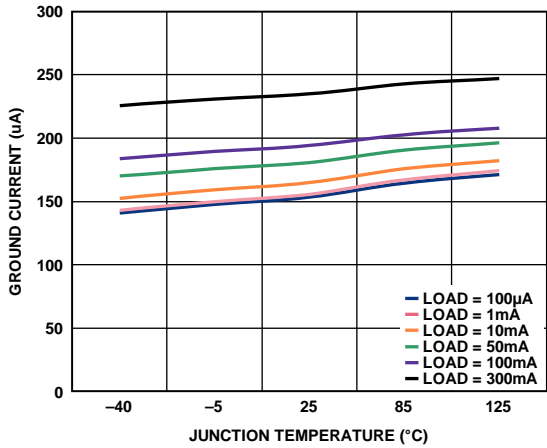
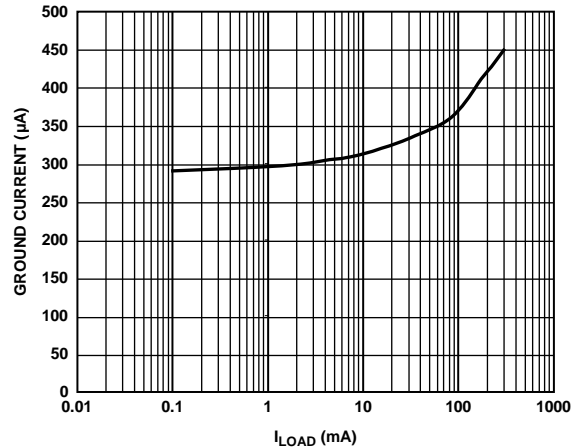

Figure 34. Output Voltage vs. Input Voltage, $V_{OUTx} = 1.2\text{ V}$, ADP223/ADP225



08376-015

Figure 35. Ground Current vs. Junction Temperature, Single Output, Includes 100 µA for Output Divider, ADP223/ADP225



08376-018

Figure 38. Ground Current vs. Load Current, Dual Output, Includes 200 µA for Output Dividers, ADP223/ADP225

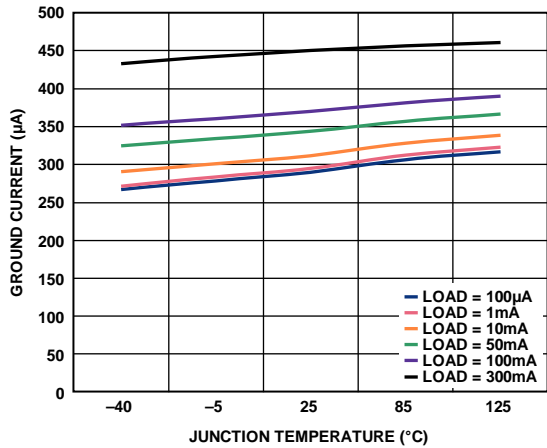

08376-016

Figure 36. Ground Current vs. Junction Temperature, Dual Output, Includes 200 µA for Output Dividers, ADP223/ADP225

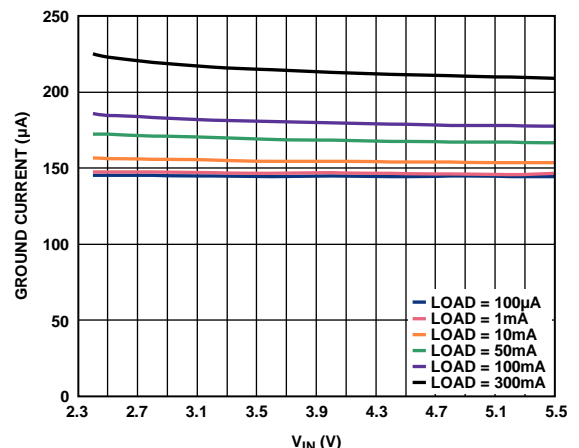

08376-019

Figure 39. Ground Current vs. Input Voltage, $V_{OUTx} = 1.2$ V, Single Output, Includes 100 µA for Output Divider, ADP223/ADP225

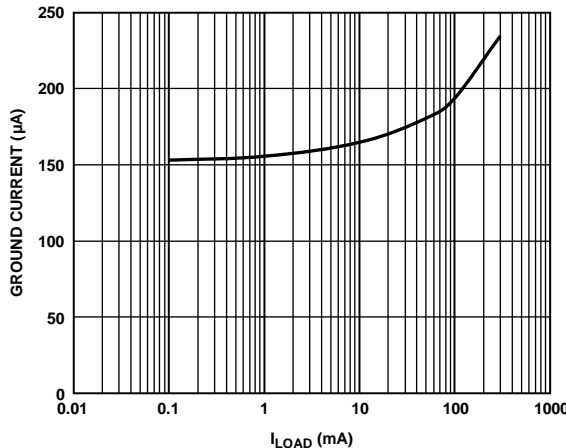

08376-017

Figure 37. Ground Current vs. Load Current, Single Output, Includes 100 µA for Output Divider, ADP223/ADP225

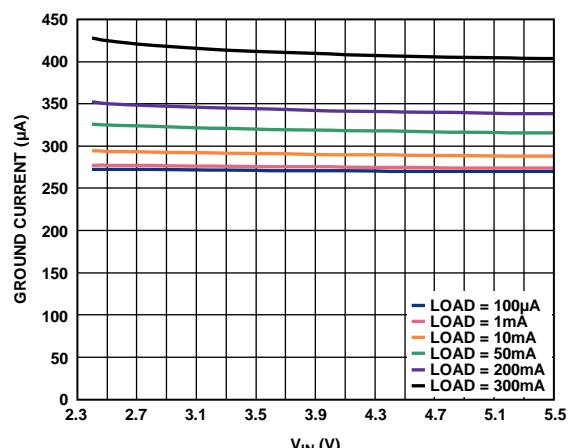

08376-020

Figure 40. Ground Current vs. Input Voltage, $V_{OUTx} = 1.2$ V and 1.8 V, Dual Output, Includes 200 µA for Output Dividers, ADP223/ADP225

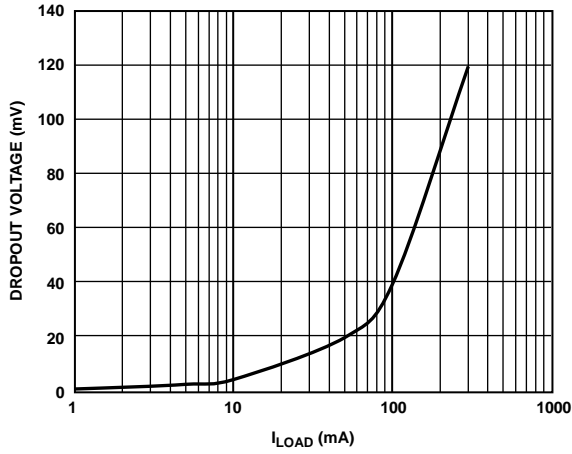

Figure 41. Dropout Voltage vs. Load Current, $V_{OUT} = 3.3\text{ V}$

09376-021

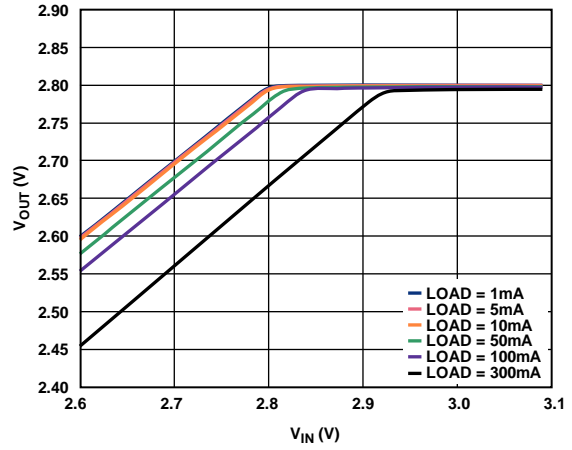

Figure 44. Output Voltage vs. Input Voltage in Dropout, $V_{OUTx} = 2.8\text{ V}$

09376-024

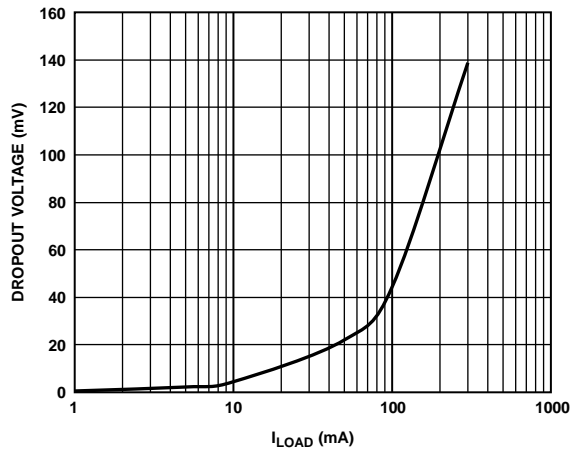

Figure 42. Dropout Voltage vs. Load Current, $V_{OUT} = 2.8\text{ V}$

09376-022

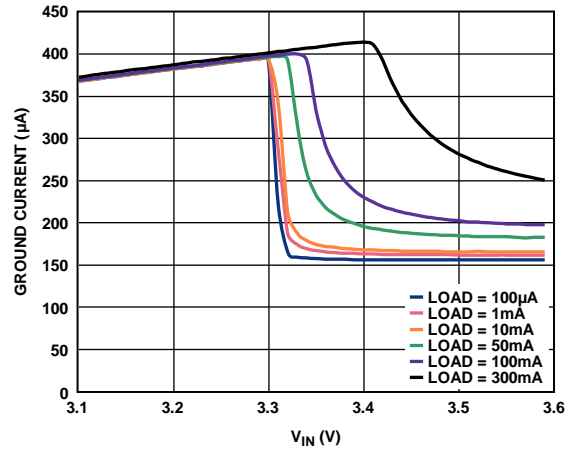

Figure 45. Ground Current vs. Input Voltage in Dropout, $V_{OUTx} = 3.3\text{ V}$

09376-025

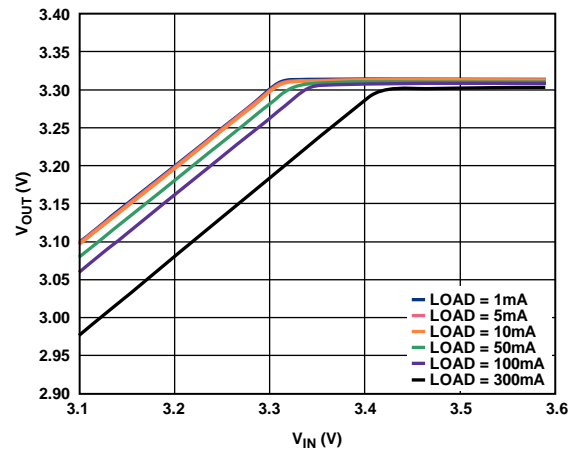

Figure 43. Output Voltage vs. Input Voltage in Dropout, $V_{OUTx} = 3.3\text{ V}$

09376-023

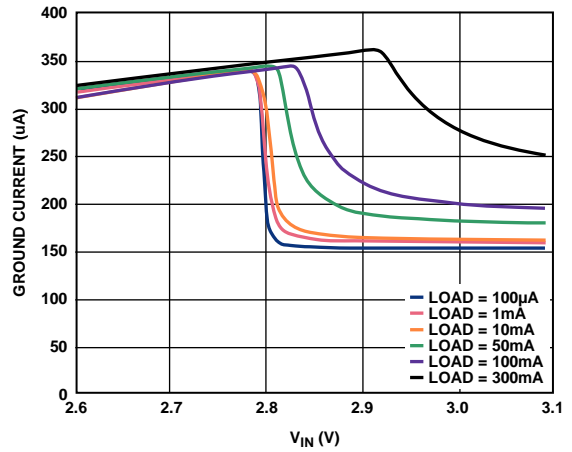

Figure 46. Ground Current vs. Input Voltage in Dropout, $V_{OUTx} = 2.8\text{ V}$

09376-026

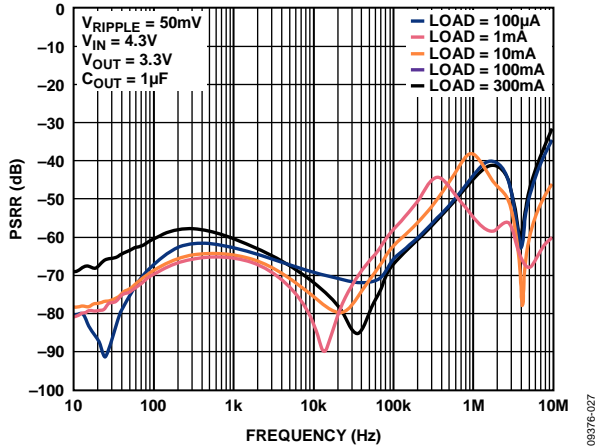

Figure 47. Power Supply Rejection Ratio vs. Frequency, $V_{IN} = 4.3V$, $V_{OUTx} = 3.3V$

09376-027

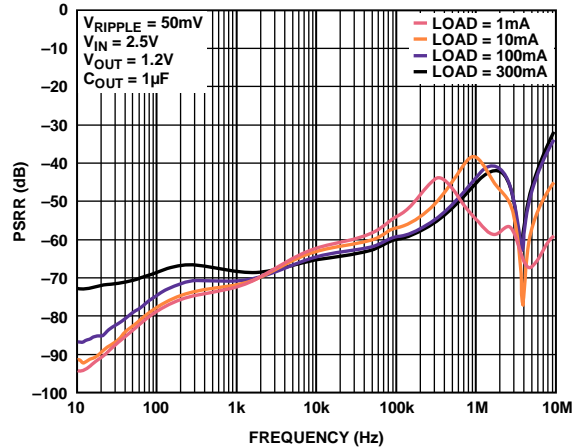

Figure 50. Power Supply Rejection Ratio vs. Frequency, $V_{IN} = 2.5V$, $V_{OUTx} = 1.2V$

09376-030

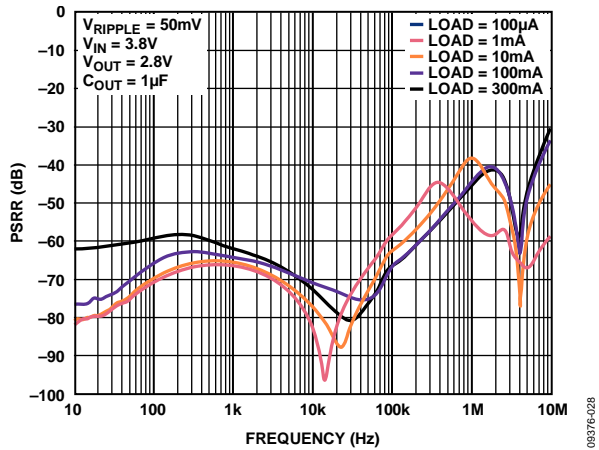

Figure 48. Power Supply Rejection Ratio vs. Frequency, $V_{IN} = 3.8V$, $V_{OUTx} = 2.8V$

09376-028

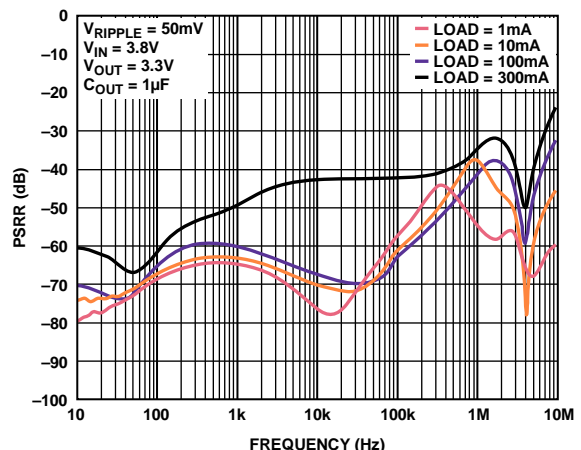

Figure 51. Power Supply Rejection Ratio vs. Frequency, $V_{IN} = 3.8V$, $V_{OUTx} = 3.3V$

09376-031

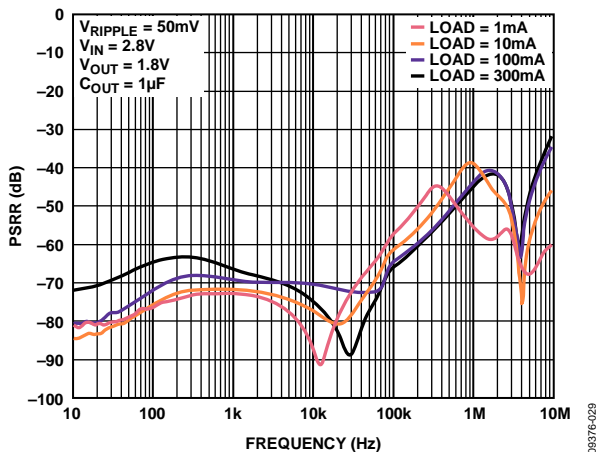

Figure 49. Power Supply Rejection Ratio vs. Frequency, $V_{IN} = 2.8V$, $V_{OUTx} = 1.8V$

09376-029

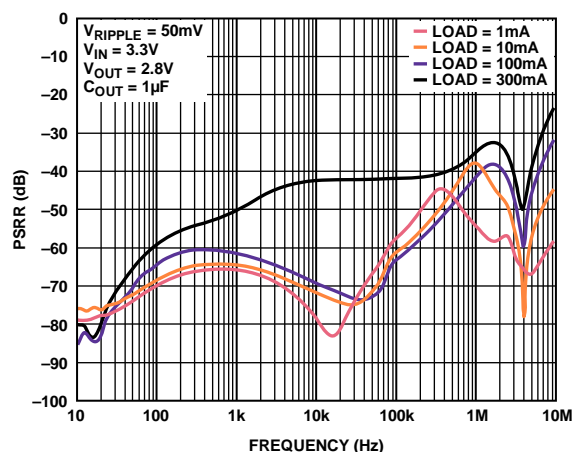

Figure 52. Power Supply Rejection Ratio vs. Frequency, $V_{IN} = 3.3V$, $V_{OUTx} = 2.8V$

09376-032

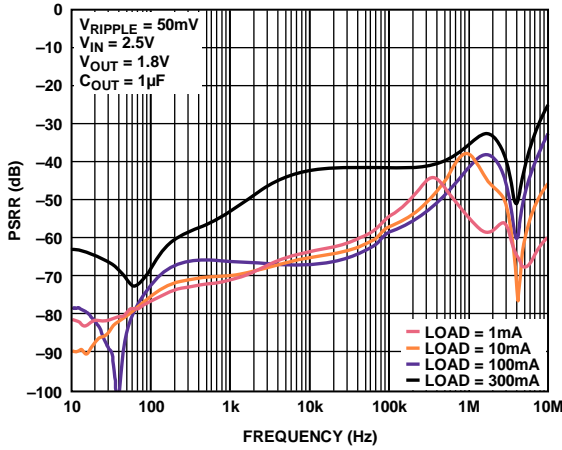

Figure 53. Power Supply Rejection Ratio vs. Frequency, $V_{IN} = 2.5V$, $V_{OUTX} = 1.8V$

08376-033

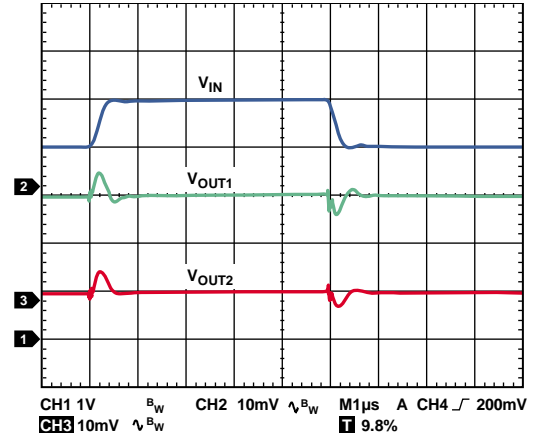

Figure 56. Transient Line Response, $V_{OUTX} = 3.3V$ and $2.8V$, $V_{IN} = 4V$ to $5V$, $I_{LOAD} = 300mA$

08376-036

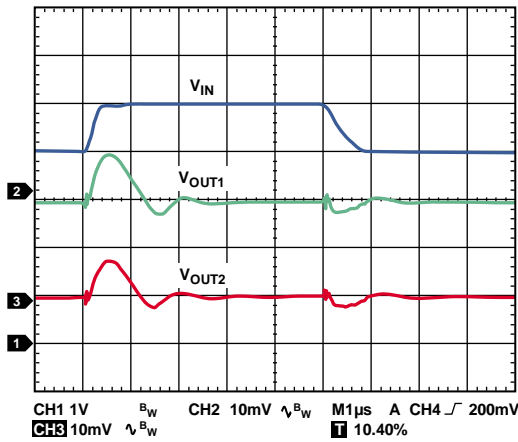

Figure 54. Transient Line Response, $V_{OUTX} = 3.3V$ and $2.8V$, $V_{IN} = 4V$ to $5V$, $I_{LOAD} = 10mA$

08376-034

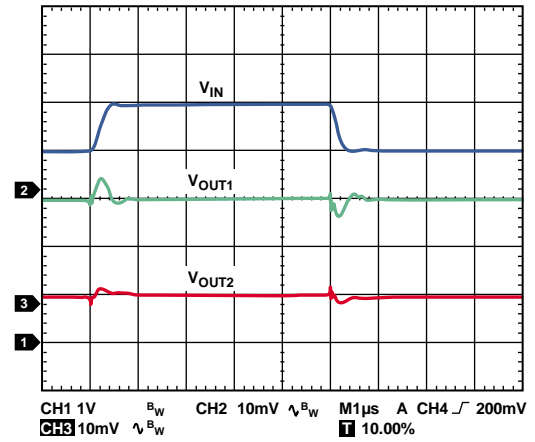

Figure 57. Transient Line Response, $V_{OUTX} = 1.2V$ and $1.8V$, $V_{IN} = 4V$ to $5V$, $I_{LOAD} = 300mA$

08376-037

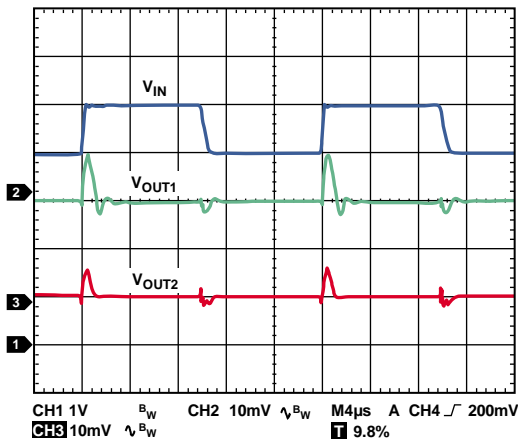

Figure 55. Transient Line Response, $V_{OUTX} = 1.2V$ and $1.8V$, $V_{IN} = 4V$ to $5V$, $I_{LOAD} = 10mA$

08376-035

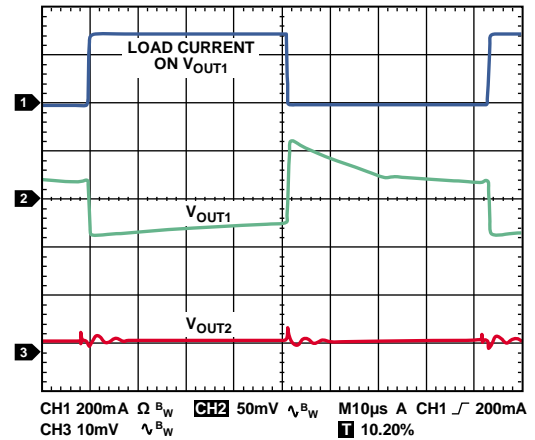

Figure 58. Transient Load Response, $V_{OUTX} = 3.3V$, $I_{LOAD} = 1mA$ to $300mA$; $V_{OUTX} = 2.8V$, $I_{LOAD} = 1mA$

08376-038

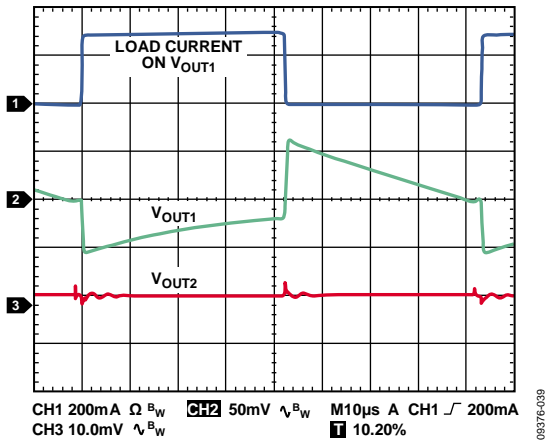

Figure 59. Transient Load Response, $V_{OUTX} = 1.2\text{ V}$, $I_{LOAD} = 1\text{ mA}$ to 300 mA ;
 $V_{OUTX} = 1.8\text{ V}$, $I_{LOAD} = 1\text{ mA}$

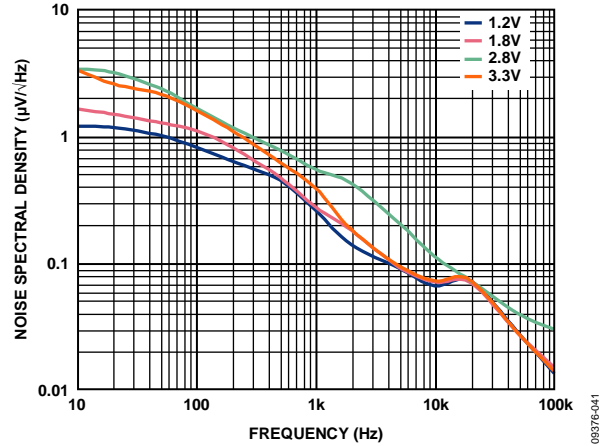

Figure 61. Output Noise Spectral Density, $V_{IN} = 5\text{ V}$, $I_{LOAD} = 10\text{ mA}$, $C_{OUT} = 1\text{ }\mu\text{F}$

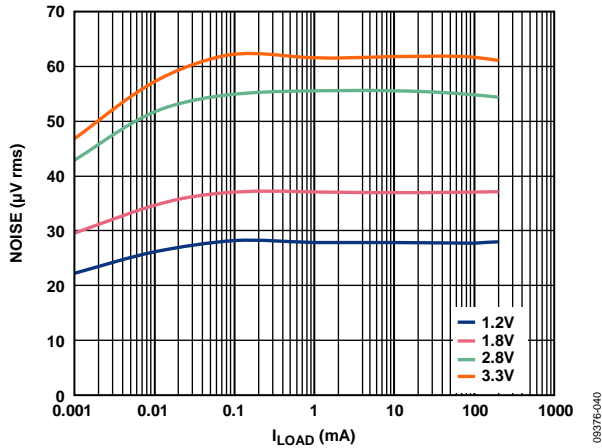

Figure 60. RMS Output Noise vs. Load Current and Output Voltage,
 $V_{IN} = 5\text{ V}$, $C_{OUT} = 1\text{ }\mu\text{F}$

THEORY OF OPERATION

The [ADP222/ADP223/ADP224/ADP225](#) are low quiescent current, fixed and adjustable dual output, low dropout linear regulators that operate from 2.5 V to 5.5 V and provide up to 300 mA of current from each output. Drawing a low 300 μ A quiescent current (typical) at full load make the [ADP222/ADP223/ADP224/ADP225](#) ideal for battery-operated portable equipment. Shutdown current consumption is typically 200 nA. Optimized for use with small 1 μ F ceramic capacitors, the [ADP222/ADP223/ADP224/ADP225](#) provide excellent transient performance.

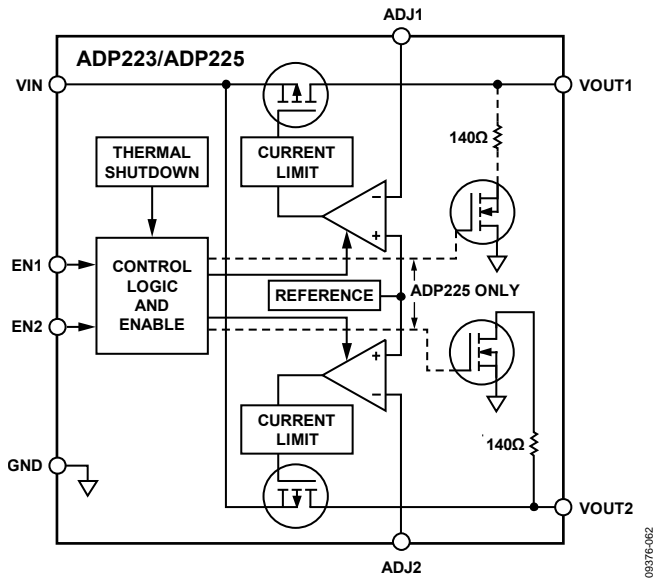

Figure 62. Internal Block Diagram, [ADP223/ADP225](#)

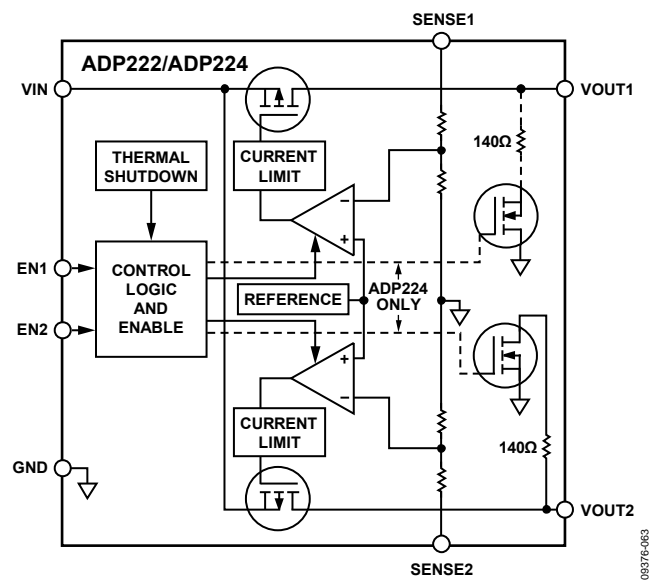

Figure 63. Internal Block Diagram, [ADP222/ADP224](#)

Internally, the [ADP222/ADP223/ADP224/ADP225](#) consist of a reference, two error amplifiers, and two PMOS pass transistors. Output current is delivered via the PMOS pass device, which is

controlled by the error amplifier. The error amplifier compares the reference voltage with the feedback voltage from the output and amplifies the difference. If the feedback voltage is lower than the reference voltage, the gate of the PMOS device is pulled lower, allowing more current to flow and increasing the output voltage. If the feedback voltage is higher than the reference voltage, the gate of the PMOS device is pulled higher, allowing less current to flow and decreasing the output voltage.

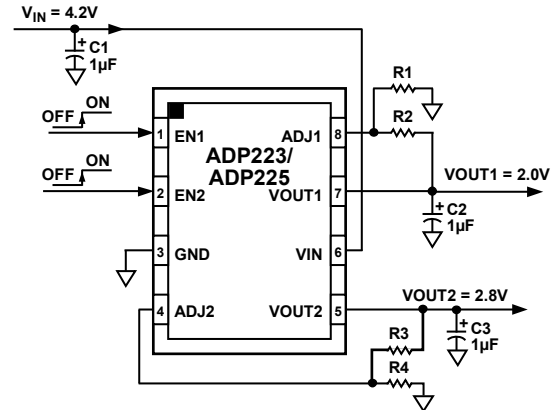

Figure 64. Typical Application Circuit for Setting Output Voltages, [ADP223/ADP225](#)

The [ADP223/ADP225](#) are exactly the same as the [ADP222/ADP224](#) except that the output voltage dividers are internally disconnected and the feedback input of the error amplifiers is brought out for each output. The output voltages can be set according to the following equations:

$$V_{OUT1} = 0.50 V(1 + R2/R1)$$

$$V_{OUT2} = 0.50 V(1 + R3/R4)$$

The value of R1 and R4 should be less than 200 k Ω to minimize errors in the output voltage caused by the ADJx pin input current. For example, when R1 and R2 each equal 200 k Ω , the output voltage is 1.0 V. The output voltage error introduced by the ADJx pin input current is 2 mV or 0.20%, assuming a typical ADJx pin input current of 10 nA at 25°C.

The output voltage of the [ADP223/ADP225](#) may be set from 0.5 V to 5.0 V.

The [ADP222/ADP224](#) are available in multiple output voltage options ranging from 0.8 V to 3.3 V.

The [ADP224/ADP225](#) are identical to the [ADP222/ADP223](#) with the addition of a quick output discharge (QOD) feature. This allows the output voltage to start up from a known state.

The [ADP222/ADP223/ADP224/ADP225](#) use the EN1/EN2 pins to enable and disable the VOUT1/VOUT2 pins under normal operating conditions. When EN1/EN2 are high, VOUT1/VOUT2 turn on; when EN1/EN2 are low, VOUT1/VOUT2 turn off. For automatic startup, EN1/EN2 can be tied to VIN.

APPLICATIONS INFORMATION

CAPACITOR SELECTION

Output Capacitor

The ADP222/ADP223/ADP224/ADP225 are designed for operation with small, space-saving ceramic capacitors but function with most commonly used capacitors as long as care is taken with regard to the effective series resistance (ESR) value. The ESR of the output capacitor affects the stability of the LDO control loop. A minimum of 0.7 μF capacitance with an ESR of 1 Ω or less is recommended to ensure the stability of the ADP222/ADP223/ADP224/ADP225. Transient response to changes in load current is also affected by output capacitance. Using a larger value of output capacitance improves the transient response of the ADP222/ADP223/ADP224/ADP225 to large changes in load current. Figure 65 shows the transient responses for an output capacitance value of 1 μF .

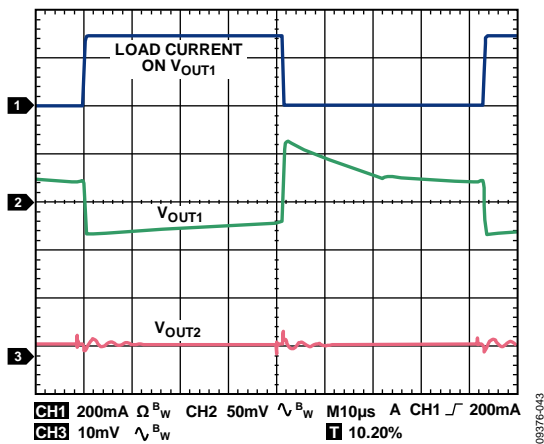

Figure 65. Output Transient Response, $C_{OUT} = 1 \mu\text{F}$

Input Bypass Capacitor

Connecting a 1 μF capacitor from VIN to GND reduces the circuit sensitivity to the printed circuit board (PCB) layout, especially when long input traces or high source impedance are encountered. If greater than 1 μF of output capacitance is required, the input capacitor should be increased to match it.

Input and Output Capacitor Properties

Any good quality ceramic capacitors can be used with the ADP222/ADP223/ADP224/ADP225, as long as they meet the minimum capacitance and maximum ESR requirements. Ceramic capacitors are manufactured with a variety of dielectrics, each with different behavior over temperature and applied voltage. Capacitors must have a dielectric adequate to ensure the minimum capacitance over the necessary temperature range and dc bias conditions. X5R or X7R dielectrics with a voltage rating of 6.3 V or 10 V are recommended, but Y5V and Z5U dielectrics are not recommended, due to their poor temperature and dc bias characteristics.

Figure 66 depicts the capacitance vs. voltage bias characteristic of an 0402, 1 μF , 10 V, X5R capacitor. The voltage stability of a capacitor is strongly influenced by the capacitor size and voltage rating. In general, a capacitor in a larger package or higher voltage rating exhibits better stability. The temperature variation of the X5R dielectric is $\sim\pm 15\%$ over the -40°C to $+85^\circ\text{C}$ temperature range and is not a function of package or voltage rating.

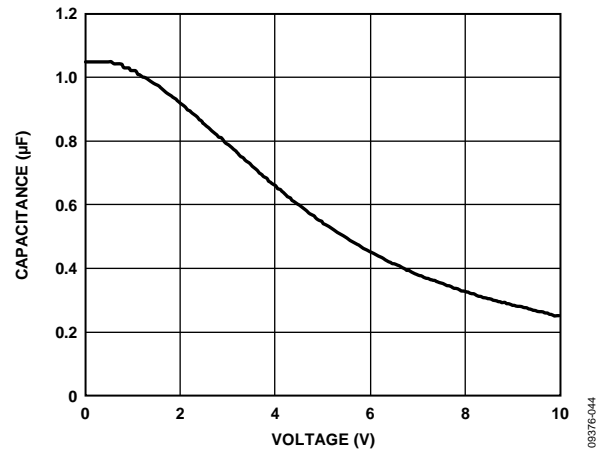

Figure 66. Capacitance vs. Voltage Bias Characteristic

Use Equation 1 to determine the worst-case capacitance accounting for capacitor variation over temperature, component tolerance, and voltage.

$$C_{EFF} = C_{BIAS} \times (1 - TEMPCO) \times (1 - TOL) \quad (1)$$

where:

C_{BIAS} is the effective capacitance at the operating voltage.

$TEMPCO$ is the worst-case capacitor temperature coefficient.

TOL is the worst-case component tolerance.

In this example, the worst-case temperature coefficient ($TEMPCO$) over -40°C to $+85^\circ\text{C}$ is assumed to be 15% for an X5R dielectric. The tolerance of the capacitor (TOL) is assumed to be 10%, and C_{BIAS} is 0.94 μF at 1.8 V, as shown in Figure 66.

Substituting these values in Equation 1 yields

$$C_{EFF} = 0.94 \mu\text{F} \times (1 - 0.15) \times (1 - 0.1) = 0.719 \mu\text{F}$$

Therefore, the capacitor chosen in this example meets the minimum capacitance requirement of the LDO over temperature and tolerance at the chosen output voltage.

To guarantee the performance of the ADP222/ADP223/ADP224/ADP225, it is imperative that the effects of dc bias, temperature, and tolerances on the behavior of the capacitors be evaluated for each application.

ENABLE FEATURE

The ADP222/ADP223/ADP224/ADP225 use the ENx pins to enable and disable the VOUTx pins under normal operating conditions. Figure 67 shows a rising voltage on ENx crossing the active threshold, where VOUTx turns on. When a falling voltage on ENx crosses the inactive threshold, VOUTx turns off.

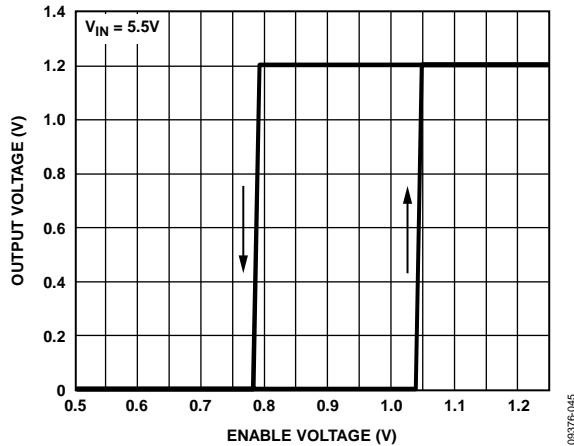

Figure 67. Typical ENx Pin Operation, VIN = 5.5 V

As shown in Figure 67, the ENx pins have built-in hysteresis. This prevents on/off oscillations that can occur due to noise on the ENx pins as it passes through the threshold points.

The active/inactive thresholds of the ENx pins are derived from the VIN voltage. Therefore, these thresholds vary with changing input voltage. Figure 68 shows typical ENx active/inactive thresholds when the input voltage varies from 2.5 V to 5.5 V.

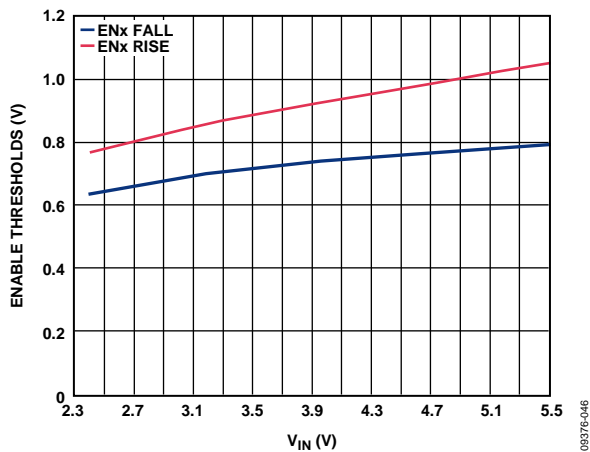

Figure 68. Typical Enable Thresholds vs. Input Voltage

The ADP222/ADP223/ADP224/ADP225 use an internal soft start to limit the inrush current when the output is enabled. The start-up time for the 2.8 V option is approximately 240 μs from the time the ENx active threshold is crossed to when the output reaches 90% of its final value. The start-up time is somewhat dependent on the output voltage setting and increases slightly as the output voltage increases.

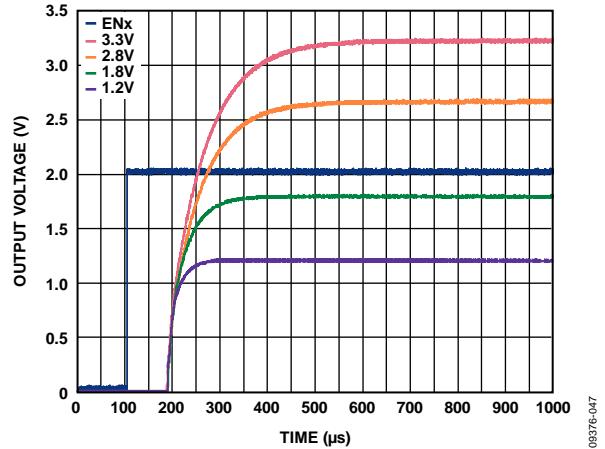

Figure 69. Typical Start-Up Time

QUICK OUTPUT DISCHARGE (QOD) FUNCTION

The ADP224/ADP225 include an output discharge resistor to force the voltage on each output to zero when the respective LDO is disabled. This ensures that the outputs of the LDOs are always in a well-defined state, regardless if it is enabled or not. The ADP222/ADP223 do not include the output discharge function. Figure 70 compares the turn-off time of a 3.3 V output LDO with and without the QOD function. Both LDOs have a 1 kΩ resistor connected to each output. The LDO with the QOD function discharges the output to 0 V in less than 1 ms, whereas the 1 kΩ load takes over 5 ms to do the same.

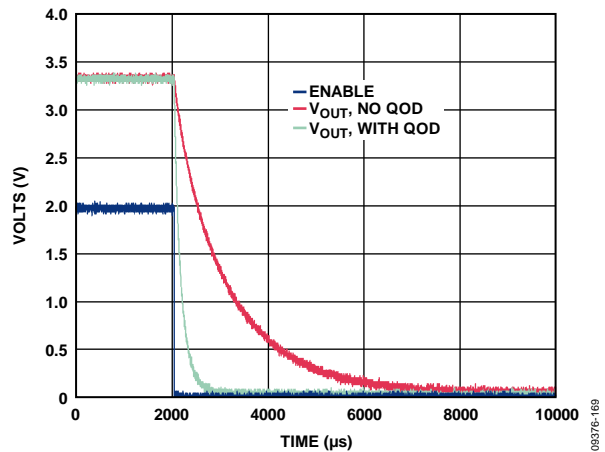

Figure 70. Typical Turn-Off Time with and Without QOD Function

CURRENT LIMIT AND THERMAL OVERLOAD PROTECTION

The ADP222/ADP223/ADP224/ADP225 are protected against damage due to excessive power dissipation by current and thermal overload protection circuits. The ADP222/ADP223/ADP224/ADP225 are designed to current limit when the output load reaches 300 mA (typical). When the output load exceeds 300 mA, the output voltage is reduced to maintain a constant current limit.

Thermal overload protection is included, which limits the junction temperature to a maximum of 155°C (typical). Under extreme conditions (that is, high ambient temperature and power dissipation) when the junction temperature starts to rise above 155°C, the output is turned off, reducing the output current to 0. When the junction temperature drops below 140°C, the output is turned on again, and output current is restored to its nominal value.

Consider the case where a hard short from VOUTx to ground occurs. At first, the ADP222/ADP223/ADP224/ADP225 current limits, so that only 300 mA is conducted into the short. If self-heating of the junction is great enough to cause its temperature to rise above 155°C, thermal shutdown activates, turning off the output and reducing the output current to 0 mA. As the junction temperature cools and drops below 140°C, the output turns on and conducts 300 mA into the short, again causing the junction temperature to rise above 155°C. This thermal oscillation between 140°C and 155°C causes a current oscillation between 300 mA and 0 mA that continues as long as the short remains at the output.

Current and thermal limit protections are intended to protect the device against accidental overload conditions. For reliable operation, device power dissipation must be externally limited so that junction temperatures do not exceed 125°C.

THERMAL CONSIDERATIONS

In most applications, the ADP222/ADP223/ADP224/ADP225 do not dissipate much heat due to its high efficiency. However, in applications with high ambient temperature, and high supply voltage to output voltage differential, the heat dissipated in the package is large enough that it can cause the junction temperature of the die to exceed the maximum junction temperature of 125°C.

When the junction temperature exceeds 155°C, the converter enters thermal shutdown. It recovers only after the junction temperature has decreased below 140°C to prevent any permanent damage. Therefore, thermal analysis for the chosen application is very important to guarantee reliable performance over all conditions. The junction temperature of the die is the sum of the ambient temperature of the environment and the temperature rise of the package due to the power dissipation, as shown in Equation 2.

To guarantee reliable operation, the junction temperature of the ADP222/ADP223/ADP224/ADP225 must not exceed 125°C. To ensure that the junction temperature stays below this maximum value, the user must be aware of the parameters that contribute to junction temperature changes. These parameters include ambient temperature, power dissipation in the power device, and thermal resistances between the junction and ambient air (θ_{JA}). The θ_{JA} number is dependent on the package assembly compounds that are used and the amount of copper used to solder the package GND pin to the PCB.

Table 6 shows typical θ_{JA} values of the 8-lead LFCSP package for various PCB copper sizes, and Table 7 shows the typical Ψ_{JB} value of the 8-lead LFCSP.

Table 6. Typical θ_{JA} Values

Copper Size (mm ²)	θ_{JA} (°C/W)
25 ¹	175.1
100	135.6
500	77.3
1000	65.2
6400	51

¹ Device soldered to minimum size pin traces.

Table 7. Typical Ψ_{JB} Value

Model	Ψ_{JB} (°C/W)
8-Lead LFCSP	18.2

The junction temperature of the ADP222/ADP223/ADP224/ADP225 can be calculated by

$$T_J = T_A + (P_D \times \theta_{JA}) \tag{2}$$

where:

T_A is the ambient temperature.

P_D is the power dissipation in the die, given by

$$P_D = [(V_{IN} - V_{OUT}) \times I_{LOAD}] + (V_{IN} \times I_{GND})$$

where:

I_{LOAD} is the load current.

I_{GND} is the ground current.

V_{IN} and V_{OUT} are input and output voltages, respectively.

Power dissipation due to ground current is quite small and can be ignored. Therefore, the junction temperature equation simplifies to the following:

$$T_J = T_A + \{[(V_{IN} - V_{OUT}) \times I_{LOAD}] \times \theta_{JA}\}$$

As shown in the simplified equation, for a given ambient temperature, input- to-output voltage differential, and continuous load current, there exists a minimum copper size requirement for the PCB to ensure that the junction temperature does not rise above 125°C. Figure 71 to Figure 74 show junction temperature calculations for different ambient temperatures, power dissipation, and areas of PCB copper.

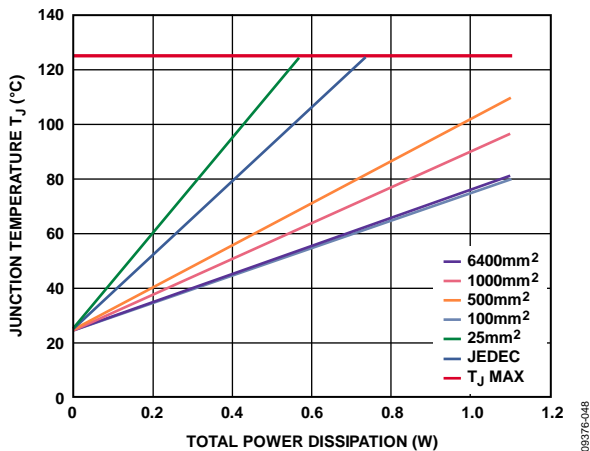

Figure 71. 8-Lead LFCSP, $T_A = 25^\circ\text{C}$

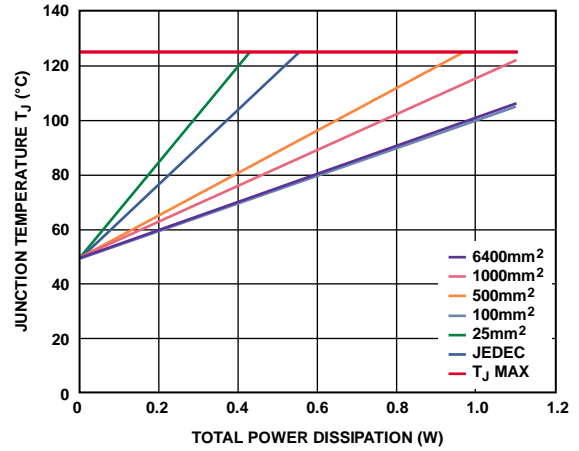

Figure 72. 8-Lead LFCSP, $T_A = 50^\circ\text{C}$

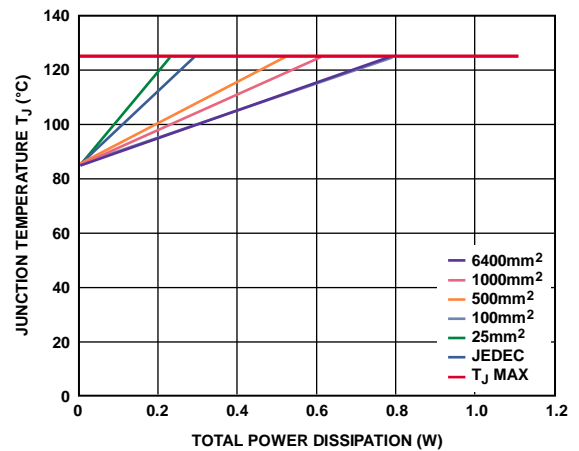

Figure 73. 8-Lead LFCSP, $T_A = 85^\circ\text{C}$

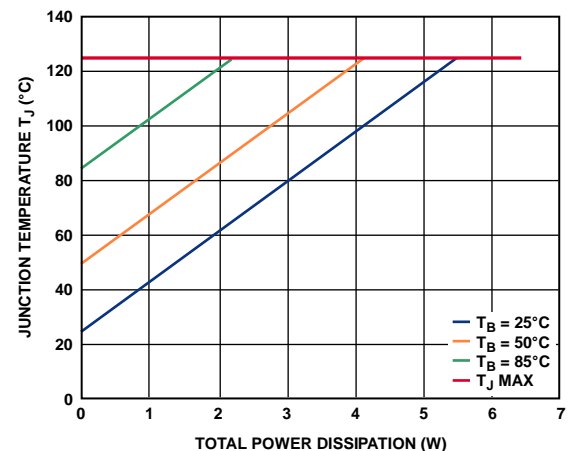

Figure 74. 8-Lead LFCSP, $T_A = 85^\circ\text{C}$

In the case where the board temperature is known, use the thermal characterization parameter, Ψ_{JB} , to estimate the junction temperature rise (see Figure 74). Maximum junction temperature (T_J) is calculated from the board temperature (T_B) and power dissipation (P_D) using the following formula:

$$T_J = T_B + (P_D \times \Psi_{JB}) \tag{3}$$

The typical value of Ψ_{JB} is 18.2°C/W for the 8-lead LFCSP package.

PRINTED CIRCUIT BOARD LAYOUT CONSIDERATIONS

Heat dissipation from the package can be improved by increasing the amount of copper attached to the pins of the [ADP222/ADP223/ADP224/ADP225](#). However, as listed in Table 6, a point of diminishing returns is eventually reached beyond which an increase in the copper size does not yield significant heat dissipation benefits.

Place the input capacitor as close as possible to the VIN and GND pins. Place the output capacitor as close as possible to the VOUTx and GND pins. Use of 0402 or 0603 size capacitors and resistors achieves the smallest possible footprint solution on boards where area is limited.

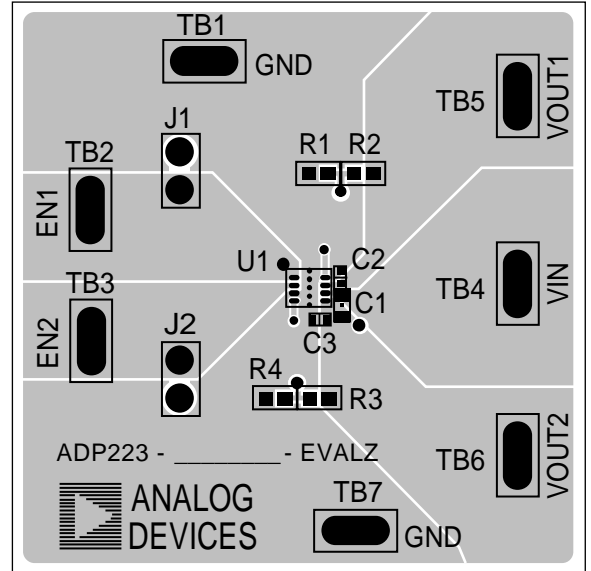

Figure 75. Example 8-Lead LFCSP PCB Layout

OUTLINE DIMENSIONS

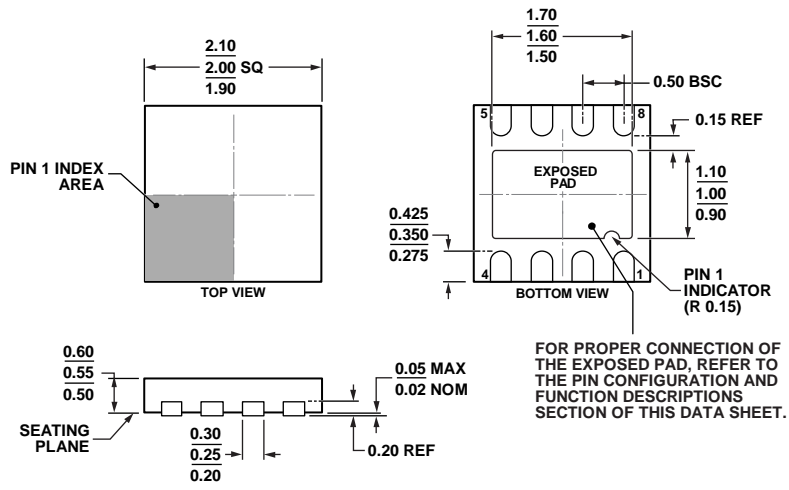

Figure 76. 8-Lead Lead Frame Chip Scale Package [LFCSP_UD]
 2.00 mm × 2.00 mm Body, Ultra Thin, Dual Lead
 (CP-8-10)
 Dimensions shown in millimeters

01-14-2013-C

ORDERING GUIDE

Model ¹	Temperature Range	Output Voltage (V)		Package Description	Package Option	Branding
		VOUT1	VOUT2			
ADP222ACPZ-1218-R7	-40°C to +125°C	1.2	1.8	8-Lead Lead Frame Chip Scale Package [LFCSP_UD]	CP-8-10	L16
ADP222ACPZ-1228-R7	-40°C to +125°C	1.2	2.8	8-Lead Lead Frame Chip Scale Package [LFCSP_UD]	CP-8-10	L17
ADP222ACPZ-1233-R7	-40°C to +125°C	1.2	3.3	8-Lead Lead Frame Chip Scale Package [LFCSP_UD]	CP-8-10	L18
ADP222ACPZ-1528-R7	-40°C to +125°C	1.5	2.8	8-Lead Lead Frame Chip Scale Package [LFCSP_UD]	CP-8-10	LKR
ADP222ACPZ-1533-R7	-40°C to +125°C	1.5	3.3	8-Lead Lead Frame Chip Scale Package [LFCSP_UD]	CP-8-10	LKS
ADP222ACPZ-1815-R7	-40°C to +125°C	1.8	1.5	8-Lead Lead Frame Chip Scale Package [LFCSP_UD]	CP-8-10	LL0
ADP222ACPZ-1825-R7	-40°C to +125°C	1.8	2.5	8-Lead Lead Frame Chip Scale Package [LFCSP_UD]	CP-8-10	LL1
ADP222ACPZ-1827-R7	-40°C to +125°C	1.8	2.7	8-Lead Lead Frame Chip Scale Package [LFCSP_UD]	CP-8-10	L3A
ADP222ACPZ-1833-R7	-40°C to +125°C	1.8	3.3	8-Lead Lead Frame Chip Scale Package [LFCSP_UD]	CP-8-10	LL2
ADP222ACPZ-2725-R7	-40°C to +125°C	2.7	2.5	8-Lead Lead Frame Chip Scale Package [LFCSP_UD]	CP-8-10	LN8
ADP222ACPZ-2818-R7	-40°C to +125°C	2.8	1.8	8-Lead Lead Frame Chip Scale Package [LFCSP_UD]	CP-8-10	LL3
ADP222ACPZ-2827-R7	-40°C to +125°C	2.8	2.7	8-Lead Lead Frame Chip Scale Package [LFCSP_UD]	CP-8-10	LJE
ADP222ACPZ-3325-R7	-40°C to +125°C	3.3	2.5	8-Lead Lead Frame Chip Scale Package [LFCSP_UD]	CP-8-10	LKV
ADP222ACPZ-3328-R7	-40°C to +125°C	3.3	2.8	8-Lead Lead Frame Chip Scale Package [LFCSP_UD]	CP-8-10	LKW
ADP222ACPZ-3330-R7	-40°C to +125°C	3.3	3.0	8-Lead Lead Frame Chip Scale Package [LFCSP_UD]	CP-8-10	LKX
ADP224ACPZ-2818-R7	-40°C to +125°C	2.8	1.8	8-Lead Lead Frame Chip Scale Package [LFCSP_UD]	CP-8-10	LKP
ADP225ACPZ-R7	-40°C to +125°C	Adjustable	Adjustable	8-Lead Lead Frame Chip Scale Package [LFCSP_UD]	CP-8-10	LKQ
ADP223ACPZ-R7	-40°C to +125°C	Adjustable	Adjustable	8-Lead Lead Frame Chip Scale Package [LFCSP_UD]	CP-8-10	LJQ
ADP223CP-EVALZ		Adjustable	Adjustable	Evaluation Board		
ADP225CP-EVALZ		Adjustable	Adjustable	Evaluation Board		

¹Z = RoHS Compliant Part.