

# Features

# Regulated Converters

- 2:1 Wide Input Voltage Range
- 1.6kVDC Isolation
- UL Certified
- Efficiency up to 87%
- Fixed Operating Frequency
- Six-Sided Continuous Shield



## RP10-E

**10 Watt**  
**2" x 1"**  
**Single & Dual Output**



### Description

The RP10-E series DC/DC converters are certified to UL 60950-1 and cUL 60950-1. This makes them ideal for all telecom and industrial applications where approved safety standards are required. The industry standard 2" x 1" package meets military standards for thermal shock and vibration tolerance and is available with an optional remote on/off control pin. This series is also available with the /M1 and /M2 option which is particularly suitable for extended temperature range applications.

### Selection Guide

Part Number	Input Voltage Range [VDC]	Output Voltage [VDC]	Output Current [mA]	Input <sup>(1)</sup> Current [mA]	Efficiency <sup>(1)</sup> typ. [%]	Max. Capacitive Load <sup>(2)</sup> [μF]
RP10-123.3SE <sup>(3,4)</sup>	9-18	3.3	2000	688	80	6800
RP10-1205SE <sup>(3,4)</sup>	9-18	5	2000	1029	81	4700
RP10-1212SE <sup>(3,4)</sup>	9-18	12	830	988	84	690
RP10-1215SE <sup>(3,4)</sup>	9-18	15	670	997	84	470
RP10-243.3SE <sup>(3,4)</sup>	18-36	3.3	2000	344	80	6800
RP10-2405SE <sup>(3,4)</sup>	18-36	5	2000	508	82	4700
RP10-2412SE <sup>(3,4)</sup>	18-36	12	830	494	84	690
RP10-2415SE <sup>(3,4)</sup>	18-36	15	670	499	84	470
RP10-483.3SE <sup>(3,4)</sup>	36-75	3.3	2000	172	80	6800
RP10-4805SE <sup>(3,4)</sup>	36-75	5	2000	248	84	4700
RP10-4812SE <sup>(3,4)</sup>	36-75	12	830	241	86	690
RP10-4815SE <sup>(3,4)</sup>	36-75	15	670	241	87	470
RP10-1205DE <sup>(3,4)</sup>	9-18	±5	±1000	992	84	±680
RP10-1212DE <sup>(3,4)</sup>	9-18	±12	±416	1002	83	±330
RP10-1215DE <sup>(3,4)</sup>	9-18	±15	±333	991	84	±110
RP10-2405DE <sup>(3,4)</sup>	18-36	±5	±1000	502	83	±680
RP10-2412DE <sup>(3,4)</sup>	18-36	±12	±416	489	85	±330
RP10-2415DE <sup>(3,4)</sup>	18-36	±15	±333	496	84	±110
RP10-4805DE <sup>(3,4)</sup>	36-75	±5	±1000	248	84	±680
RP10-4812DE <sup>(3,4)</sup>	36-75	±12	±416	242	86	±330
RP10-4815DE <sup>(3,4)</sup>	36-75	±15	±333	245	85	±110

#### Notes:

- Note1: Maximum value at nominal input voltage and full load.  
 Note2: Test by minimum Vin and constant resistor load.



### Model Numbering

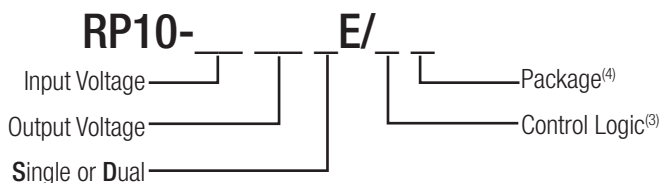

#### Ordering Examples:

- RP10-1205SE/P = 12V Input, 5V Output, Standard Temp. Range, Positive Logic CTRL pin fitted  
 RP10-4805DE/M1 -HC = 48V Input, 5V Output, Extended Temp. Range, No CTRL pin, Heat-sink fitted

#### Notes:

- Note3: add suffix "M1" for higher efficiencies and extended temperature range  
 add suffix "P" for CTRL function with Positive Logic (1=ON, 0=OFF)  
 add suffix "N" for CTRL function with Negative Logic (0=ON, 1=OFF)  
 Note4: add suffix -HC for premounted Heat-sink and clips



UL60950-1 Certified

**Specifications** measured at  $T_a = 25^\circ\text{C}$ , nominal input voltage, full load otherwise noted

**BASIC CHARACTERISTICS**

Parameter	Condition	Min.	Typ.	Max.
Input Voltage Range	nom. $V_{in} = 12\text{V}$	9VDVC	12VDC	18VDC
	nom. $V_{in} = 24\text{V}$	18VDC	24VDC	36VDC
	nom. $V_{in} = 48\text{V}$	36VDC	48VDC	75VDC
Under Voltage Lockout (UVLO)				none
Input Filter				Pi-Type
Input Reflected Ripple Current <sup>(5)</sup>	nominal $V_{in}$ and full load		30mA <sub>p-p</sub>	
Input Surge Voltage	12V input, 100ms max.			36VDC
	24V input, 100ms max.			50VDC
	48V input, 100ms max.			100VDC
Start-up time	nominal $V_{in}$ and constant resistor load Power up		20ms	
Operating Frequency Range		270kHz	300kHz	330kHz
Minimum Load <sup>(6)</sup>	of full load	10%		
Ripple and Noise	measured by 20MHz bandwidth	Single	50mV <sub>p-p</sub>	
		Dual	75mV <sub>p-p</sub>	
Remote ON/OFF <sup>(7)</sup>	Positive Logic	DC-DC ON DC-DC OFF	Open or $3.5\text{V} < V_r < 12\text{V}$ Short or $0\text{V} < V_r < 1.2\text{V}$	
	Negative Logic	DC-DC ON DC-DC OFF	Short or $0\text{V} < V_r < 1.2\text{V}$ Open or $3.5\text{V} < V_r < 12\text{V}$	
Input current of Remote pin (CTRL)		DC-DC OFF	20mA	
		DC-DC ON	-0.5mA	+1.0mA

**Notes:**

Note5: Simulated source impedance of  $12\mu\text{H}$ .  $12\mu\text{H}$  inductor in series with  $+V_{in}$ .

Note6: The RP10 (W) series required a minimum 10% loading on the output to maintain specified regulation. Operation under no-load condition will not damage these devices, however they may not meet all listed specification.

Note7: The ON/OFF control function can be positive or negative logic. The pin voltage is referenced to  $-V_{in}$  pin. If no suffix is specified, the control pin will be omitted.

**RP10-1205SE**

**Efficiency vs. Output Current**

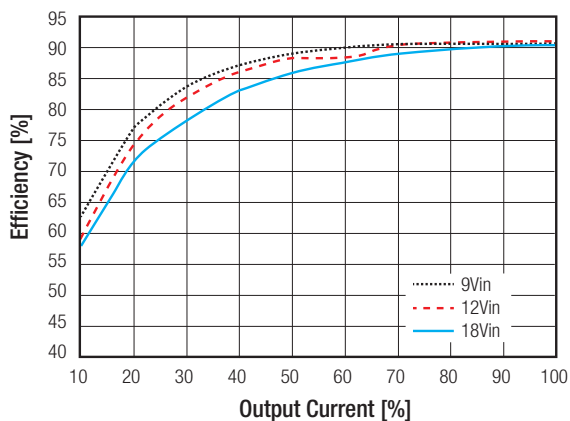

**Efficiency vs. Input Voltage**

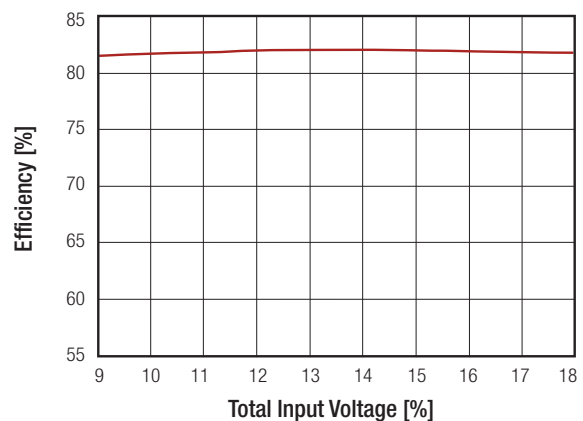

continued on next page

Specifications measured at Ta = 25°C, nominal input voltage, full load otherwise noted

**RP10-2405SE**

Efficiency vs. Output Current

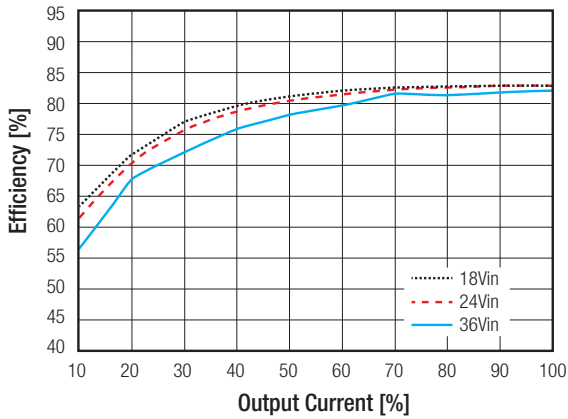

Efficiency vs. Input Voltage

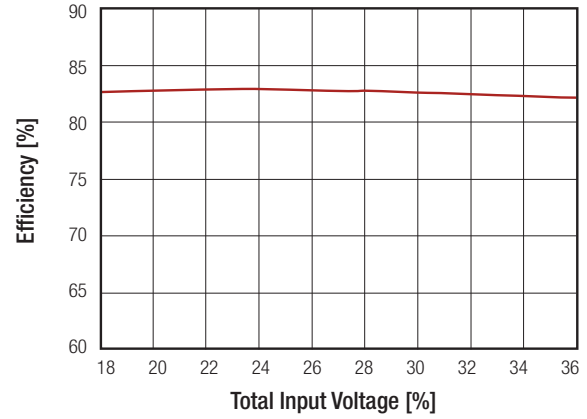

**RP10-4805SE**

Efficiency vs. Output Current

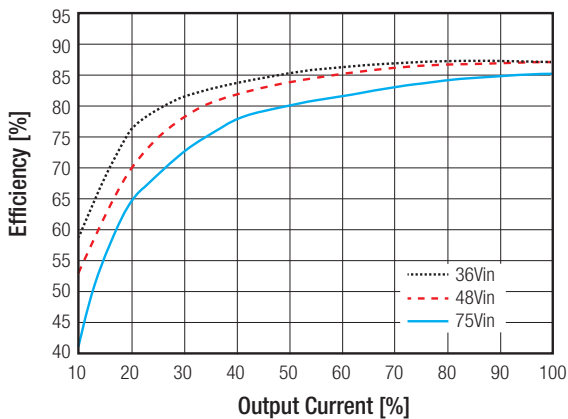

Efficiency vs. Input Voltage

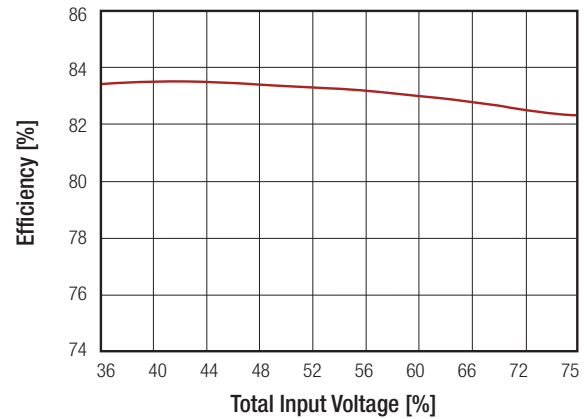

**REGULATIONS**

Parameter	Condition	Value	
Output Voltage Accuracy		±1%	
Line Voltage Regulation	low line to high line	±0.2%	
Load Voltage Regulation	0% to 100% load	Single Dual	±0.5% ±1.0%
Cross Regulation	asymmetrical 25% <-> 100% load	±5%	
Transient Response recovery time	25% load step change	250µs typ.	

**Specifications** measured at Ta = 25°C, nominal input voltage, full load otherwise noted

PROTECTIONS			
Parameter	Condition		Value
Short Circuit Protection (SCP)			continuous, automatic recovery
Over Voltage Protection (OVP)	Zener Diode Clamp	3.3Vout	3.9VDC typ.
		5Vout	6.2VDC typ.
		12Vout	15VDC typ.
		15Vout	18VDC typ.
Over Load Protection (OLP)	% of Iout rated		150% max.
Isolation Voltage	I/P to O/P		1.6kVDC/1 minute
	I/P (O/P) to case		1.6kVDC/1 minute
Isolation Resistance	500VDC		1GΩ min.
Isolation Capacitance			300pF max.
<p><b>Notes:</b></p> <p>Note8: This power module is not internally fused. An input line fuse must always be used.</p>			

ENVIRONMENTAL			
Parameter	Condition		Value
Operating Temperature Range (Reference Derating Curve) <sup>(9)</sup>	Standard	with derating	-25°C to +100°C
	M1	with derating	-40°C to +85°C
Maximum Case Temperature			+105°C
Temperature Coefficient			±0.02%/°C max.
Thermal Impedance	vertical direction by natural convection (20LFM)	without Heat-Sink with Heat-Sink	12°C/Watt 10°C/Watt
Operating Humidity	non-condensing		5% - 95% RH
Thermal Shock			MIL-STD-810F
Vibration			MIL-STD-810F
MTBF <sup>(10)</sup>	MIL-HDBK-217F, Full Load		3342 x10 <sup>3</sup> hours

**Derating Graph<sup>(9,11)</sup>**

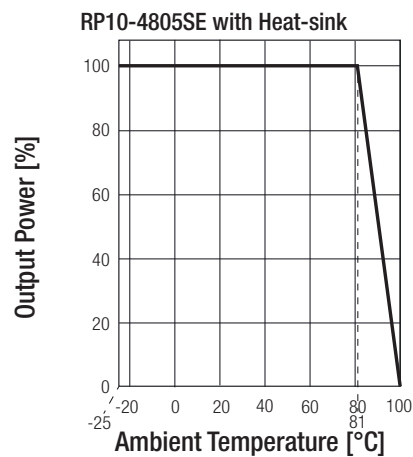
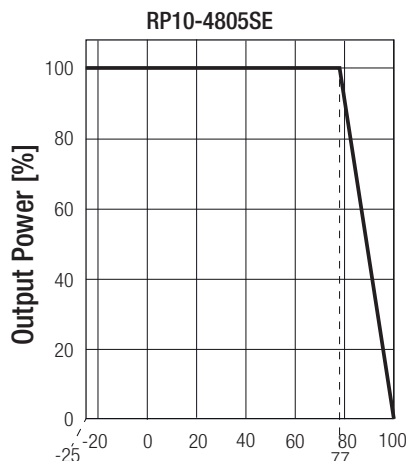

continued on next page

**Specifications** measured at Ta = 25°C, nominal input voltage, full load otherwise noted

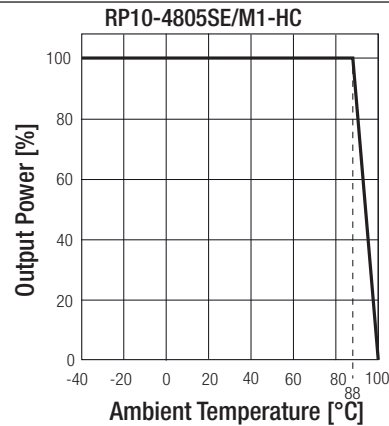
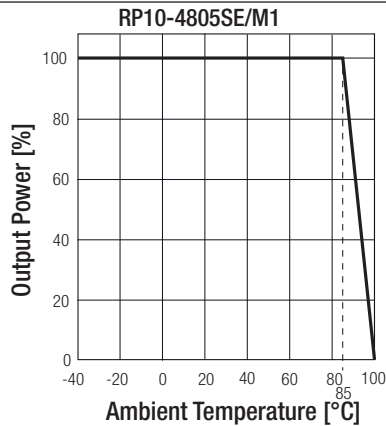

**Notes:**

- Note9: M1 version is more efficient, therefore, it can be operated in a more extensive temperature range than standard version.
- Note10: BELLCORE TR-NWT-000332. Case I: 50% Stress, Temperature at 40°C. (Ground fixed and controlled environment).
- Note11: Derating graphs are valid only for the shown part numbers. If you need detailed derating-information about a part-number not shown here please contact our technical support service at techsupportAT@recom-power.com.

### SAFETY AND CERTIFICATIONS

Certificate Type (Safety)	Report / File Number	Standard
UL General Safety	E196683	UL60950-1 1st Ed.: 2003 C22.2 No. 60950 1st. Ed.: 2003
EMC Compliance	Condition	Standard / Criterion
EMI Standard <sup>(12)</sup>	with external filter	EN55022, Class A or B
ESD	Air ±8kV and Contact ± 6kV	EN61000-4-2, Criteria B
Radiated Immunity	10 V/m	EN61000-4-3, Criteria A
Fast Transient <sup>(13)</sup>	±2kV	EN61000-4-4, Criteria B
Surge <sup>(13)</sup>	±2kV	EN61000-4-5, Criteria B
Conducted Immunity	10 Vr.m.s	EN61000-4-6, Criteria A

**Notes:**

- Note12: The standard modules meet EMI Class A or Class B with external components, see filter suggestions below.
- Note13: An external input filter capacitor is required if the module has to meet EN61000-4-4, EN61000-4-5. The filter capacitor Recom suggests: Nippon chemi-con KY series, 220µF/100V.

#### EMI Filtering Class A

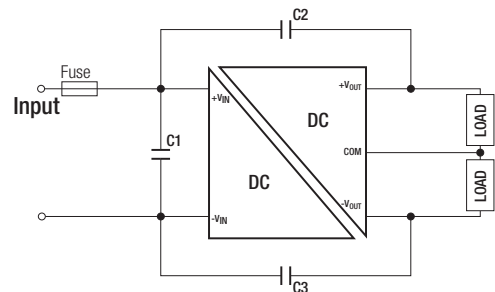
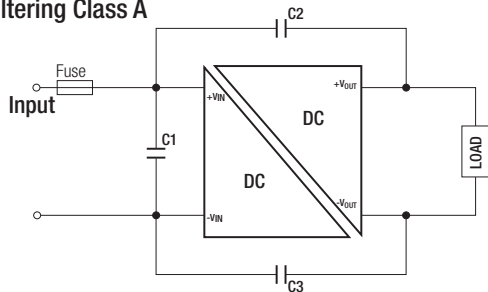

MODEL	C1	C2	C3
RP10-12xxS_DE	2.2µF/25V 1206 MLCC	1000pF/2kV 1808 MLCC	1000pF/2kV 1808 MLCC
RP10-24xxS_DE	N/A	1000pF/2kV 1808 MLCC	1000pF/2kV 1808 MLCC
RP10-48xxS_DE	N/A	1000pF/2kV 1808 MLCC	1000pF/2kV 1808 MLCC

continued on next page

Specifications measured at Ta = 25°C, nominal input voltage, full load otherwise noted

### EMI Filtering Class B

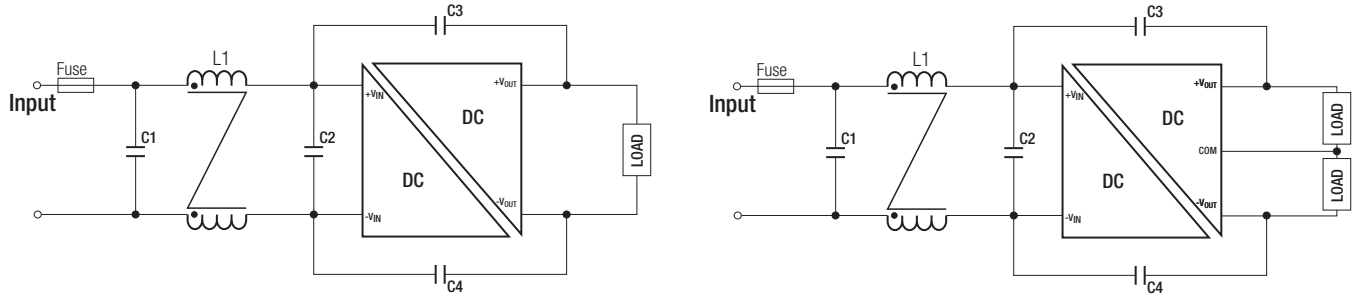

MODEL	C1	C2	C3/C4	L1
RP10-12xxS_DE	3.3µF/50V 1812 MLCC	N/A	1000pF/2kV 1808 MLCC	CMC: 325µH ref: WE 744290321 ref.: CMC-06
RP10-24xxS_DE	2.2µF/50V 1812 MLCC	N/A	1000pF/2kV 1808 MLCC	CMC: 325µH ref: WE 744290321 ref.: CMC-06
RP10-48xxS_DE	2.2µF/100V 1812 MLCC	2.2µF/100V 1812 MLCC	1000pF/2kV 1808 MLCC	CMC: 325µH ref: WE 744290321 ref.: CMC-06

### DIMENSIONS and PHYSICAL CHARACTERISTICS

Parameter	Type	Value
Material	Case	Nickel coated copper
	Base	Non-conductive black plastic
	Potting	Epoxy (UL94-V0)
Package Dimensions (LxWxH)	without Heat-sink	50.8 x 25.4 x 10.2mm
	with Heat-sink	56.8 x 25.4 x 16.8mm
Package Weight	without Heat-sink	27g
	with Heat-sink	37.89g

### Dimension Drawing (mm)

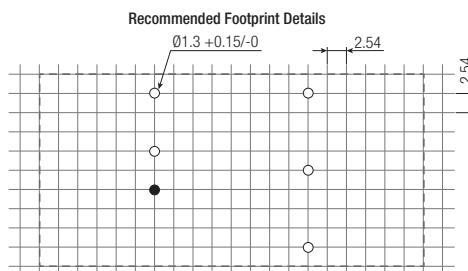
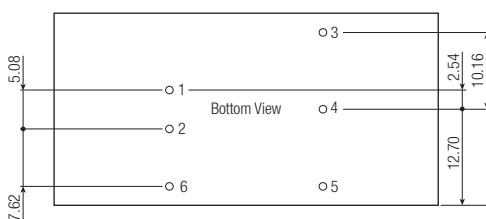
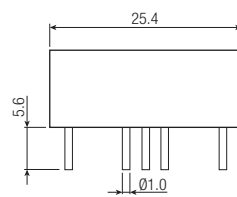
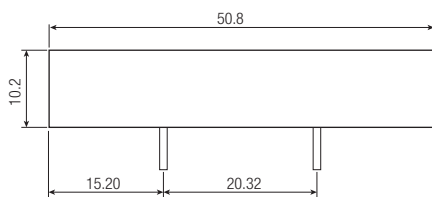
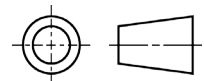

### Pin Connections

Pin #	Single	Dual
1	+Vin	+Vin
2	-Vin	-Vin
3	+Vout	+Vout
4	No Pin	Com
5	-Vout	-Vout
6	CTRL	CTRL

Pin Pitch Tolerance ±0.25mm  
 Pin dimension tolerance ±0.1mm  
 XX.X ± 0.5mm  
 XX.XX ± 0.25mm

continued on next page

**Specifications** measured at  $T_a = 25^\circ\text{C}$ , nominal input voltage, full load otherwise noted

Dimension Drawing (mm) with Heat-sink

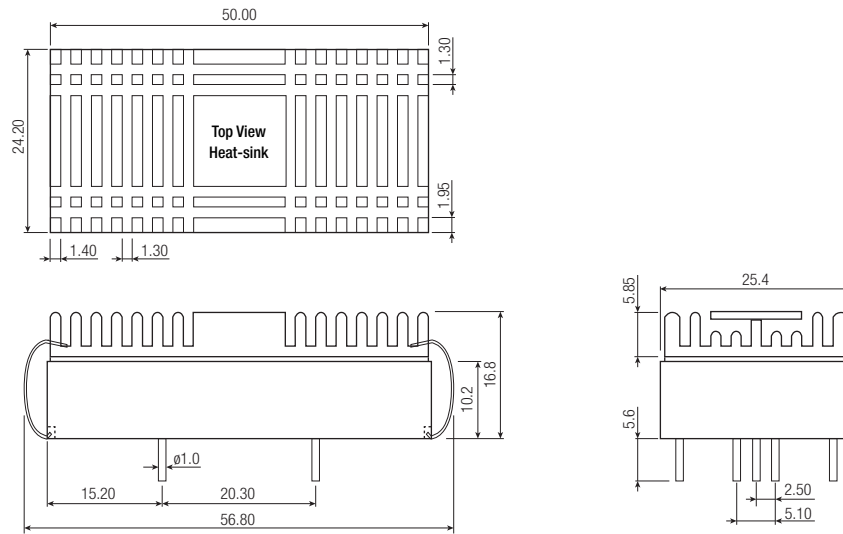

**PACKAGING INFORMATION**

Parameter	Type		Value
Packaging Quantity	without Heat-sink	Tube	9pcs.
	with Heat-sink	Tray	20pcs.
Storage Temperature Range			-55°C to +125°C
Storage Humidity			5% - 95% RH

The product information and specifications are subject to change without prior notice. RECOM products are not authorized for use in safety-critical applications (such as life support) without RECOM's explicit written consent. A safety-critical application is defined as an application where a failure of a RECOM product may reasonably be expected to endanger or cause loss of life, inflict bodily harm or damage property. The buyer shall indemnify and hold harmless RECOM, its affiliated companies and its representatives against any damage claims in connection with the unauthorized use of RECOM products in such safety-critical applications.

# Mouser Electronics

Authorized Distributor

Click to View Pricing, Inventory, Delivery & Lifecycle Information:

## RECOM:

[RP10-1205DE](#) [RP10-1205DE/M1](#) [RP10-1205DE/M1-HC](#) [RP10-1205DE/N](#) [RP10-1205DE/N/M1](#) [RP10-1205DE/N/M1-HC](#) [RP10-1205DE/N-HC](#) [RP10-1205DE/P](#) [RP10-1205DE/P/M1](#) [RP10-1205DE/P/M1-HC](#) [RP10-1205DE/P-HC](#) [RP10-1205DE-HC](#) [RP10-1205SE](#) [RP10-1205SE/M1](#) [RP10-1205SE/M1-HC](#) [RP10-1205SE/N](#) [RP10-1205SE/N/M1](#) [RP10-1205SE/N/M1-HC](#) [RP10-1205SE/N-HC](#) [RP10-1205SE/P](#) [RP10-1205SE/P/M1](#) [RP10-1205SE/P/M1-HC](#) [RP10-1205SE/P-HC](#) [RP10-1205SE-HC](#) [RP10-1212DE](#) [RP10-1212DE/M1](#) [RP10-1212DE/M1-HC](#) [RP10-1212DE/N](#) [RP10-1212DE/N/M1](#) [RP10-1212DE/N/M1-HC](#) [RP10-1212DE/N-HC](#) [RP10-1212DE/P](#) [RP10-1212DE/P/M1](#) [RP10-1212DE/P/M1-HC](#) [RP10-1212DE/P-HC](#) [RP10-1212DE-HC](#) [RP10-1212SE](#) [RP10-1212SE/M1](#) [RP10-1212SE/M1-HC](#) [RP10-1212SE/N](#) [RP10-1212SE/N/M1](#) [RP10-1212SE/N/M1-HC](#) [RP10-1212SE/N-HC](#) [RP10-1212SE/P](#) [RP10-1212SE/P/M1](#) [RP10-1212SE/P/M1-HC](#) [RP10-1212SE/P-HC](#) [RP10-1212SE-HC](#) [RP10-1215DE](#) [RP10-1215DE/M1](#) [RP10-1215DE/M1-HC](#) [RP10-1215DE/N](#) [RP10-1215DE/N/M1](#) [RP10-1215DE/N/M1-HC](#) [RP10-1215DE/N-HC](#) [RP10-1215DE/P](#) [RP10-1215DE/P/M1](#) [RP10-1215DE/P/M1-HC](#) [RP10-1215DE/P-HC](#) [RP10-1215DE-HC](#) [RP10-1215SE](#) [RP10-1215SE/M1](#) [RP10-1215SE/M1-HC](#) [RP10-1215SE/N](#) [RP10-1215SE/N/M1](#) [RP10-1215SE/N/M1-HC](#) [RP10-1215SE/N-HC](#) [RP10-1215SE/P](#) [RP10-1215SE/P/M1](#) [RP10-1215SE/P/M1-HC](#) [RP10-1215SE/P-HC](#) [RP10-1215SE-HC](#) [RP10-123.3SE](#) [RP10-123.3SE/M1](#) [RP10-123.3SE/M1-HC](#) [RP10-123.3SE/N](#) [RP10-123.3SE/N/M1](#) [RP10-123.3SE/N/M1-HC](#) [RP10-123.3SE/N-HC](#) [RP10-123.3SE/P](#) [RP10-123.3SE/P/M1](#) [RP10-123.3SE/P/M1-HC](#) [RP10-123.3SE/P-HC](#) [RP10-123.3SE-HC](#) [RP10-2405DE](#) [RP10-2405DE/M1](#) [RP10-2405DE/M1-HC](#) [RP10-2405DE/N](#) [RP10-2405DE/N/M1](#) [RP10-2405DE/N/M1-HC](#) [RP10-2405DE/N-HC](#) [RP10-2405DE/P](#) [RP10-2405DE/P/M1](#) [RP10-2405DE/P/M1-HC](#) [RP10-2405DE/P-HC](#) [RP10-2405DE-HC](#) [RP10-2405SE](#) [RP10-2405SE/M1](#) [RP10-2405SE/M1-HC](#) [RP10-2405SE/N](#)