

THIS DRAWING IS UNPUBLISHED. RELEASED FOR PUBLICATION
 © COPYRIGHT copyright.d8Te- ALL RIGHTS RESERVED.

REVISIONS				
P	LTR	DESCRIPTION	DATE	APVD
B3		REVISED PER ECR-16-013589	08OCT2016	NK DC

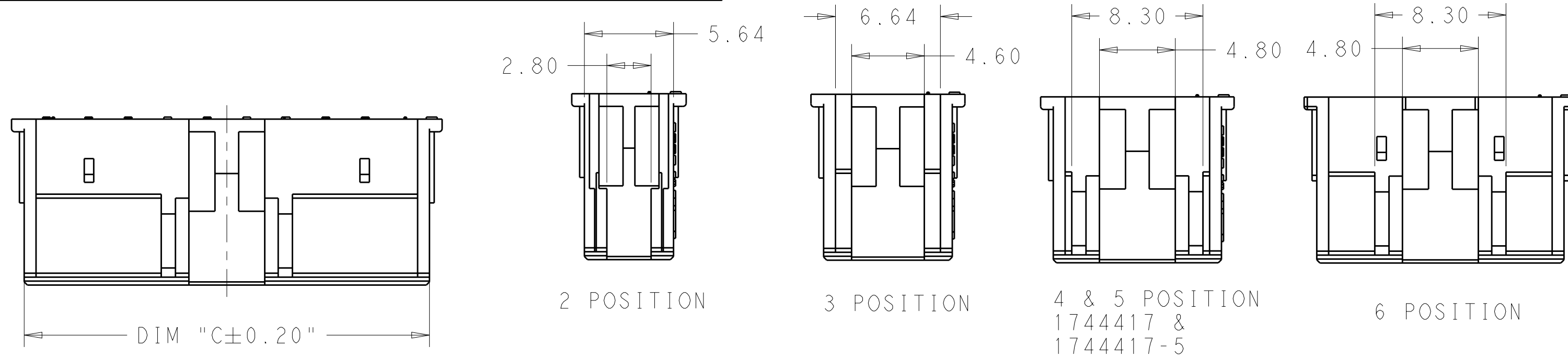

7 THRU 20 POSITION
1744417-X

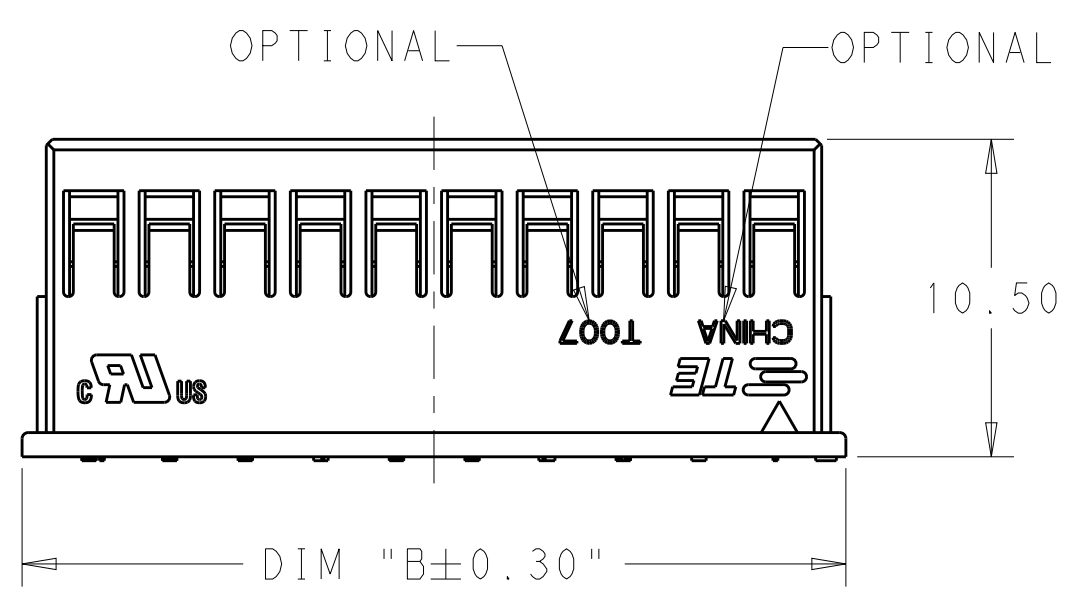
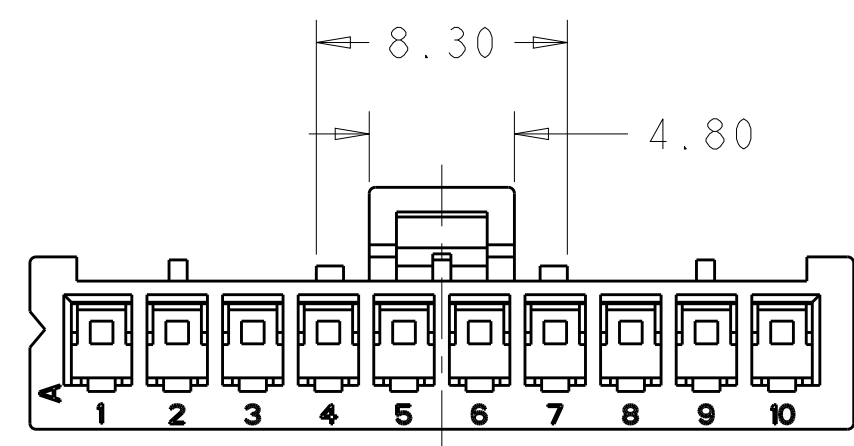
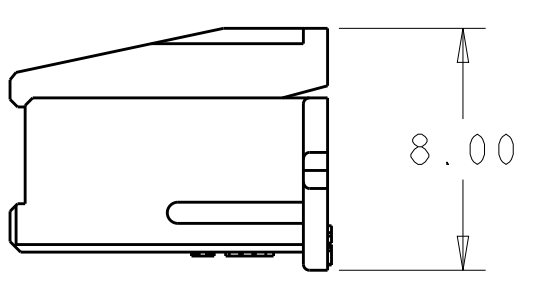
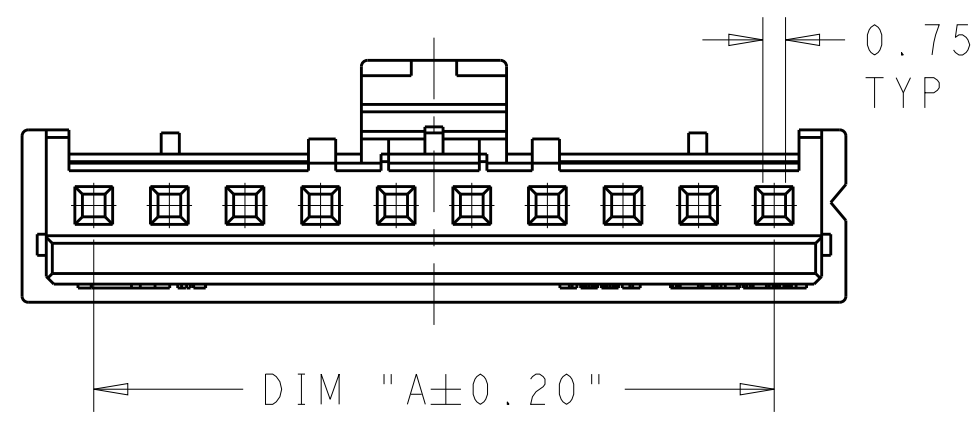

- 1 MATERIAL: NYLON UL94V-0
COLOR: NATURAL
- 2 ACCEPTS TE RECEPTACLE
P/N'S 2110989-()
- 3 THESE HOUSINGS CAN ACCEPT
OPTIONAL TPA (RETAINER)
P/N 1969443-().
- 4 MATES WITH TE HEADER ASSEMBLIES
2132230-() & 2132415-().
- 5 COMPLY WITH GLOW WIRE REQUIREMENTS
FOR PARTS OF NON-METALLIC
MATERIAL SUPPORTING A CURRENT-
CARRYING CONNECTION DETAILED IN
IEC 60335-1, SECTION 30(GWT).

50.64	52.3	47.5	20	2-1744417-0
48.14	49.8	45.0	19	1-1744417-9
45.64	47.3	42.5	18	1-1744417-8
43.14	44.8	40.0	17	1-1744417-7
40.64	42.3	37.5	16	1-1744417-6
38.14	39.8	35.0	15	1-1744417-5
35.64	37.3	32.5	14	1-1744417-4
33.14	34.8	30.0	13	1-1744417-3
30.64	32.3	27.5	12	1-1744417-2
28.14	29.8	25.0	11	1-1744417-1
25.64	27.3	22.5	10	1-1744417-0
23.14	24.8	20.0	9	1744417-9
20.64	22.3	17.5	8	1744417-8
18.14	19.8	15.0	7	1744417-7
15.64	17.3	12.5	6	1744417-6
13.14	14.8	10.0	5	1744417-5
10.64	12.3	7.5	4	1744417-4
8.14	9.8	5.0	3	1744417-3
5.64	7.3	2.5	2	1744417-2
DIM C	DIM B	DIM A	NO. OF POSITIONS	PART NUMBER

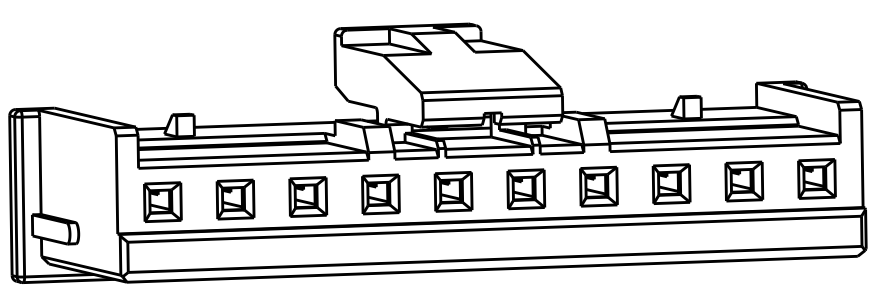

THIS DRAWING IS A CONTROLLED DOCUMENT.

DIMENSIONS:	TOLERANCES UNLESS OTHERWISE SPECIFIED:	DWN	JR RUTH	23APR15
mm	0 PLC ±	CHK	ASHWINI	23APR15
	1 PLC ±	APVD	ASHWINI	23APR15
	2 PLC ±0.25	PRODUCT SPEC		
	3 PLC ±	APPLICATION SPEC		
	4 PLC ±	WEIGHT		
	ANGLES ±	Customer Drawing		
	FINISH			

		TE Connectivity	
NAME: ECONOMY POWER 2.5 HOUSING GLOW WIRE			
SIZE	CAGE CODE	DRAWING NO	RESTRICTED TO
A2	-	C-1744417	-
SCALE	SHEET	OF	REV
5:1	1	1	B3

Mouser Electronics

Authorized Distributor

Click to View Pricing, Inventory, Delivery & Lifecycle Information:

[TE Connectivity:](#)

[1-1744417-0](#)