

DFC10 Series

Dual Output DC-DC Converters

The dual-output DFC10 Series provides power solutions to meet commercial and industrial requirements. With power densities above 11 watts per cubic inch (0.67 watts per cm³), overcurrent protection, and five-sided shielded case, the DFC10 meets rigorous needs in an industry-standard case size.

The 120 kHz operating frequency of the DFC10 Series allows an increased power density while including adequate heatsinking and input/output filtering. This eliminates the need for external components in most applications.

Full overload protection is provided by pulse-by-pulse current limiting on models with 48V input.



Key Features & Benefits

- RoHS compliant
- High power density, up to 11 watts per cubic inch (0.67 watts per cm³)
- Efficiencies up to 79%
- Fully-isolated, fully-filtered design
- Greater than 700 V isolation
- Overcurrent protection
- Five-sided, shielded copper case
- Ultra-wide range input (4:1)



bel POWER
SOLUTIONS &
PROTECTION

a bel group

belpowersolutions.com

1. MODEL SELECTION

MODEL	INPUT RANGE [VDC]			OUTPUT	
	MIN	MAX	[VDC]	[mA]	POWER [W]
DFC10U24D5	9	36	±5	±850	9
DFC10U24D12	9	36	±12	±400	10
DFC10U24D15	9	36	±15	±320	10
DFC10U48D12	18	72	±12	±415	10
DFC10U48D15	18	72	±15	±330	10

Model numbers highlighted in yellow are not recommended for new designs.

2. GENERAL SPECIFICATIONS ¹ – ALL MODELS

PARAMETER	CONDITIONS / DESCRIPTION	MIN	TYP	MAX	UNITS
Isolation ²					
Isolation Voltage	Input to Output	700			VDC
Leakage Current			10		μA
Capacitance	Input to Output		350		pF
Environmental					
Case Operating Range (T _c)	No Derating	-40		85	°C
Case Functional Range ³		-50		100	°C
Storage Range		-55		105	°C
Thermal Impedance ⁴			16		°C/W
General					
MTBF	Calculated		800000		hrs
Weight			1.2/34		oz/g

NOTES

- ¹ All parameters measured at T_c = 25°C, nominal input voltage and full rated load unless otherwise noted.
- ² Case is tied to the COMMON output pin.
- ³ The functional temperature range is intended to give an additional data point for use in evaluating this power supply. At the low functional temperature the power supply will function with no side effects, however, sustained operation at the high functional temperature will reduce expected operational life. The data sheet specifications are not guaranteed beyond the case operating range.
- ⁴ The case thermal impedance is specified as the case temperature rise over ambient per package watt dissipated.

3. INPUT SPECIFICATIONS¹

PARAMETER	CONDITIONS / DESCRIPTION	MIN	TYP	MAX	UNITS
Voltage Range	DFC10U24D5 / DFC10U24D12 / DFC10U24D15	9		36	VDC
	DFC10U48D12 / DFC10U48D15	18		72	
Input Current	Full Load / No Load	DFC10U24D5	450 / 10		mA
		DFC10U24D12 / DFC10U24D15	510 / 15		
		DFC10U48D12	265 / 4		
		DFC10U48D15	260 / 4		
Efficiency	DFC10U24D12 / DFC10U24D15 / DFC10U48D12 / DFC10U48D15	DFC10U24D5	79		%
		DFC10U24D12 / DFC10U24D15	78		
		DFC10U48D12 / DFC10U48D15	79		
Switching Frequency	DFC10U24D5 / DFC10U24D12 / DFC10U24D15		100		kHz
	DFC10U48D12 / DFC10U48D15		120		
Maximum Input Overvoltage, 100 ms maximum	DFC10U24D5 / DFC10U24D12 / DFC10U24D15 / DFC10U48D12 / DFC10U48D15			45 / 85	VDC
Turn -on Time, 1% Output Error			20		ms

4. OUTPUT SPECIFICATIONS¹

PARAMETER	CONDITIONS / DESCRIPTION	MIN	TYP	MAX	UNITS
Output Voltage	DFC10U24D5		±5		VDC
	DFC10U24D12 / DFC10U48D12		±12		
	DFC10U24D15 / DFC10U48D15		±15		
Output Voltage Accuracy	DFC10U24D5	±4.95	±5.00	±5.05	VDC
	DFC10U24D12 / DFC10U48D12	±11.90	±12.00	±12.10	
	DFC10U24D15 / DFC10U48D15	±14.90	±15.10	±15.10	
Rated Load Range ³	DFC10U24D5	0.0		±850	mA
	DFC10U24D12			±400	
	DFC10U48D12			±320	
	DFC10U24D15			±415	
	DFC10U48D15			±330	
Load Regulation ⁴ 25% Max Load - Max Load	DFC10U24D5 / DFC10U24D12 / DFC10U24D15		0.1	0.5	%
	DFC10U48D12 / DFC10U48D15		0.2	1.0	
Cross Regulation ⁵			3		%
Line Regulation	DFC10U24D5			0.7	%
	DFC10U24D12 / DFC10U24D15		0.1	0.3	
	DFC10U48D12 / DFC10U48D15			0.5	
Short Term Stability ⁶			< 0.01		% / 24 Hrs
Long Term Stability			< 0.1		% / kHrs
Noise, Peak-Peak ²			100		mV _{pp}
RMS Noise			35		mV _{rms}
Temperature Coefficient			50	250	ppm / °C
Short Circuit Protection	24 V Models: Short Term Current Limit 48 V Models: Pulse by Pulse Current Limit				

NOTES

- ¹ All parameters measured at T_c = 25°C, nominal input voltage and full rated load unless otherwise noted.
- ² Noise measurement bandwidth is 0-20 MHz. RMS noise is measured over a 0.01-1 MHz bandwidth. To simulate standard PCB decoupling practices, output noise is measured with a 10µf tantalum and 0.01µF ceramic capacitor located 1 inch away from the converter.
- ³ The converter may be safely operated at any load from zero to the full rating. Dynamic response of the converter may degrade if the converter is operated with less than 25% output load.
- ⁴ Load regulation is defined for loading/unloading both outputs simultaneously. Load range is 25 to 100%.
- ⁵ Cross regulation is defined for loading/unloading one output while the other output is kept at full load. Load range is 25 to 100%.
- ⁶ Short term stability is specified after a 30 minute warmup at full load, constant line and recording the drift over a 24 hour period.



Asia-Pacific **Europe, Middle East** **North America**
 +86 755 298 85888 +353 61 225 977 +1 408 785 5200

5. DFC10 SERIES APPLICATION NOTES

EXTERNAL CAPACITANCE REQUIREMENTS:

No external capacitance is required for operation of the DFC10 Series. If a capacitive input source is farther than 1" from the converter, an additional capacitor may be required at the input pins for proper operation.

This input capacitor should have an ESR greater than 0.25 ohms. Input capacitors with an ESR less than 0.25 ohms may cause peaking of the input filter and actually degrade circuit performance.

External output capacitance is not required for operation. However, it is recommended that 1 μF to 10 μF of tantalum and 0.001 to 0.1 μF ceramic capacitance be selected for reduced system noise. Additional output capacitance may be added for increased filtering, but should not exceed 400 μF .

24 VOLT INPUT MODELS

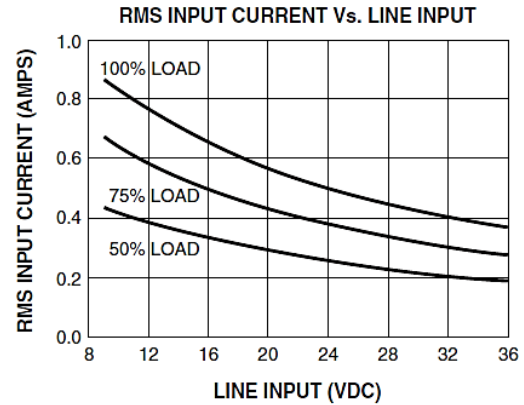
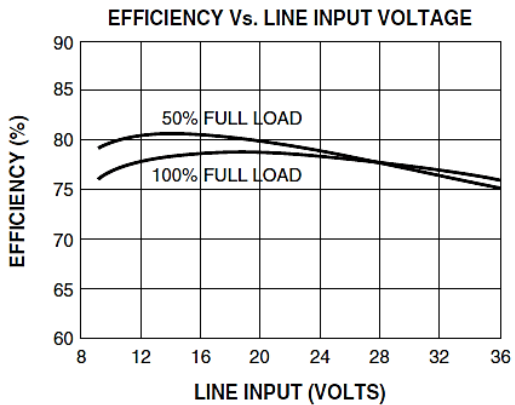
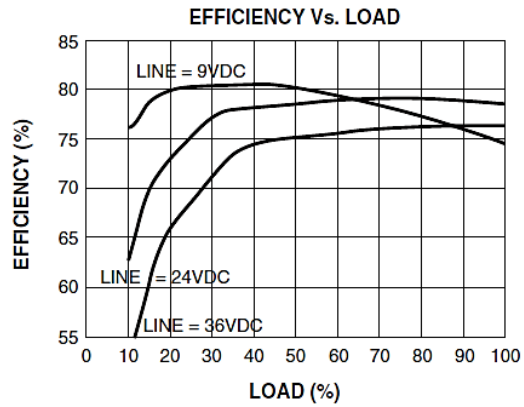
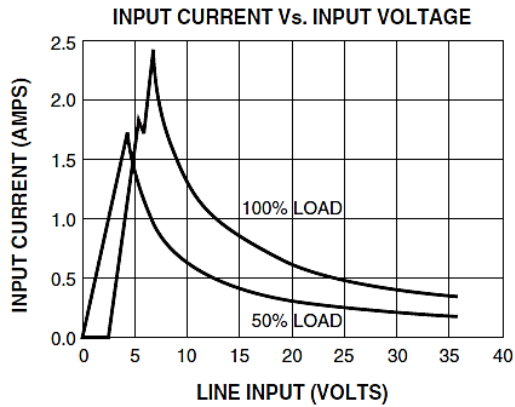

48 VOLT INPUT MODELS

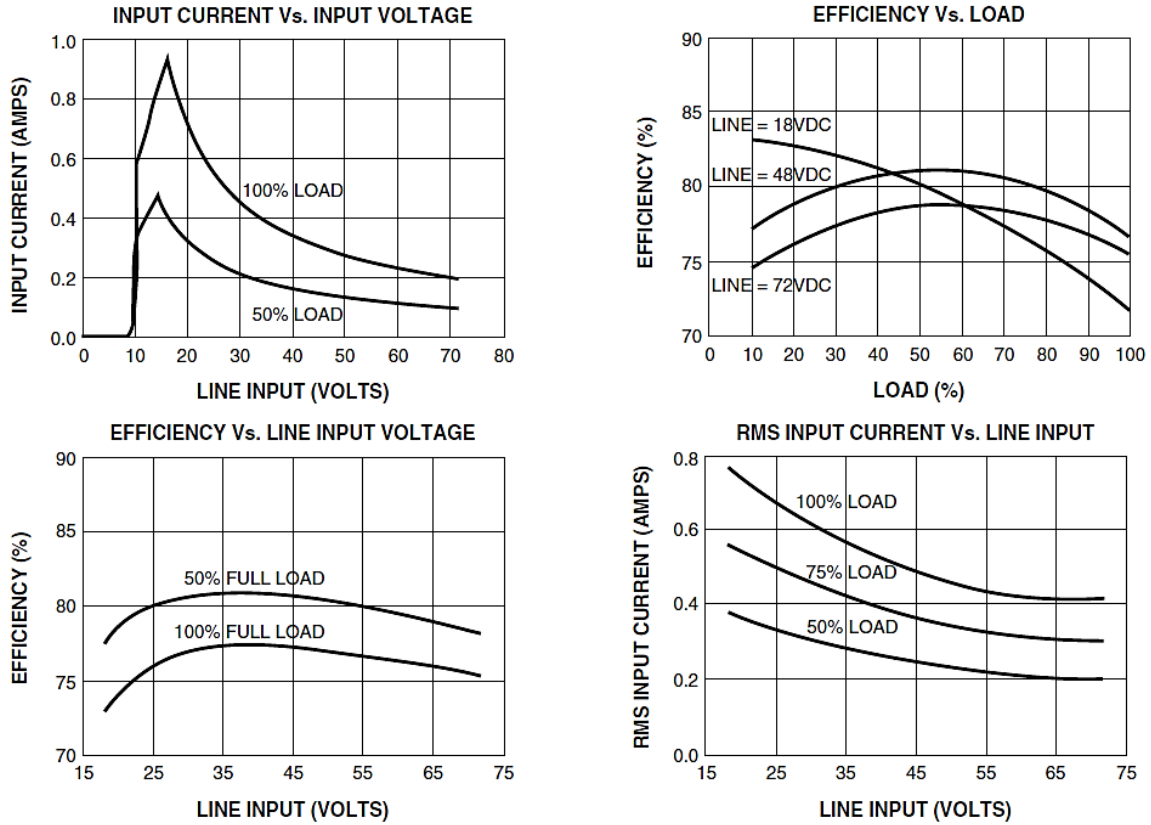

Figure 1. Typical Performance ($T_c = 25^\circ\text{C}$, $V_{in} = \text{Nom VDC}$, Rated Load)

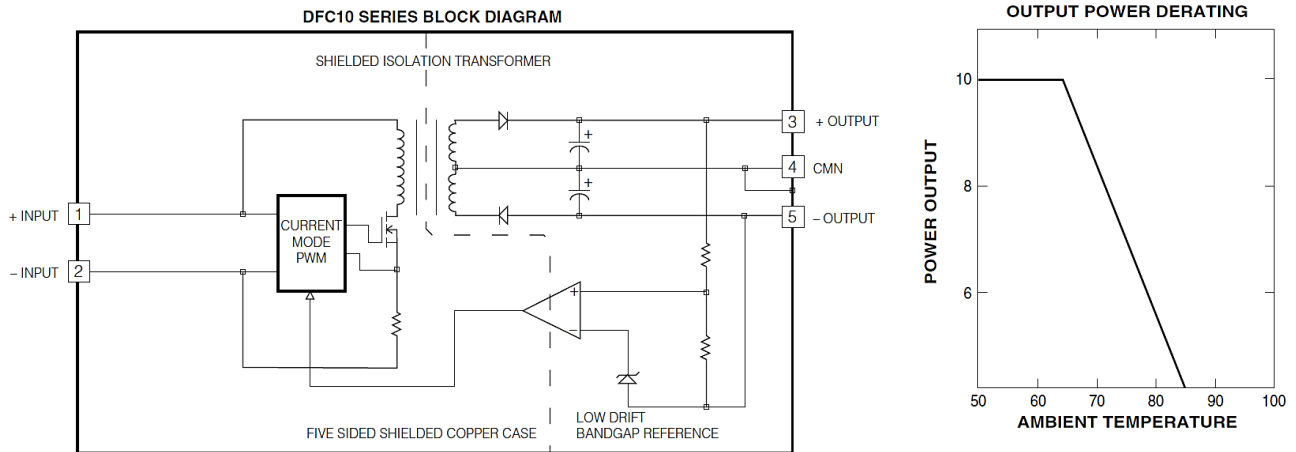

Figure 2. Typical Performance: ($T_c = 25^\circ\text{C}$, $V_{in} = \text{Nom VDC}$, Rated Load)

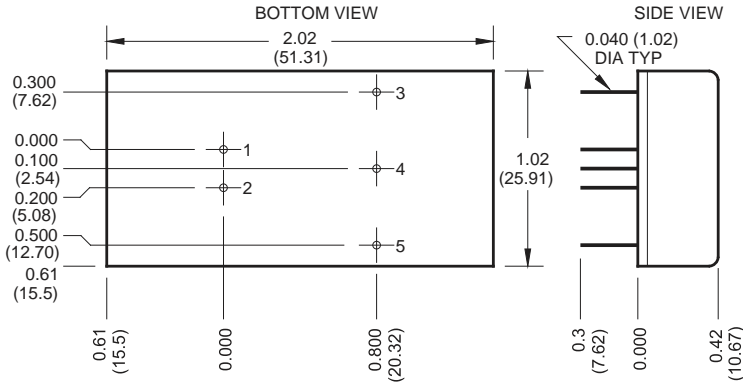

Figure 3. Mechanical Dimensions

PIN	FUNCTION
1	+ INPUT
2	- INPUT
3	+ OUTPUT
4	COMMON
5	- OUTPUT

Mechanical tolerances unless otherwise noted:

X.XX dimensions: ± 0.030 inches
 X.XXX dimensions: ± 0.005 inches

For more information on these products consult: tech.support@psbel.com

NUCLEAR AND MEDICAL APPLICATIONS - Products are not designed or intended for use as critical components in life support systems, equipment used in hazardous environments, or nuclear control systems.

TECHNICAL REVISIONS - The appearance of products, including safety agency certifications pictured on labels, may change depending on the date manufactured. Specifications are subject to change without notice.

Mouser Electronics

Authorized Distributor

Click to View Pricing, Inventory, Delivery & Lifecycle Information:

[Bel Power Solutions:](#)

[DFC10U48D15](#) [DFC10U24D5](#) [DFC10U48D12](#) [DFC10U24D15](#) [DFC10U24D12](#)