

APT2012P3BT

2.0 x 1.25 mm Phototransistor

DESCRIPTION

- Made with NPN silicon phototransistor chips

FEATURES

- 2.0 mm x 1.25 mm SMD LED, 0.75 mm thickness
- Mechanically and spectrally matched to infrared emitting LED lamp
- Blue transparent lens
- Package: 2000 pcs / reel
- Moisture sensitivity level: 3
- RoHS compliant

APPLICATIONS

- Infrared applied systems
- Optoelectronic switches
- Photodetector control circuits
- Sensor technology

PACKAGE DIMENSIONS

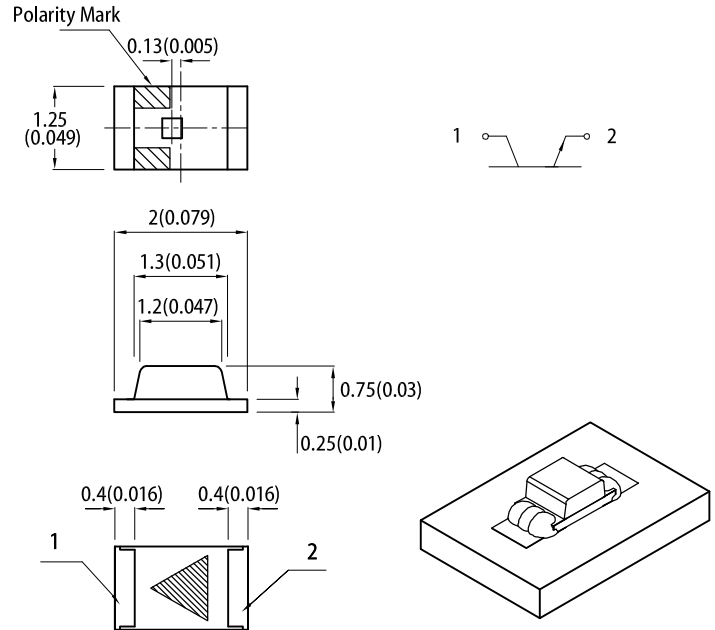

RECOMMENDED SOLDERING PATTERN

(units : mm; tolerance : ± 0.1)



Notes:

- All dimensions are in millimeters (inches).
- Tolerance is ±0.1(0.004") unless otherwise noted.
- The specifications, characteristics and technical data described in the datasheet are subject to change without prior notice.
- The device has a single mounting surface. The device must be mounted according to the specifications.

ABSOLUTE MAXIMUM RATINGS at T_A=25°C

| Parameter | Max.Ratings | Units |
|--|-------------|-------|
| Collector-to-Emitter Voltage | 30 | V |
| Emitter-to-Collector Voltage | 5 | V |
| Power Dissipation at(or below) 25°C Free Air Temperature | 100 | mW |
| Operating Temperature | -40 to +85 | °C |
| Storage Temperature | -40 to +85 | °C |

Note:

- Relative humidity levels maintained between 40% and 60% in production area are recommended to avoid the build-up of static electricity – Ref JEDEC/JESD625-A and JEDEC/J-STD-033.

ELECTRICAL / OPTICAL CHARACTERISTICS at $T_A=25^\circ\text{C}$

| Parameter | Symbol | Min. | Typ. | Max. | Units | Test Conditions |
|---|-----------------|------|------|------|---------------|--|
| Collector-to-Emitter Breakdown Voltage | $V_{BR\ CE0}$ | 30 | - | - | V | $I_C = 100\mu\text{A}$ $E_e = 0\text{mW}/\text{cm}^2$ |
| Emitter-to-Collector Breakdown Voltage | $V_{BR\ EC0}$ | 5 | - | - | V | $I_E = 100\mu\text{A}$ $E_e = 0\text{mW}/\text{cm}^2$ |
| Collector-to-Emitter Saturation Voltage | $V_{CE(SAT)}$ | - | - | 0.8 | V | $I_C = 2\text{mA}$ $E_e = 20\text{mW}/\text{cm}^2$ |
| Collector Dark Current | I_{CEO} | - | - | 100 | nA | $V_{CE} = 10\text{V}$ $E_e = 0\text{mW}/\text{cm}^2$ |
| Rise Time(10% to 90%) | T_R | - | 15 | - | μS | $V_{CE} = 5\text{V}$ $I_C = 1\text{mA}$ $R_L = 1000\Omega$ |
| Fall Time(90% to 10%) | T_F | - | 15 | - | μS | |
| On State Collector Current | $I_{(ON)}$ | 0.1 | 0.3 | - | mA | $V_{CE} = 5\text{V}$ $E_e = 1\text{mW}/\text{cm}^2$ $\lambda = 940\text{nm}$ |
| Range of spectral bandwidth | $\lambda_{0.1}$ | 670 | - | 1070 | nm | - |
| Wavelength of peak Sensitivity | λ_p | - | 940 | - | nm | - |
| Angle of half sensitivity | $2\theta_{1/2}$ | - | 160 | - | deg | - |

TECHNICAL DATA

RELATIVE SPECTRAL SENSITIVITY vs. WAVELENGTH

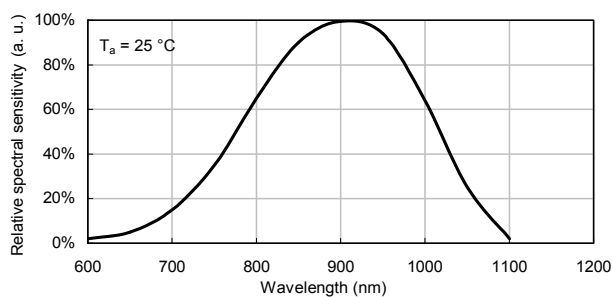

RELATIVE RADIANT SENSITIVITY vs. ANGULAR DISPLACEMENT

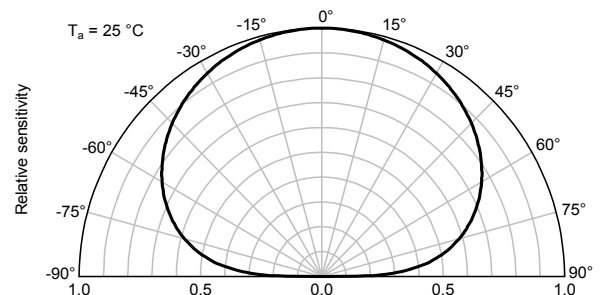

TECHNICAL DATA

PHOTOTRANSISTOR

Collector Current vs. Irradiance

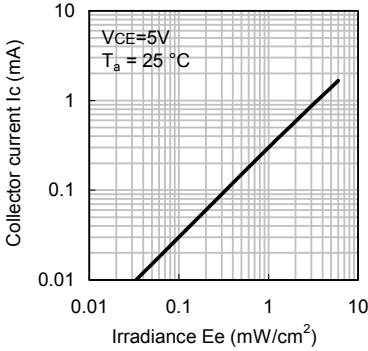

Collector Current vs. Collector-Emitter Voltage

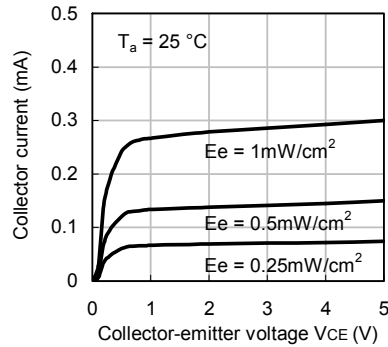

Relative Collector Current vs. Ambient Temperature

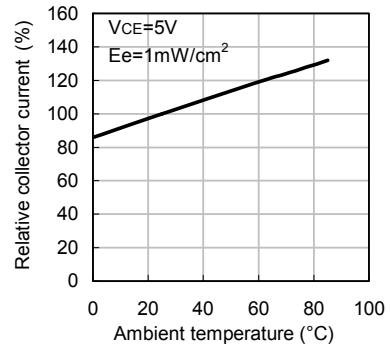

Collector Dark Current vs. Ambient Temperature

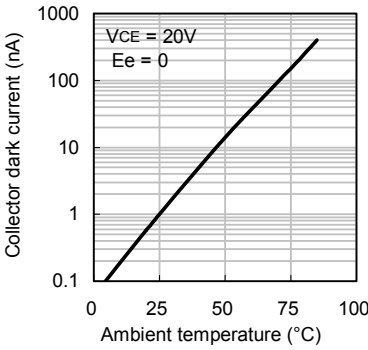

Collector Power Dissipation vs. Ambient Temperature

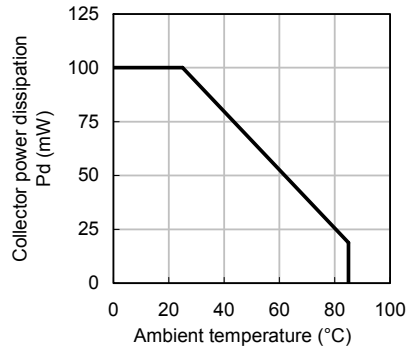

Collector Dark Current vs. Collector-Emitter Voltage

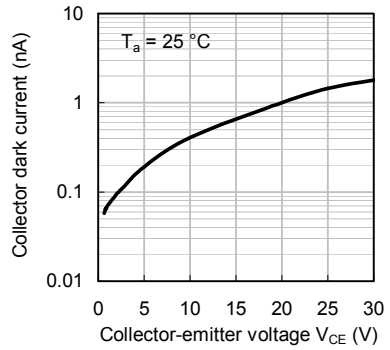

REFLOW SOLDERING PROFILE for LEAD-FREE SMD PROCESS

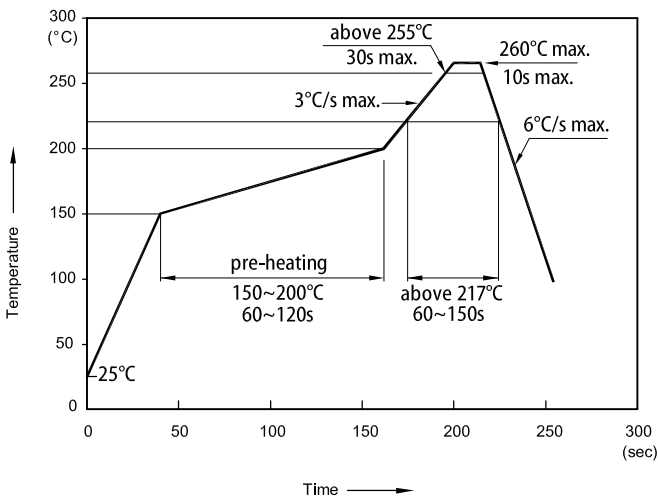

TAPE SPECIFICATIONS (units : mm)

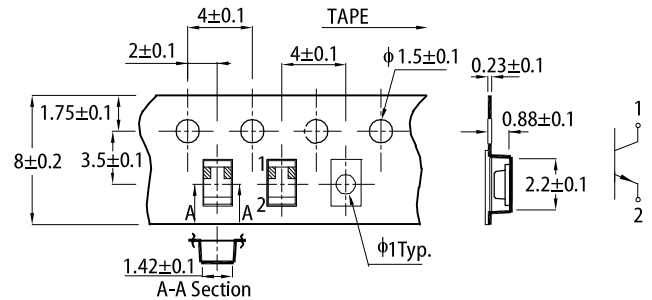

REEL DIMENSION (units : mm)

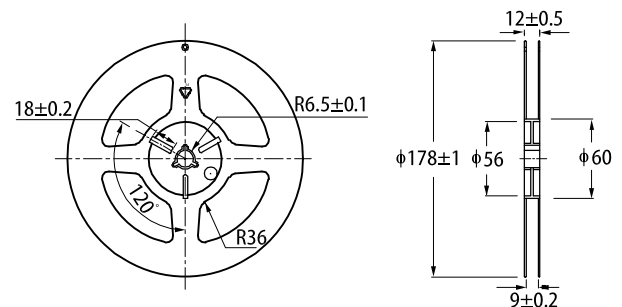

- Notes:
1. Don't cause stress to the LEDs while it is exposed to high temperature.
 2. The maximum number of reflow soldering passes is 2 times.
 3. Reflow soldering is recommended. Other soldering methods are not recommended as they might cause damage to the product.

PACKING & LABEL SPECIFICATIONS

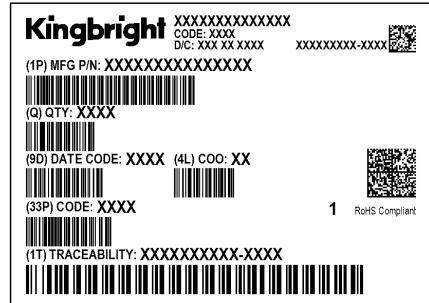
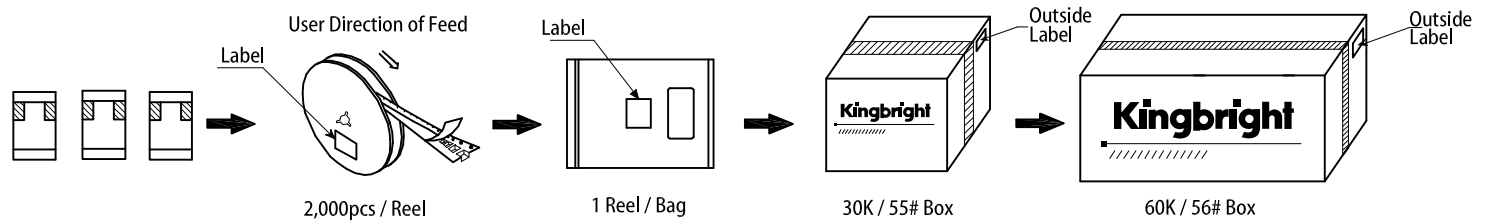

PRECAUTIONARY NOTES

1. The information included in this document reflects representative usage scenarios and is intended for technical reference only.
2. The part number, type, and specifications mentioned in this document are subject to future change and improvement without notice. Before production usage customer should refer to the latest datasheet for the updated specifications.
3. When using the products referenced in this document, please make sure the product is being operated within the environmental and electrical limits specified in the datasheet. If customer usage exceeds the specified limits, Kingbright will not be responsible for any subsequent issues.
4. The information in this document applies to typical usage in consumer electronics applications. If customer's application has special reliability requirements or have life-threatening liabilities, such as automotive or medical usage, please consult with Kingbright representative for further assistance.
5. The contents and information of this document may not be reproduced or re-transmitted without permission by Kingbright.
6. All design applications should refer to Kingbright application notes available at <http://www.KingbrightUSA.com/ApplicationNotes>

Mouser Electronics

Authorized Distributor

Click to View Pricing, Inventory, Delivery & Lifecycle Information:

[Kingbright:](#)

[APT2012P3BT](#)